



CATALOG 2024



About Future Oriented Surgical

Introduction

Welcome to Future Oriented Surgical, where innovation meets excellence in the realm of medical and healthcare instruments. Based in Ontario, Canada, we are dedicated to providing top-quality surgical, dental, and beauty instruments to healthcare professionals around the globe. Our commitment to precision, quality, and customer satisfaction sets us apart as a leader in the industry.

Our Expertise

With decades of combined experience, our team of skilled craftsmen, engineers, and professionals brings unparalleled expertise to the design, manufacture, and distribution of medical instruments. Each product undergoes rigorous quality control processes to ensure it meets our stringent standards and exceeds our customers' expectations.

Our Values

Integrity: We conduct our business with honesty, transparency, and accountability.

Excellence: We are committed to achieving the highest standards in everything we do.

Innovation: We embrace cutting-edge technology and continuous improvement.

Collaboration: We value partnerships and teamwork, both within our organization and with our clients.

Our Mission

Our mission at Future Oriented Surgical is to empower healthcare professionals with the highest quality instruments, enabling them to deliver exceptional care and achieve the best possible patient outcomes.

Our Vision

We envision a future where Future Oriented Surgical is synonymous with excellence in healthcare instrumentation worldwide. We aim to be the trusted partner of choice for healthcare professionals.

Our Expertise

With decades of combined experience, our team of skilled craftsmen, engineers, and professionals brings unparalleled expertise to the design, manufacture, and distribution of medical instruments. Each product undergoes rigorous quality control processes to ensure it meets our stringent standards and exceeds our customers' expectations.

Product Range

At Future Oriented Surgical, we take pride in offering a diverse and comprehensive range of high-quality instruments designed to meet the unique needs of healthcare professionals. Our product range encompasses surgical, dental, and beauty instruments, each crafted with precision and care to ensure exceptional performance and reliability.

Surgical Instruments

Our surgical instruments are engineered to support a wide array of medical procedures, from routine operations to complex surgeries. Each instrument is designed with the utmost attention to detail, ensuring precision, durability, and ease of use.

Scalpels and Blades: Sharp, precise, and reliable, our scalpels and blades are essential tools for any surgical procedure.

Forceps: Available in various designs and sizes, our forceps provide optimal control and grip for delicate tasks.

Retractors: Designed to hold back tissues and organs, our retractors offer excellent visibility and access during surgeries.

Needle Holders: Engineered for precision suturing, our needle holders ensure secure and accurate needle manipulation.

Scissors: Our surgical scissors, including curved and straight varieties, are designed for precise cutting and dissection.

Dental Instruments

Our dental instruments are tailored to meet the demands of modern dental practices, providing dentists with the tools they need to deliver top-notch care and achieve excellent patient outcomes.

Diagnostic Instruments: From mirrors and explorers to probes, our diagnostic tools aid in accurate assessment and diagnosis.

Extraction Forceps: Crafted for strength and precision, our extraction forceps ensure efficient and safe tooth removal.

Periodontal Instruments: Our range of scalers and curettes are designed to effectively remove plaque and tartar, promoting oral health.

Endodontic Instruments: High-quality files, reamers, and spreaders for effective root canal treatments.

Orthodontic Tools: Precision pliers, cutters, and other instruments for orthodontic procedures and adjustments.

Beauty Instruments

Our beauty instruments are meticulously crafted to support beauty professionals in delivering outstanding results. Each tool combines functionality with elegance, ensuring a superior user experience.

Tweezers: Precision-engineered tweezers for flawless hair removal and grooming.

Scissors: Professional-grade scissors for cutting and shaping, ideal for use in salons and spas.

Nail Care Tools: High-quality nail clippers, cuticle pushers, and files designed for meticulous nail care.

Comedone Extractors: Effective and safe tools for removing blackheads and whiteheads, promoting clear skin.

Manicure and Pedicure Kits: Comprehensive kits equipped with all the essential tools for professional manicures and pedicures.

Global Reach

While our roots are in Canada, our reach is global. We serve healthcare professionals and institutions worldwide, providing them with the tools they need to succeed. Through our extensive network of distributors and partners, we ensure our products are available wherever they are needed.

Customer Commitment

At Future Oriented Surgical, customer satisfaction is our top priority. We are dedicated to providing exceptional service, from personalized consultations to prompt and reliable support. Our goal is to build lasting relationships with our clients, based on trust, quality, and mutual success.

Quality and Innovation

At Future Oriented Surgical, quality and innovation are at the heart of our product development. We use the finest materials and advanced manufacturing techniques to produce instruments that meet the highest standards of performance and durability. Our commitment to continuous improvement ensures that we stay at the forefront of the industry, delivering cutting-edge solutions that enhance the capabilities of healthcare professionals.

Customization and Personalization

Understanding that every practice has unique needs, we offer customization options to tailor our instruments to your specific requirements. Whether it's a specialized tool or a personalized instrument set, our team is dedicated to providing solutions that meet your exact specifications.

Explore Our Product Range

Discover the Future Oriented Surgical difference by exploring our extensive product range. Whether you are a surgeon, dentist, or beauty professional, our instruments are designed to empower you to deliver exceptional care and achieve outstanding results. Contact us today to learn more about our products and how we can support your practice or institution.

Contact Us

Ready to experience the Future Oriented Surgical difference? Contact us today to learn more about our products and services, and discover how we can support your practice or institution. We look forward to partnering with you on your journey to excellence in healthcare.





Stainless Steel Dental Instruments Set

This high-quality set of dental instruments is crafted from premium stainless steel, ensuring durability and precision in various dental procedures. The ergonomic design provides a comfortable grip, allowing for enhanced control and accuracy. Each tool features a distinct blue and silver color scheme, making them easily distinguishable and adding a touch of sophistication to any dental practice.

Set Includes:

Scaler: Used for removing calculus from teeth surfaces.

Curette: Designed for subgingival scaling and root planing.

Explorer: Ideal for detecting caries and calculus, exploring pockets, and identifying restoration margins.

Periodontal Probe: Utilized for measuring pocket depths around teeth.

Burnisher: Helps in smoothing and polishing dental restorations.

Plastic Filling Instrument: Used for placing and contouring dental composite materials.



Premium Surgical Needle Holder Set

Introducing our Premium Surgical Needle Holder Set, expertly crafted for precision and durability in various surgical procedures. These instruments are designed for optimal performance, ensuring that surgeons can perform with confidence and accuracy. The set includes a variety of needle holders, each tailored to specific tasks, featuring ergonomic designs and high-quality materials.

Set Includes:

Castroviejo Needle Holder (Curved): Ideal for delicate surgeries requiring precise needle manipulation, such as ophthalmic or vascular procedures.

Mathieu Needle Holder: Known for its spring-action handle, this holder is perfect for securing and guiding needles during suturing.

Mayo-Hegar Needle Holder: A versatile tool commonly used in general surgeries for holding medium to heavy needles.

Micro Needle Holder: Specifically designed for microsurgical procedures, providing exceptional control for fine suturing.



General Instruments

Artery Forceps	14
Clamps	17
Spring Forceps	19
Tissue Forceps	20
Sponge Holding and Sterilising Forceps	22
Other Forceps	23
Scissors	24
Needle Holders	29
Combined Scissor and Needle Holders	33
Bag and Towel Clips	34
Retractors	35
Dissectors and Probes	43
Miscellaneous	44
Hollow Ware	45
Silicone Matting	46
Sterilising Baskets	46
Optical Fibre Cables	48

Artery Forceps

Adson Artery Forceps

Box joint, 180mm long

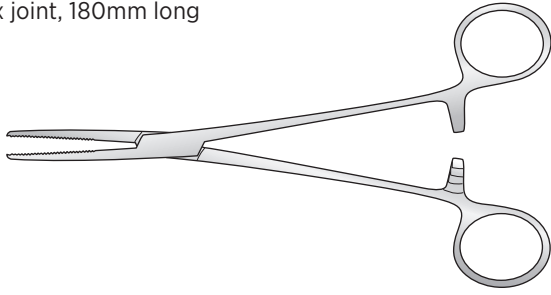

Serrated jaws

Code	Description
fos-GI/034	Straight
fos-GI/034a	Curved

1-2 teeth

Code	Description
fos-GI/034b	Straight
fos-GI/034c	Curved

Cushing Artery Forceps

Box joint, fine, half serrated jaws, 140mm long

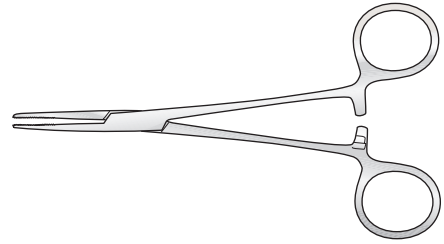

Code	Description
fos-GI/001	Straight
fos-GI/002	Curved

Cairns Artery Forceps

Box joint, half serrated jaws
145mm long

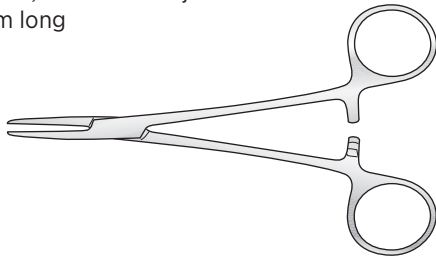

Serrated jaws

Code	Description
fos-GI/415	Straight

1-2 teeth

Code	Description
fos-GI/020	Curved
fos-GI/021	Curved to side

Dunhill Artery Forceps

Box joint, fine serrations

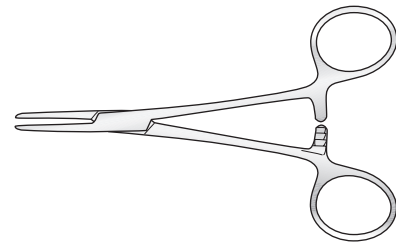

Straight

Code	Description
fos-GI/065	135mm long
fos-GI/065a	190mm long

Curved

Code	Description
fos-GI/043	135mm long
fos-GI/468	180mm long

Crile Artery Forceps

Box joint, serrated jaws

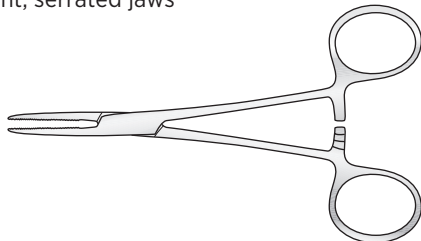

Straight

Code	Description
fos-GI/014	140mm long
fos-GI/014a	160mm long

Curved

Code	Description
fos-GI/015	140mm long
fos-GI/015a	160mm long

Lawson Tait Artery Forcep

Box joint, straight jaw

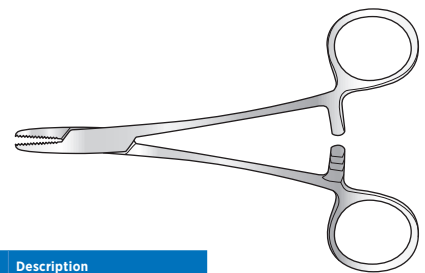

Code	Description
fos-GI/SH5924	140mm long

Artery Forceps

Halstead Mosquito Forceps

Standard pattern, haemostatic, box joint

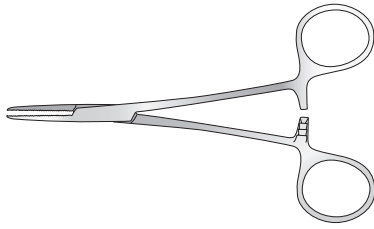

Serrated jaw

Code	Description
fos-GI/007	Straight 125mm long
fos-GI/008	Curved 125mm long
fos-GI/009	Fully curved 125mm long

1-2 teeth

Code	Description
fos-GI/010	Straight 125mm long
fos-GI/012	Straight 190mm long
fos-GI/011	Curved 125mm long
fos-GI/013	Curved 190mm long

Micro, 100mm long

Code	Description
fos-GI/003	Straight, serrated
fos-GI/004	Curved, serrated
fos-GI/005	Straight, 1-2 teeth
fos-GI/006	Curved, 1-2 teeth

Kelly Artery Forceps

Box joint, half serrated jaws



Straight

Code	Description
fos-GI/022	140mm long
fos-GI/023	160mm long

Curved

Code	Description
fos-GI/024	140mm long
fos-GI/025	160mm long

Fraser Kelly Artery Forceps Curved

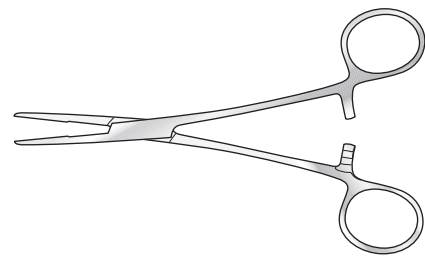

Straight

Code	Description
fos-GI/468a	180mm

Heiss Artery Forceps

Box joint, 205mm long

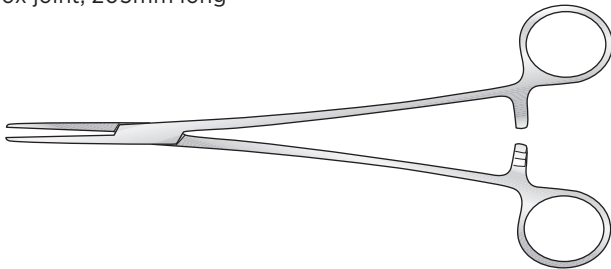

Serrated jaws

Code	Description
fos-GI/016	Straight
fos-GI/017	Curved

1-2 teeth

Code	Description
fos-GI/016a	Straight
fos-GI/017b	Curved

Kocher Artery Forceps

Box joint, 1-2 teeth

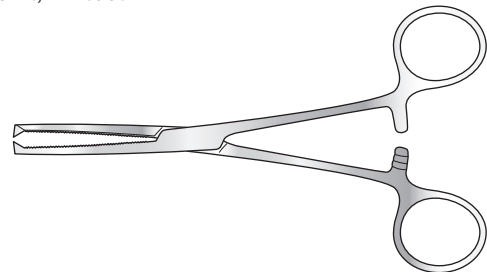

Straight

Code	Description
fos-GI/052	130mm long
fos-GI/053	150mm long
fos-GI/054	180mm long
fos-GI/055	200mm long
fos-GI/056	230mm long

Curved

Code	Description
fos-GI/057	150mm long
fos-GI/058	180mm long
fos-GI/059	200mm long
fos-GI/060	230mm long

Artery Forceps

Moynihan Artery Forceps

Box joint, half-serrated jaws

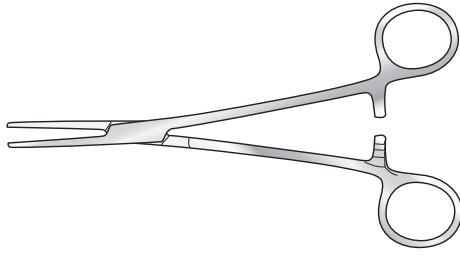

Straight

Code	Description
fos-GI/018	145mm long
fos-GI/068	180mm long

Curved

Code	Description
fos-GI/019	145mm long
fos-GI/069	180mm long

Rochester-Pean Artery Forceps

Box joint

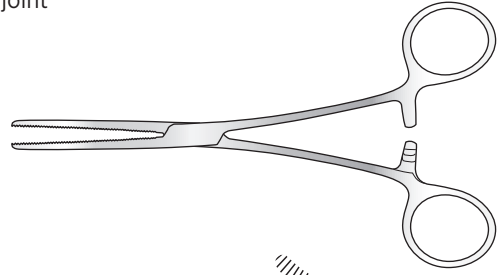

Straight

Code	Description
fos-GI/044	165mm long
fos-GI/045	190mm long
fos-GI/046	205mm long
fos-GI/047	240mm long

Curved

Code	Description
fos-GI/048	165mm long
fos-GI/049	180mm long
fos-GI/050	205mm long
fos-GI/051	240mm long

Roberts Artery Forceps

Screw joint, curved on flat, serrated

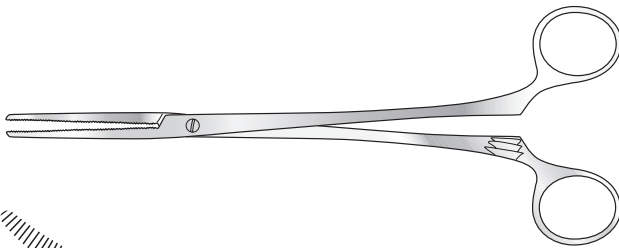

Code	Description
fos-GI/070	230mm long

Spencer Wells Artery Forceps

Box joint, serrated jaws

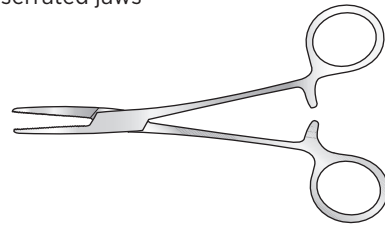

Straight

Code	Description
fos-GI/035	127mm long
fos-GI/036	152mm long
fos-GI/037	177mm long
fos-GI/038	203mm long

Curved

Code	Description
fos-GI/039	127mm long
fos-GI/040	152mm long
fos-GI/041	177mm long
fos-GI/042	203mm long

OTHER SIZES AVAILABLE

Dandy Artery Forceps

Box joint, curved in plane

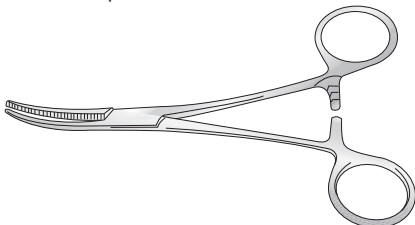

Code	Description
fos-GI/076	140mm long



Carmalt Angiotribe Forceps

Box joint, atraumatic, light pattern

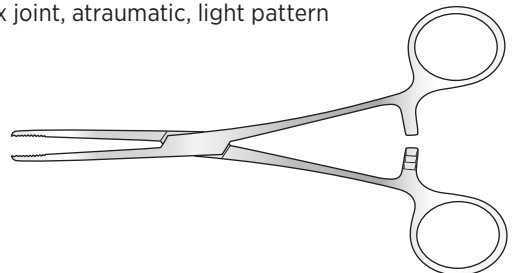

Straight

Code	Description
fos-GI/062	165mm long
fos-GI/063	200mm long
fos-GI/064	230mm long

Curved

Code	Description
fos-GI/061	165mm long

Dieffenbach Bulldog Clamp

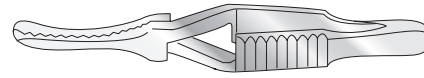
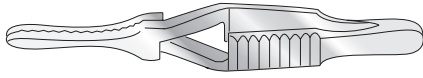

Straight, serrated

Code	Description
fos-GI/112	1.2mm fine jaw, 40mm long
fos-GI/113	1.2mm fine jaw, 45mm long
fos-GI/108	1.8mm jaw, 30mm long
fos-GI/109	1.8mm jaw, 35mm long
fos-GI/110	2.5mm jaw, 40mm long
fos-GI/111	2.5mm jaw, 45mm long
fos-GI/107	6mm heavy jaw, 60mm long
fos-GI/455	20mm jaw, 75mm long
fos-GI/455a	30mm jaw, 85mm long
fos-GI/455b	45mm jaw, 105mm long
fos-GI/455c	65mm jaw, 120mm long

Straight, plain

Code	Description
fos-GI/129	1.2mm fine jaw, 40mm long
fos-GI/131	1.2mm fine jaw, 45mm long
fos-GI/121	1.8mm jaw, 30mm long
fos-GI/123	1.8mm jaw, 35mm long
fos-GI/125	2.5mm jaw, 40mm long
fos-GI/127	2.5mm jaw, 45mm long

Curved, serrated

Code	Description
fos-GI/119	1.2mm fine jaw, 40mm long
fos-GI/120	1.2mm fine jaw, 45mm long
fos-GI/115	1.8mm jaw, 30mm long
fos-GI/116	1.8mm jaw, 35mm long
fos-GI/117	2.5mm jaw, 40mm long
fos-GI/118	2.5mm jaw, 45mm long
fos-GI/114	6mm heavy jaw, 60mm long
fos-GI/456	20mm jaw, 75mm long
fos-GI/456a	30mm jaw, 85mm long
fos-GI/456b	45mm jaw, 105mm long
fos-GI/456c	65mm jaw, 120mm long

Curved, plain

Code	Description
fos-GI/130	1.2mm fine jaw, 40mm long
fos-GI/132	1.2mm fine jaw, 45mm long
fos-GI/122	1.8mm jaw, 30mm long
fos-GI/124	1.8mm jaw, 35mm long
fos-GI/126	2.5mm jaw, 40mm long
fos-GI/128	2.5mm jaw, 45mm long

Blalock Bulldog Clamp

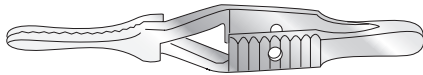

Serrated, with hole in handle

Straight

Code	Description
fos-GI/480	11mm jaw, 38mm long
fos-GI/482	14mm jaw, 48mm long
fos-GI/493	17mm jaw, 60mm long
fos-GI/481	27mm jaw, 70mm long

Curved

Code	Description
fos-GI/478	11mm jaw, 38mm long
fos-GI/479	14mm jaw, 48mm long
fos-GI/491	17mm jaw, 60mm long
fos-GI/492	27mm jaw, 70mm long

Plain, with hole in handle

Straight

Code	Description
fos-GI/486	11mm jaw, 38mm long
fos-GI/487	14mm jaw, 48mm long
fos-GI/488	17mm jaw, 60mm long
fos-GI/489	27mm jaw, 70mm long

Curved

Code	Description
fos-GI/483	11mm jaw, 38mm long
fos-GI/484	14mm jaw, 48mm long
fos-GI/485	17mm jaw, 60mm long
fos-GI/490	27mm jaw, 70mm long

Spring Forceps

Adsons Dissecting Forceps

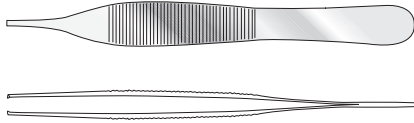

127mm long

Code	Description
fos-GI/257	1-2 teeth
fos-GI/258	Lightweight, micro
fos-GI/259	Serrated
fos-GI/260	Serrated, lightweight, micro

Block End Dissecting Forceps

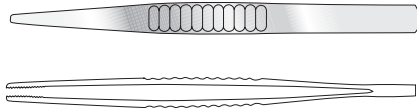

Serrated

Code	Description
fos-GI/255	127mm long
fos-GI/256	152mm long
fos-GI/256a	203mm long

Bonney Dissecting Forceps

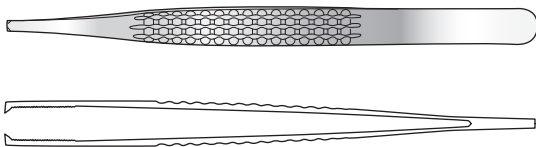

178mm long

Code	Description
fos-GI/267	Serrated, 1-2 teeth
fos-GI/268	1-2 teeth

Charnley-McIndoe Dissecting Forceps

150mm long

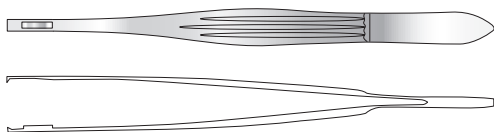

Code	Description
fos-OR/N045a	2-3 teeth

DeBakey Atraumatic Dissecting Forceps

Straight, atraumatic jaws

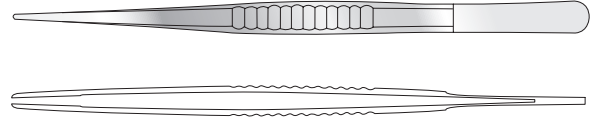
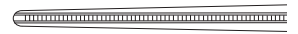

1.5mm

Code	Description
fos-GI/238a	150mm long
fos-GI/240a	240mm long

2.5mm

Code	Description
fos-GI/238b	150mm long
fos-GI/240b	240mm long

2mm

Code	Description
fos-GI/238	150mm long
fos-GI/241	180mm long

2.8mm

Code	Description
fos-GI/238c	150mm long
fos-GI/240c	240mm long
fos-GI/241c	180mm long

Dissecting Forceps

Turnover end, serrated jaws

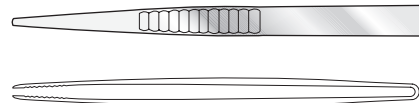

Code	Description
fos-GI/242	127mm long
fos-GI/243	152mm long

Code	Description
fos-GI/244	178mm long
fos-GI/245	203mm long

Dunhill Dissecting Forceps

Light, fine serrated jaws



Code	Description
fos-GI/457	145mm long

Fredrick Coole Dissecting Forceps

Extra fine serrated jaws

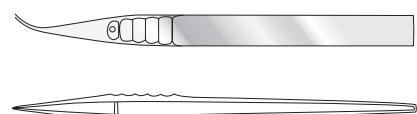

125mm long

Code	Description
fos-GI/066	Straight
fos-GI/067	Curved

Spring Forceps

Gillies Dissecting Forceps

1-2 teeth

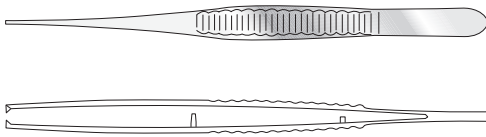

Code	Description
fos-PL/052	152mm long

McIndoe Dissecting Forceps

152mm long

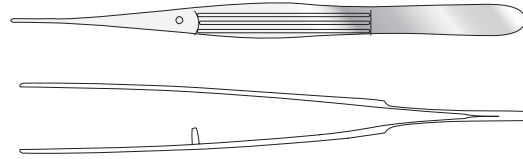

Code	Description
fos-GI/476	Serrated
fos-GI/477	1-2 teeth

Jackson Burrows Dissecting Forceps

140mm long

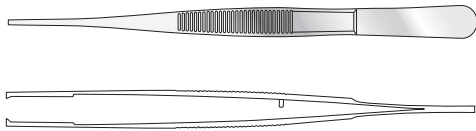

Code	Description
fos-OR/N037	Tongue and groove, 1-2 teeth
fos-OR/N037a	Tongue and groove only

McIndoe Modified Dissecting Forceps

152mm long, 1mm tip, modified for fine powerful dissection with strong action tip

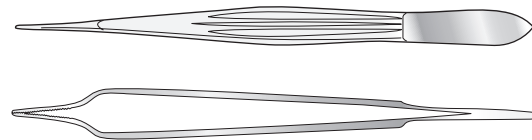

Code	Description
SH/5961	Serrated

Jean Dissecting Forceps

Serrated jaws, 140mm long

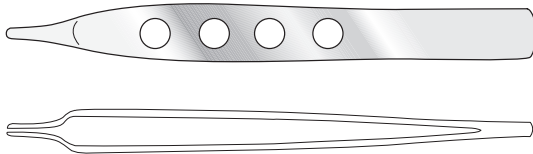

Code	Description
fos-GI/269	Fine
fos-GI/270	1-2 teeth
fos-GI/271	2-3 teeth, 178mm long

Treves Dissecting Forceps

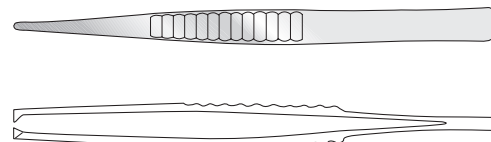

1-2 teeth

Code	Description
fos-GI/251	127mm long
fos-GI/252	152mm long

2-3 teeth

Code	Description
fos-GI/253	127mm long
fos-GI/254	152mm long

Lanes Dissecting Forceps

1-2 teeth on serrated jaws, 140mm long

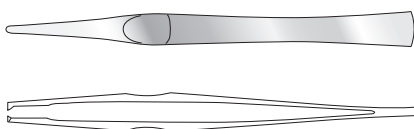

Code	Description
fos-GI/246	127mm long
fos-GI/247	152mm long
fos-GI/248	178mm long

Code	Description
fos-GI/249	2-3 teeth, 178mm long
fos-GI/250	2-3 teeth 203mm long

Waugh Dissecting Forceps

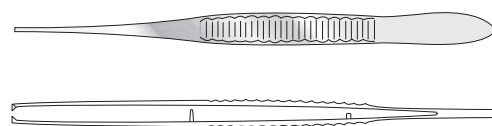

Fine, serrated

Code	Description
fos-GI/261	152mm long
fos-GI/262	178mm long
fos-GI/263	203mm long

Fine, 1-2 teeth

Code	Description
fos-GI/264	152mm long
fos-GI/265	178mm long
fos-GI/266	203mm long

Tissue Forceps

Allis Tissue Forceps

Box joint

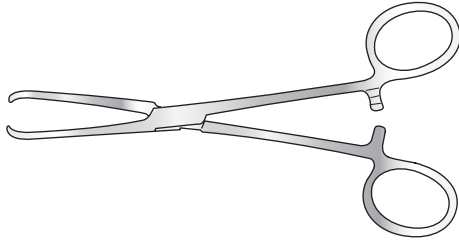

150mm long

Code	Description
fos-GI/272	3-4 teeth
fos-GI/273	4-5 teeth

190mm long

Code	Description
fos-GI/414	5-6 teeth

Duval Tissue Forceps

Box joint

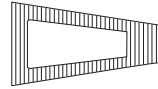
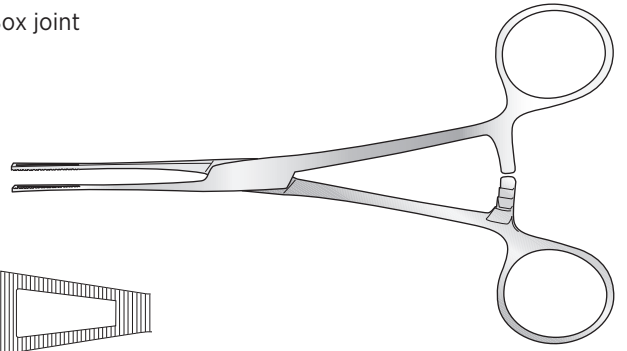

Code	Description
fos-GI/279	13mm wide, 203mm long

Littlewood Tissue Forceps

Box joint, 2-3 teeth

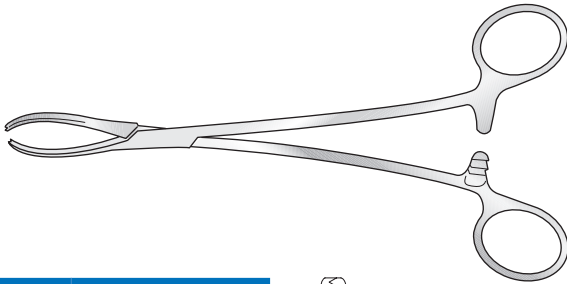

Code	Description
fos-GI/275	190mm long

Lane Tissue Forceps

Box joint, 1-2 teeth, fenestrated

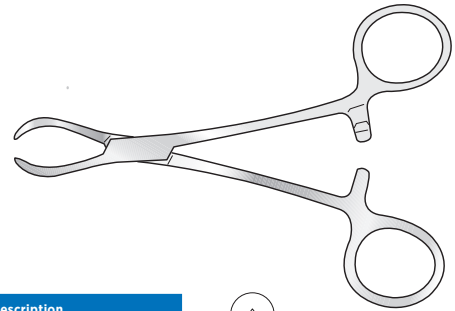

Code	Description
fos-GI/280	127mm long
fos-GI/281	152mm long
fos-GI/282	197mm long

Babcock Tissue Forceps

Box joint, serrated jaws

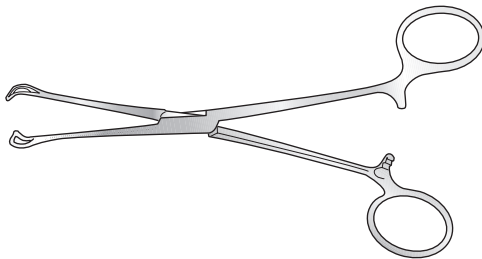

Code	Description
fos-GI/276	160mm long
fos-GI/277	200mm long
fos-GI/278	230mm long

Rutherford Morrison Tissue Forceps

Box joint

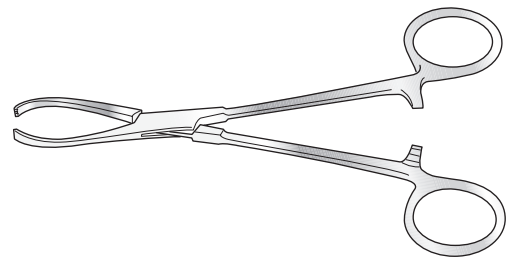

Code	Description
fos-GI/283	4-5 teeth, 152mm long

Shaw Tissue Forceps

Box joint

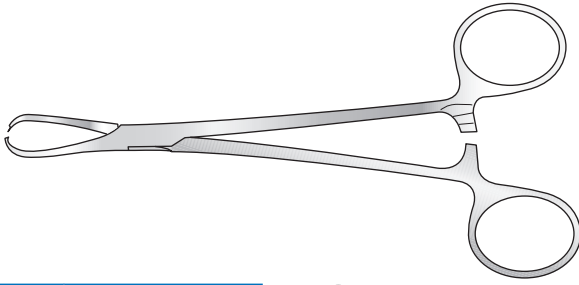

Code	Description
fos-GI/458	1-2 teeth, 178mm long



Guys Gallabin Suture-Holding Forceps

Screw joint, angled flat blades

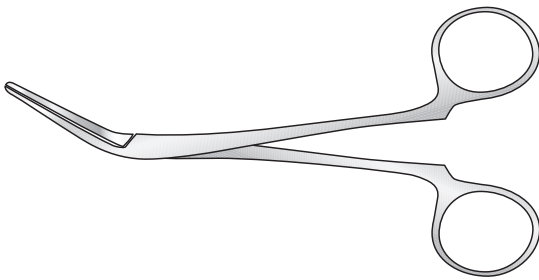

Code	Description
fos-GI/450	125mm long
fos-GI/4402	150mm long

Russian Dissecting Forceps

With fenestrated end

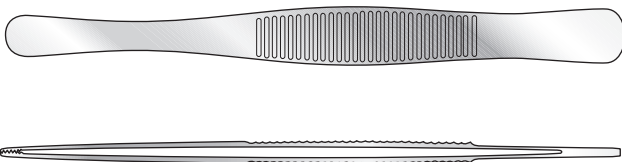

Code	Description
fos-GI/SH-5503b	150mm long
fos-GI/SH-5503	200mm long
fos-GI/403	230mm long
fos-GI/SH-5503a	250mm long



Sponge Holding and Sterilising Forceps

Rampley Sponge Holding Forceps

Box joint, straight, serrated jaws

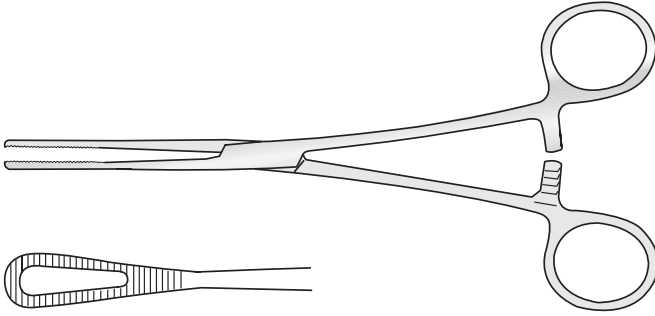

Code	Description
fos-GI/353	178mm long
fos-GI/354	241mm long

Lister Sinus Forceps

Box joint, serrated tip

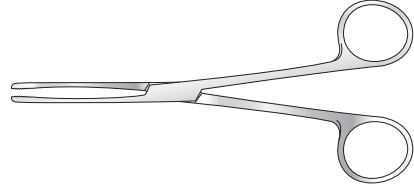

Code	Description
fos-GI/367	127mm long
fos-GI/368	152mm long
fos-GI/369	178mm long

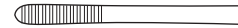

Foerster Sponge Holding Forceps

Box joint, straight, serrated jaws

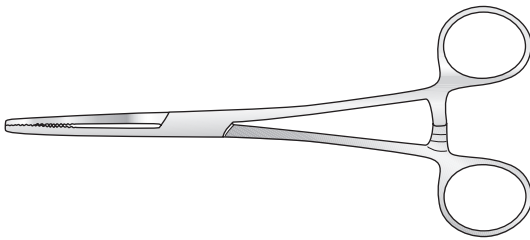

Code	Description
fos-GI/354a	178mm long

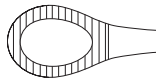

Cheatle Sterilizer Forceps

Screw joint

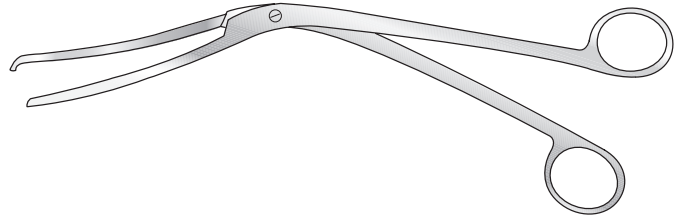

Code	Description
fos-GI/364	267mm long

Harrison Bowl Steriliser Forceps

Screw joint, angled, double jaw

Code	Description
fos-GI/365	356mm long
fos-GI/366	457mm long

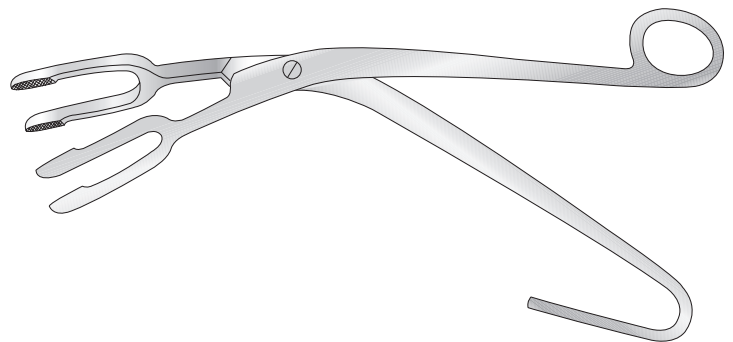

Other Forceps

Hunter Splinter Forceps

Serrated grooved pointed jaws



Code	Description
fos-GI/360	115mm long

Michel Forceps

Box joint, double-ended, for inserting and removing clips stainless steel

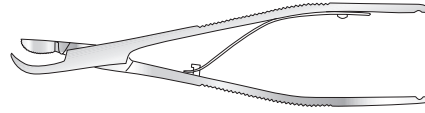

Code	Description
fos-GI/357	130mm long

Michel Skin Holding Forceps

With magazine for Michel clips

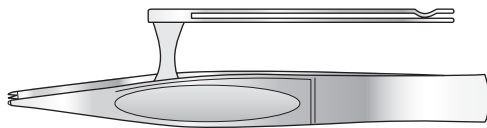

Code	Description
fos-GI/358	1-2 teeth, 127mm long

Michel Clip Extracting Forceps

Box joint

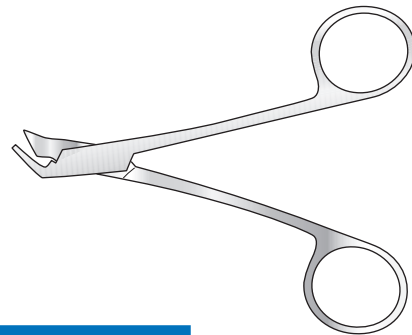

Code	Description
fos-GI/359	125mm long

Childe Approximating Forceps

With magazine for Michel clips

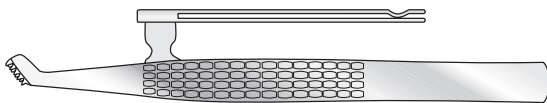

Code	Description
fos-GI/469	180mm long

Robins Anchoring Forceps

140mm long

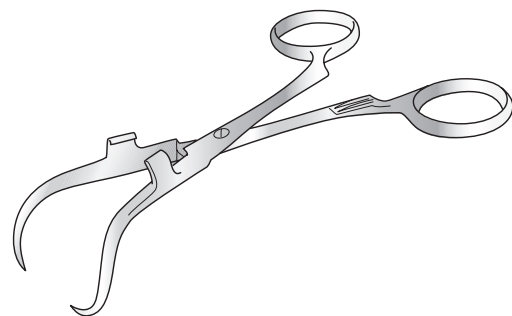

Code	Description
fos-GI/453	5mm with holder for diathermy leads
fos-GI/453a	13mm with holder for suction tubing

Premium Quality Stainless Steel Scissors

Dressing Scissors

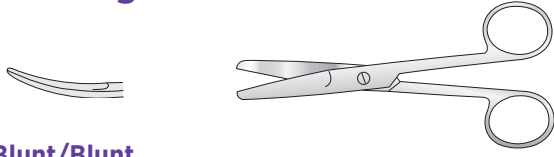

Blunt/Blunt

Straight

Code	Description
fos-GI/133	130mm long
fos-GI/136	146mm long
fos-GI/139	165mm long

Curved

Code	Description
fos-GI/142	130mm long
fos-GI/143	146mm long
fos-GI/144	165mm long
fos-GI/145	185mm long
fos-GI/404	147mm long

With one serrated blade

Blunt/Sharp

Straight

Code	Description
fos-GI/134	130mm long
fos-GI/137	146mm long
fos-GI/140	165mm long

Sharp/Sharp

Straight

Code	Description
fos-GI/135	130mm long
fos-GI/138	146mm long
fos-GI/141	165mm long

Curved

Code	Description
fos-GI/146	130mm long

Dressing Scissors, Left-Handed

With one black bow, 145mm long

Blunt/Blunt

Code	Description
fos-GI/192	Straight
fos-GI/193	Curved

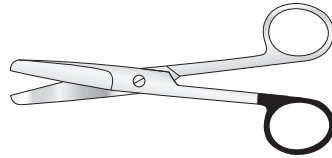

Blunt/Sharp

Code	Description
fos-GI/194	Straight
fos-GI/195	Curved

Sharp/Sharp

Code	Description
fos-GI/196	Straight
fos-GI/197	Curved

Littler Dissecting Scissors

Fine pattern, with eye for suture

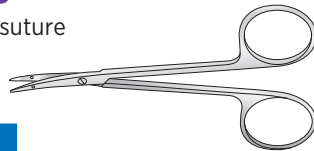

Code	Description
fos-PL/001f	115mm long

Kilner Dissecting Scissors

Fine pattern



Code	Description
fos-PL/001a	115mm long

Metzenbaum Scissors

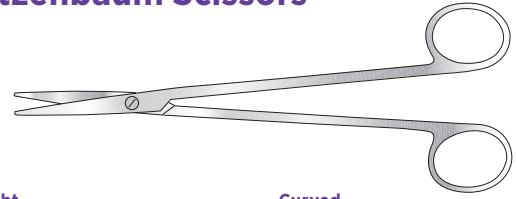

Straight

Code	Description
fos-GI/405	180mm long
fos-GI/406	147mm long
fos-GI/406a	200mm long
fos-GI/406b	230mm long
fos-GI/406c	250mm long
fos-GI/406d	280mm long

Curved

Code	Description
fos-GI/407	185mm long
fos-GI/408	147mm long
fos-GI/408a	200mm long
fos-GI/408b	230mm long
fos-GI/408c	250mm long
fos-GI/408d	280mm long

Mayo Scissors



Straight

Code	Description
fos-GI/409	140mm long
fos-GI/409a	160mm long
fos-GI/411	190mm long
fos-GI/411a	230mm long

Curved

Code	Description
fos-GI/410	140mm long
fos-GI/410a	160mm long
fos-GI/412	190mm long
fos-GI/412a	230mm long

Fergusson Scissors

Angled on flat

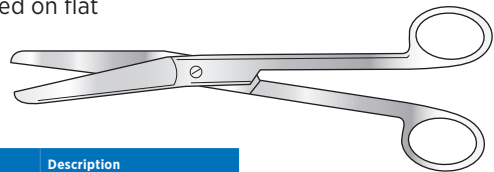

Code	Description
fos-GI/148	180mm long

Paynes Suture Scissors

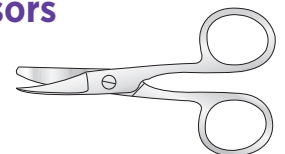

Code	Description
fos-GI/152	100mm long

Ligature Stitch Scissors

Fine pattern

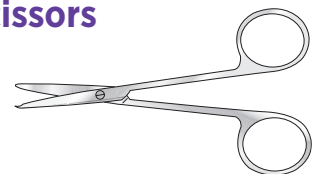

Code	Description
fos-GI/153	115mm long

Lister Bandage Scissors

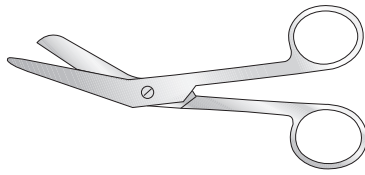

Code	Description
fos-GI/154	147mm long
fos-GI/155	178mm long

Lister Bandage Scissors

Angled, with probe end

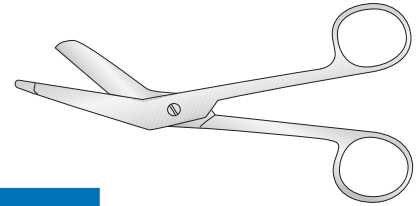

Code	Description
fos-GI/361	147mm long
fos-GI/362	178mm long

McIndoe Scissors

178mm long

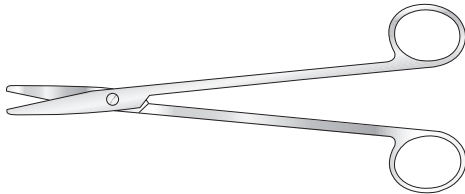

Code	Description
fos-GI/149	Straight
fos-GI/150	Curved on flat
fos-GI/150sc	Supercut, curved



Thomas Strabismus Scissors

114mm long

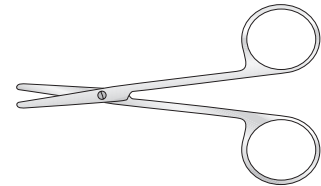

Code	Description
fos-OP/030	Straight
fos-OP/029	Curved

Heath Stitch Scissors

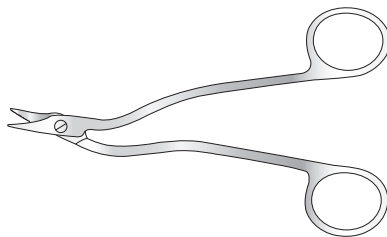

Code	Description
fos-GI/151	152mm long

“Careless” Scissors

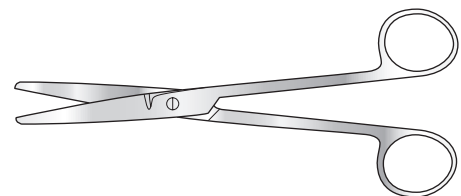

Code	Description
fos-GI/474	165mm long

Tubing Scissors

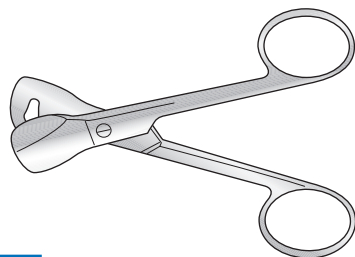

Code	Description
fos-GI/147	130mm long

Utility Scissors



Code	Description
fos-GI/466	190mm long

Tungsten Carbide Hard Insert Scissors

Dressing Scissors

Tungsten carbide hard insert, blunt/blunt

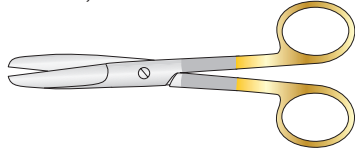

Straight

Code	Description
fos-GI/430	130mm long
fos-GI/432	145mm long
fos-GI/434	165mm long
fos-GI/436	185mm long

Curved

Code	Description
fos-GI/431	130mm long
fos-GI/433	145mm long
fos-GI/435	165mm long

Mayo Dressing Scissors

Tungsten carbide hard insert

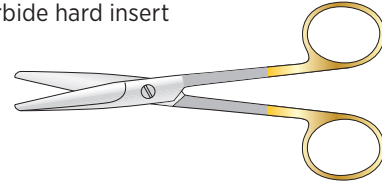

Straight

Code	Description
fos-GI/419	140mm long
fos-GI/419a	160mm long
fos-GI/421	190mm long
fos-GI/421a	230mm long

Curved

Code	Description
fos-GI/420	140mm long
fos-GI/420a	160mm long
fos-GI/422	190mm long
fos-GI/422a	230mm long

Dressing Scissors

Tungsten carbide hard insert, blunt/sharp

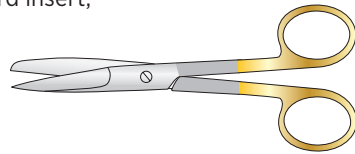

Straight

Code	Description
fos-GI/423	130mm long
fos-GI/425	145mm long
fos-GI/427	165mm long
fos-GI/429	185mm long

Curved

Code	Description
fos-GI/424	130mm long
fos-GI/426	145mm long
fos-GI/428	165mm long

Mayo-Harrington Dressing Scissors

Tungsten carbide hard insert

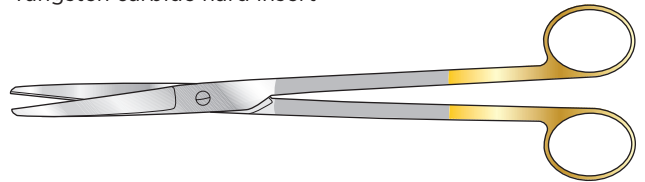

230mm long

Code	Description
fos-GI/417	Straight
fos-GI/418	Curved

200mm long

Code	Description
fos-GI/162a	Straight
fos-GI/413b	Curved

Dressing Scissors

Tungsten carbide hard insert sharp/sharp

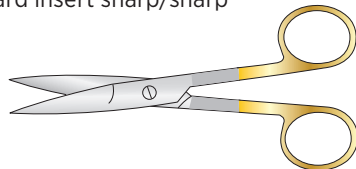

Straight

Code	Description
fos-GI/437	130mm long
fos-GI/439	145mm long
fos-GI/441	165mm long
fos-GI/443	185mm long

Curved

Code	Description
fos-GI/438	130mm long
fos-GI/440	145mm long
fos-GI/442	165mm long

Metzenbaum Scissors

Tungsten carbide hard insert

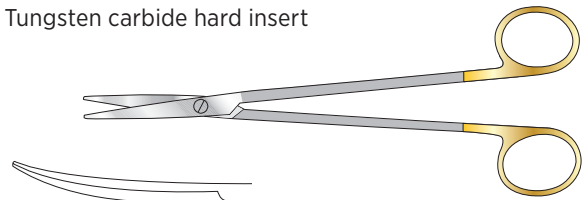

230mm long

Code	Description
fos-GI/445	145mm long
fos-GI/448	185mm long
fos-GI/471a	230mm long
fos-GI/471b	250mm long
fos-GI/471c	280mm long

200mm long

Code	Description
fos-GI/446	145mm long
fos-GI/449	185mm long
fos-GI/449a	200mm long
fos-GI/449b	230mm long
fos-GI/449c	250mm long
fos-GI/449d	280mm long

Baby Metzenbaum Scissors

Tungsten carbide, hard insert, 145mm long

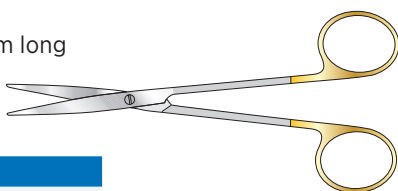

Code	Description
fos-GI/445a	Straight
fos-GI/446a	Curved

Ligature Scissors

Tungsten carbide hard insert, curved

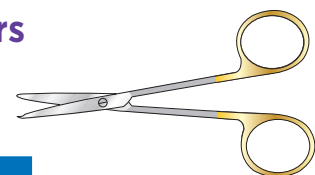

Code	Description
fos-GI/444	145mm long
fos-GI/447	185mm long

Tungsten Carbide Supercut Scissors

Mayo Harrington Scissors

Supercut, tungsten carbide

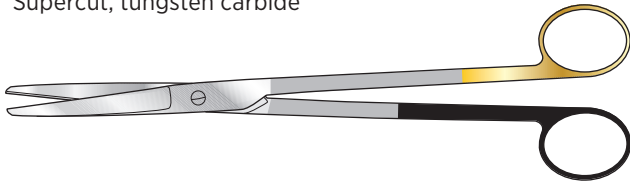

230mm long

Code	Description
fos-GI/162	Straight
fos-GI/413	Curved

200mm long

Code	Description
fos-GI/162b	Straight
fos-GI/413b	Curved

Dressing Scissors

Supercut, tungsten carbide

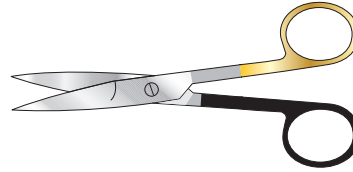

Blunt/Blunt

Straight

Code	Description
fos-GI/174	130mm long
fos-GI/176	145mm long
fos-GI/178	165mm long
fos-GI/180	185mm long

Curved

Code	Description
fos-GI/175	130mm long
fos-GI/177	145mm long
fos-GI/179	165mm long
fos-GI/180a	185mm long

Mayo Scissors

Supercut, tungsten carbide

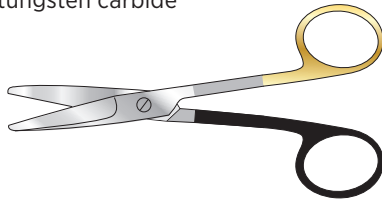

Straight

Code	Description
fos-GI/163	140mm long
fos-GI/163a	160mm long
fos-GI/165	190mm long
fos-GI/165a	230mm long

Curved

Code	Description
fos-GI/164	140mm long
fos-GI/164a	160mm long
fos-GI/166	190mm long
fos-GI/166a	230mm long

Blunt/Sharp

Straight

Code	Description
fos-GI/167	130mm long
fos-GI/169	145mm long
fos-GI/171	165mm long
fos-GI/173	185mm long

Curved

Code	Description
fos-GI/168	130mm long
fos-GI/170	145mm long
fos-GI/172	165mm long
fos-GI/173a	185mm long

Sharp/Sharp

Straight

Code	Description
fos-GI/181	130mm long
fos-GI/183	145mm long
fos-GI/185	165mm long
fos-GI/187	185mm long

Curved

Code	Description
fos-GI/182	130mm long
fos-GI/184	145mm long
fos-GI/186	165mm long
fos-GI/187a	185mm long

Metzenbaum Dissecting Scissors

Supercut, tungsten carbide

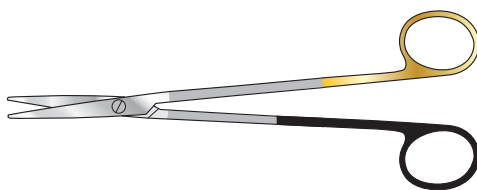

Straight

Code	Description
fos-GI/188tc	185mm long
fos-GI/188tca	200mm long
fos-GI/188tcb	230mm long
fos-GI/188tcc	250mm long
fos-GI/188tcd	280mm long

Curved

Code	Description
fos-GI/191tc	147mm
fos-GI/189tc	185mm
fos-GI/186tca	200mm
fos-GI/188tcb	230mm
fos-GI/188tcc	250mm
fos-GI/188tcd	280mm

Supercut Operating Scissors

Dressing Scissors

Supercut, blunt/blunt

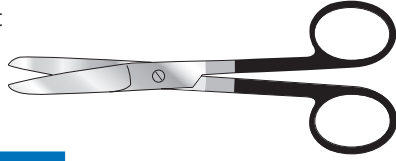

145mm long

Code	Description
fos-GI/160	Straight
fos-GI/161	Curved

Dressing Scissors

Supercut, blunt/sharp



145mm long

Code	Description
fos-GI/156	Straight
fos-GI/157	Curved

Dressing Scissors

Supercut, sharp/sharp



145mm long

Code	Description
fos-GI/158	Straight
fos-GI/159	Curved

Mayo Scissors

Supercut

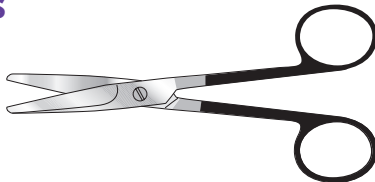

Straight

Code	Description
fos-GI/166a	140mm long
fos-GI/166e	160mm long
fos-GI/166b	170mm long

Curved

Code	Description
fos-GI/166c	140mm long
fos-GI/166f	160mm long
fos-GI/166d	170mm long

Boyd Scissors

Supercut, blunt/blunt

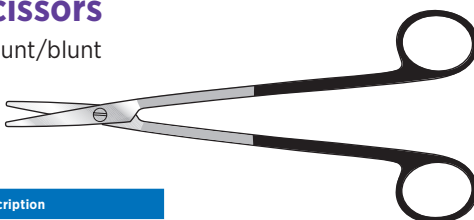

Code	Description
fos-THO/047	180mm long

Metzenbaum Dissecting Scissors

Supercut

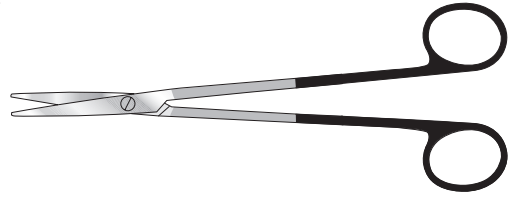

Straight (length)

Code	Description
fos-GI/190	147mm
fos-GI/188	185mm
fos-GI/188a	200mm
fos-GI/188b	230mm
fos-GI/188c	250mm
fos-GI/188d	280mm

Curved (length)

Code	Description
fos-GI/191	147mm
fos-GI/189	185mm
fos-GI/186a	200mm
fos-GI/186b	230mm
fos-GI/186c	250mm
fos-GI/186d	280mm

Stevens Tenotomy Scissors

Supercut



Curved/blunt

Code	Description
fos-OP/424	114mm long
fos-OP/424a	125mm long
fos-OP/424gb	135mm long

Curved/sharp

Code	Description
fos-OP/425	114mm long
fos-OP/425a	140mm long
fos-OP/425b	160mm long

With cutout, 110mm long

Code	Description
fos-OP/426	Straight/blunt, 114mm long
fos-OP/427	Straight/sharp, 114mm long
fos-OP/427c	Straight/sharp, 180mm long

With cutout, 110mm long

Code	Description
fos-OP/427a	Straight/blunt
fos-OP/427b	Curved/blunt

Strabismus Scissors

Supercut



114mm long

Code	Description
fos-GI/475	Straight
fos-GI/475a	Curved

Iris Scissors

Supercut

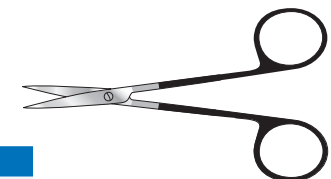

114mm long

Code	Description
fos-OP/476	Straight
fos-OP/476a	Curved

Bruce Clarke Needle Holder

Screw joint

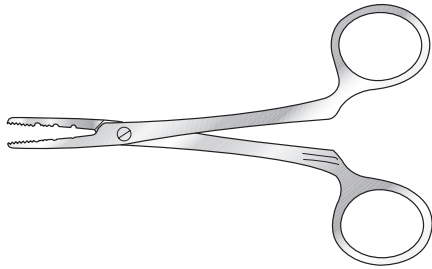

Code	Description
fos-GI/205	127mm long

Lawrence Needle Holder

Fine jaw, 150mm long

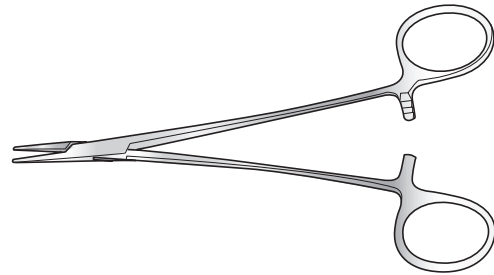

Code	Description
fos-PL/012a	
fos-PL/012b	Tungsten carbide jaw

Crile-Wood Needle Holder

Straight, baby, fine

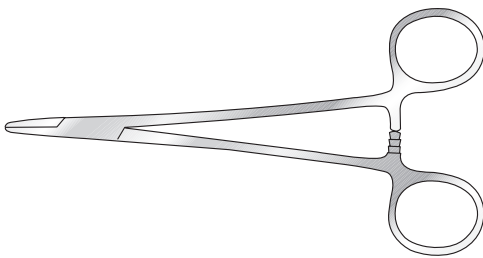

Code	Description
fos-GI/199	150mm long

Needle Holder

Future Oriented pattern, box joint, lightweight, with curved plain jaws and one offset bow for thumb

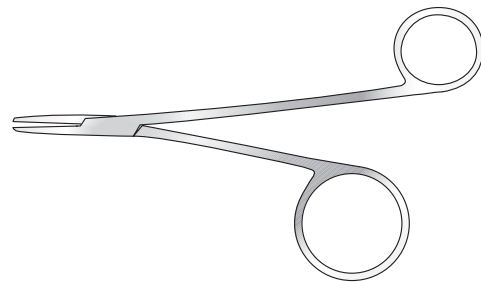

Code	Description
fos-GI/209	152mm long

Kilner Needle Holder

Box joint, cross-serrated jaw

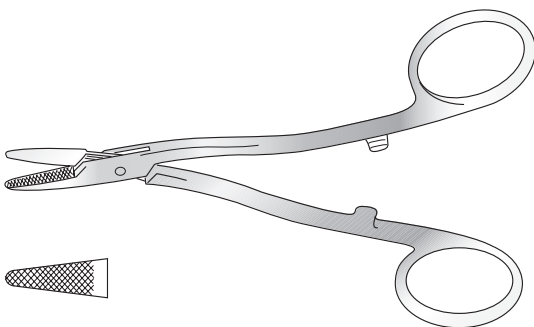

Code	Description
fos-GI/200	165mm long
fos-GI/201	133mm long

MacPhail Needle Holder

Screw joint, with one copper jaw

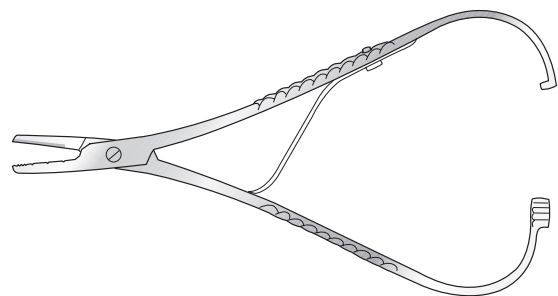

Code	Description
fos-GI/206	159mm long
fos-GI/207	178mm long
fos-GI/208	209mm long

Needle Holders

Mathieu Needle Holder

Screw joint

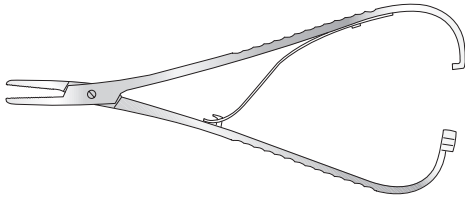

Code	Description
fos-GI/210	172mm long
fos-GI/211	209mm long
fos-GI/212	243mm long

Naughton Morgan Needle Holder

Box joints, cross serrated jaws

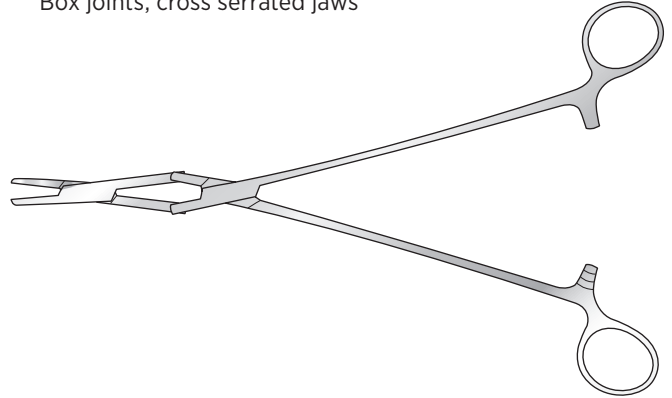

Mayo Needle Holder

Box joint, straight

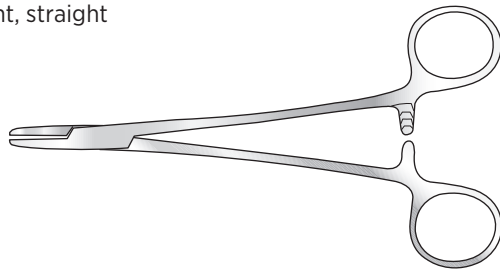

Wide cross serrated jaws

Code	Description
fos-GI/224	159mm long
fos-GI/398	203mm long

Narrow cross serrated jaws

Code	Description
fos-GI/225	159mm long

Tungsten carbide

Code	Description
fos-GI/399	185mm long
fos-GI/400	254mm long

Code	Description
fos-GI/401	185mm long
fos-GI/402	254mm long

Rochester-Mayo Needle Holder

Screw joint

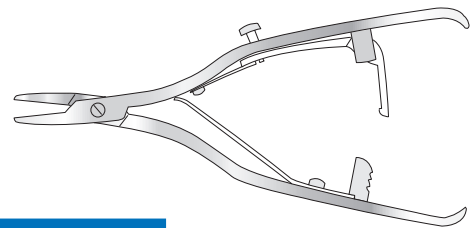

Code	Description
fos-GI/213	178mm long

Tungsten Carbide Needle Holders

Berry Needle Holder/Wire Twister

Tungsten carbide jaws

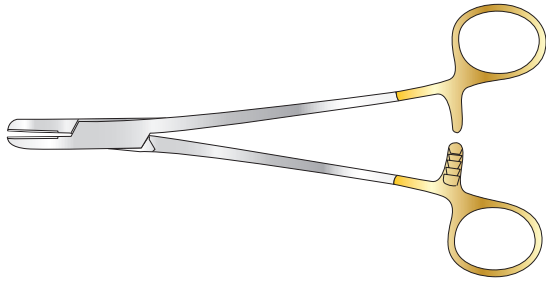

Code	Description
fos-GI/467	200mm long

Finochietto Needle Holder

Tungsten carbide jaws

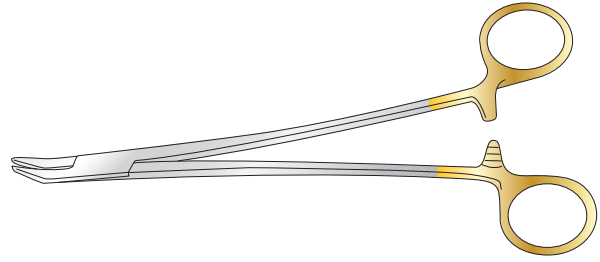

Code	Description
fos-GI/222	215mm long
fos-GI/223	265mm long

Crile-Wood Needle Holder

Tungsten carbide insert, box joint, satin finish, straight

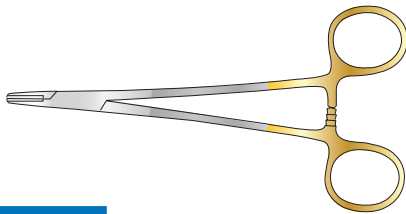

Code	Description
fos-GI/217	159mm long
fos-GI/218	178mm long
fos-GI/198	150mm long

Halsey Needle Holder

Tungsten carbide insert, box joint, satin finish, straight

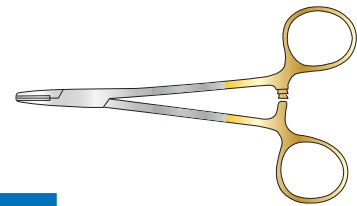

Code	Description
fos-GI/220	127mm long

Derf Needle Holder

Tungsten carbide insert



Code	Description
fos-GI/BUPHF002	115mm long

Kilner Needle Holder

Tungsten carbide insert

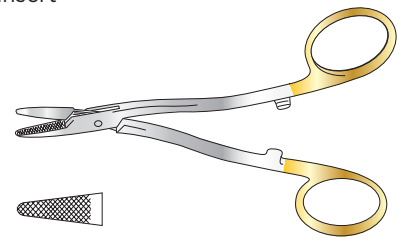

Code	Description
fos-GI/221	140mm long

Tungsten Carbide Needle Holders

Masing Needle Holder

Tungsten carbide insert, one angled bow

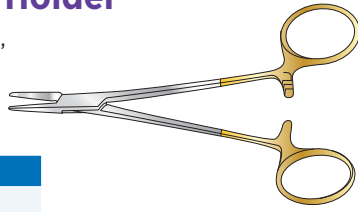

Code	Description
fos-GI/009R	130mm long

Nievert Needle Holder

Tungsten carbide insert, box joint, satin finish, straight

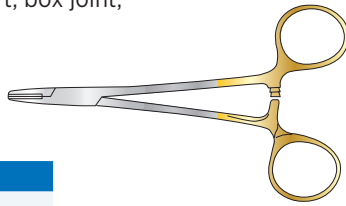

Code	Description
fos-GI/219	127mm long

DeBakey Needle Holder

250mm long

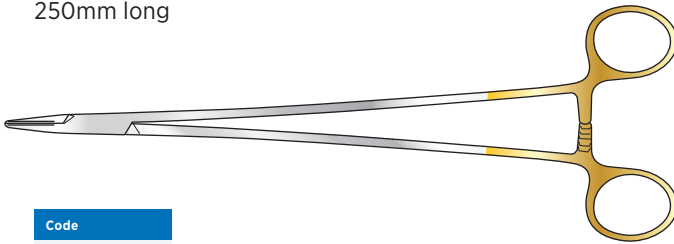

Code
THO/fos-5642a

Ryder Needle Holder

Tungsten carbide insert, box joint, satin finish, straight

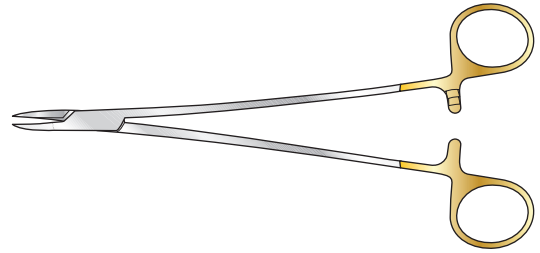

0.2mm jaw pitch

Code	Description
fos-GI/SH-5197a	135mm long
fos-GI/SH-5197b	155mm long
fos-GI/SH-5197c	175mm long
fos-GI/SH-5197d	210mm long

0.4mm jaw pitch

Code	Description
fos-GI/SH-5198a	135mm long
fos-GI/SH-5198b	155mm long
fos-GI/SH-5198c	175mm long
fos-GI/SH-5198d	210mm long

Sarot Needle Holder

Diamond jaw, tungsten carbide, gold plated bows

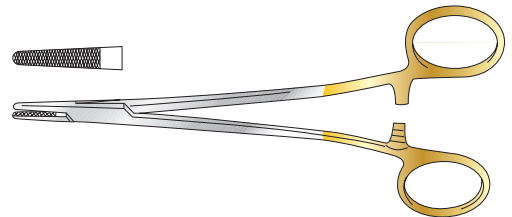

Code	Description
fos-GI/451	181mm long

Mayo-Hegar Needle Holder

Tungsten carbide insert, box joint, satin finish, straight

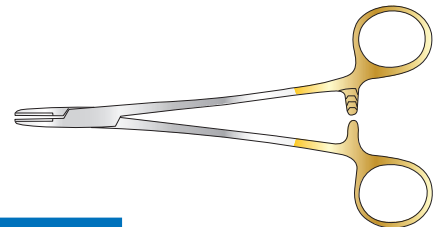

Code	Description
fos-GI/472	130mm long
fos-GI/214	159mm long
fos-GI/215	178mm long
fos-GI/216	209mm long

LONGER SIZES AVAILABLE

Tungsten Carbide Needle Holders

Features and Benefits

- Jaw**
Tungsten carbide inserts bonded into the jaws for a long lasting, secure grip
- Bevelled Edges**
Prevents suture from snagging
- Laser Etching**
Date and catalogue number are etched for easy re-ordering. Laser etch will not harm instrument like traditional methods
- Satin Finish**
Reduces glare
- Ratchets**
Precisely cut for effortless locking/unlocking
- Teeth**
Fine, hard teeth, diamond cut into an insert of hardened tungsten carbide for superior needle grasping and suture tying capabilities
- Vacuum Brazing**
Combines bonding of the tungsten carbide insert with the simultaneous vacuum hardening of the instrument for greater durability and longevity
- Shanks**
Precision balanced for comfort and control
- Gold Handles**
For easy identification

Combined Scissor and Needle Holders

Olsen-Hegar Scissor/Needle Holder

With tungsten carbide insert

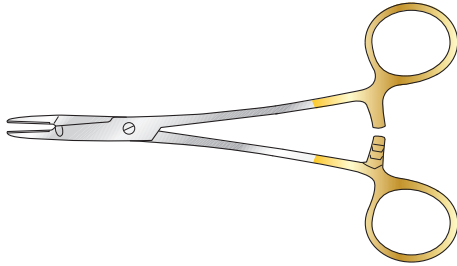

Code	Description
fos-GI/229	147mm long
fos-GI/230	165mm long

Olsen-Hegar Scissor/Needle Holder

Screw joint

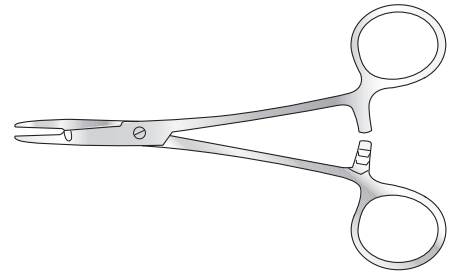

Code	Description
fos-GI/226	140mm long
fos-GI/227	165mm long
fos-GI/228	190mm long

Gillies Scissor/Needle Holder

Right-hand, with tungsten carbide insert

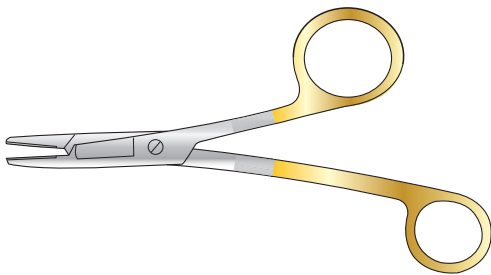

Code	Description
fos-GI/235	158mm long

Gillies Scissor/Needle Holder

Heavy pattern, 158mm long



Code	Description
fos-GI/233	Right-hand
fos-GI/234	Left-hand

Gillies Scissor/Needle Holder

158mm long

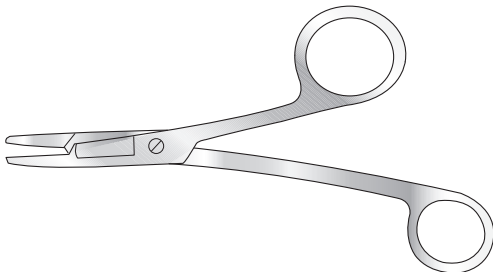

Code	Description
fos-GI/231	Right-hand
fos-GI/232	Left-hand

Foster Gillies Scissor/Needle Holder

Fine pattern

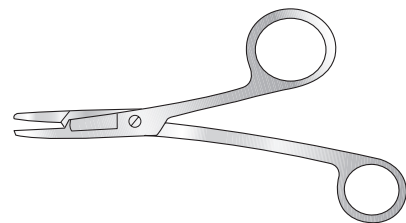

Code	Description
fos-GI/236	127mm long

Bag and Towel Clips

Spring Clip

Serrated pattern, stainless steel, for fixing slings to leg splints, also for towel clipping

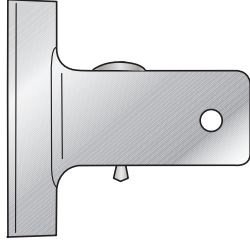

Code	Description
fos-GI/344	63mm wide

Spring Bag Clip

Serrated

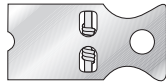

Code	Description
fos-GI/345	26mm wide

Jones Towel Clip

Superior quality spring forcep type

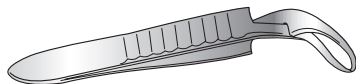

Code	Description
fos-GI/346	89mm long

Shardles Towel Clip

Spring curved, cross action

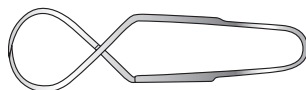

Code	Description
fos-GI/347	77mm long

Backhaus Towel Clip

Superior quality, box joint

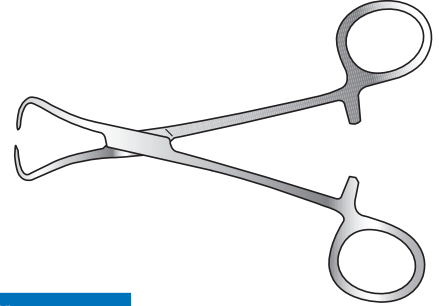

Code	Description
fos-GI/348	89mm long
fos-GI/348a	102mm long
fos-GI/349	130mm long

Moynihan Towel Clip

Screw joint, 2-2 teeth, for sides of incision

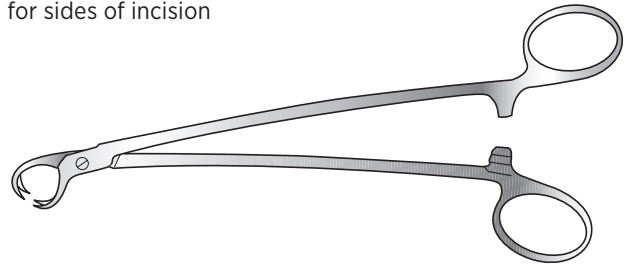

Code	Description
fos-GI/470	191mm long

Ball and Socket Towel Forceps

Box joint

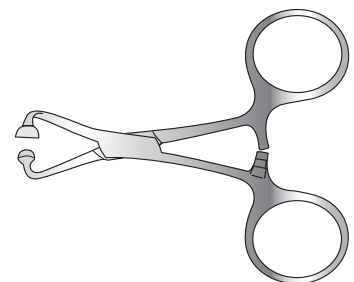

Code	Description
fos-GI/350	89mm long
fos-GI/351	115mm long
fos-GI/352	140mm long

Retractors

Goligher Retractor

Complete with 2 centre blades:
 1 x 90mm wide x 50mm deep
 1 x 90mm wide x 90mm deep

and 2 pairs of lateral blades:
 1 pair 25mm wide x 45mm deep
 1 pair 50mm wide x 90mm deep

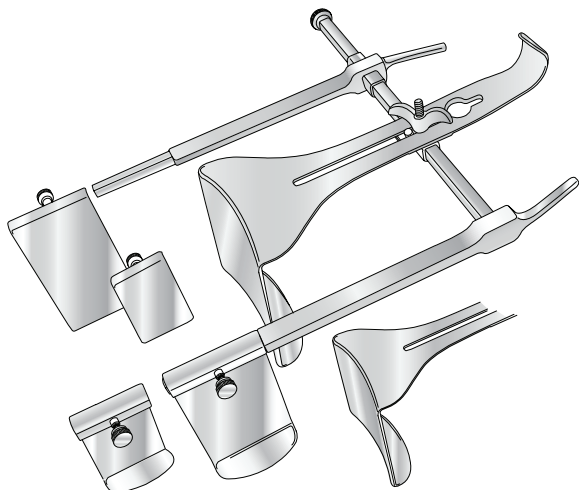

Code
 fos-GI/305

Balfour Abdominal Retractor

Trivalve, frame 203mm

Child

102mm opening, 51mm deep lateral blades,
 38mm deep centre blade

Adult

178mm opening, 64mm deep lateral blades,
 44mm deep centre blade

Extra large

178mm opening, 102mm deep lateral blades,
 108mm deep centre blade

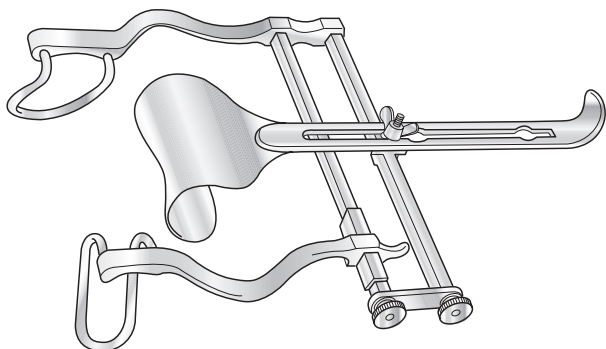

Code	Description
fos-GI/373	Child
fos-GI/374	Adult
fos-GI/375	Extra large

Miles Retractor

Complete with 2 centre blades:
 1 x 90mm wide x 50mm deep
 1 x 90mm wide x 75mm deep

and 2 pairs of lateral blades:
 1 pair 80mm wide x 35mm deep
 1 pair 80mm wide x 75mm deep

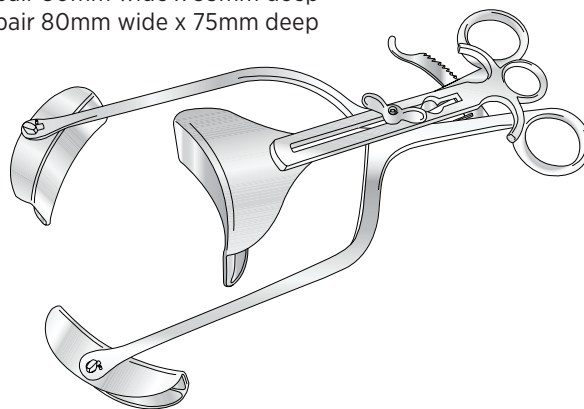

Code	Description
fos-GI/376	340mm long

OTHER BLADE SIZES AVAILABLE

Balfour Abdominal Retractor

Bivalve, baby

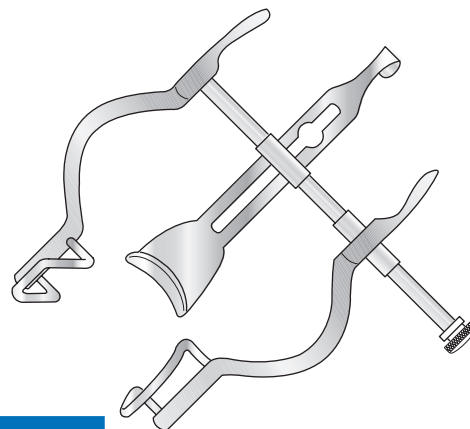

Code	Description
fos-GI/372	Fully open 89mm

Berkeley Abdominal Retractor

Parallel action

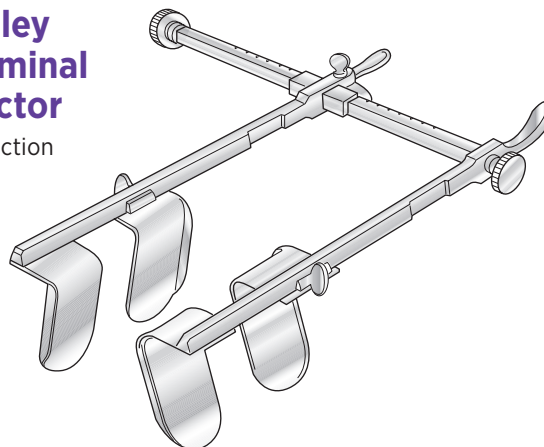

Code	Description
fos-GI/461	Blades 35mm x 60mm deep, 215mm long

Turner Warwick Retractors

Turner Warwick Universal Self Retaining Retractor

Code	Description
fos-GI/520	With frames A/B/C/D and blades A/B/C/D/E/F/K/L
fos-GI/521-A	Circular frame A only 178mm
fos-GI/521-B	Circular frame B only 229mm
fos-GI/521-C	Circular frame C only 305mm
fos-GI/521-D	Oval frame D only 475mm x 330mm
fos-GI/521-E	Oval frame E only 370mm x 300mm

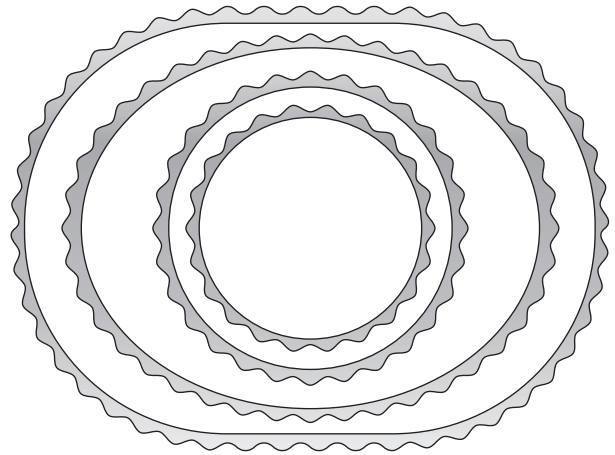

Turner Warwick Needleholder with Tungsten Carbide Jaws

Curved shanks with one short bow

Code	Description
SH-5835	230mm long
SH-5835A	200mm long

Blade A



Code	Description
fos-GI/522-A	Blade only - 19mm x 76mm

Blade B

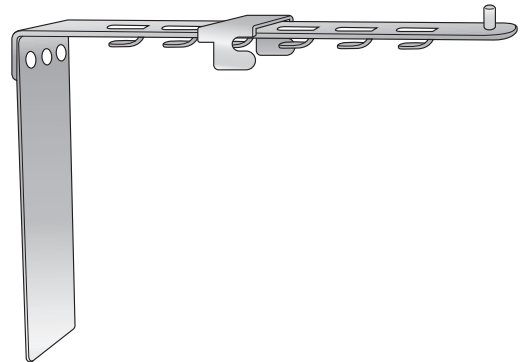

Code	Description
fos-GI/522-B	Blade only - 38mm x 102mm

Blade C

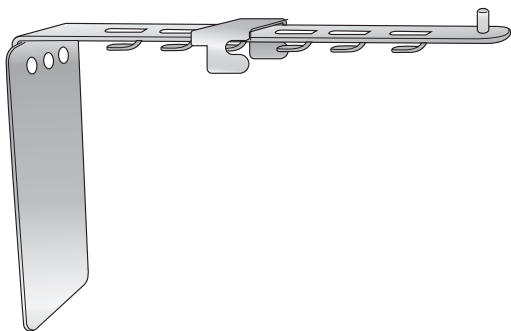

Code	Description
fos-GI/522-C	Blade only - 57mm x 89mm

Blade D

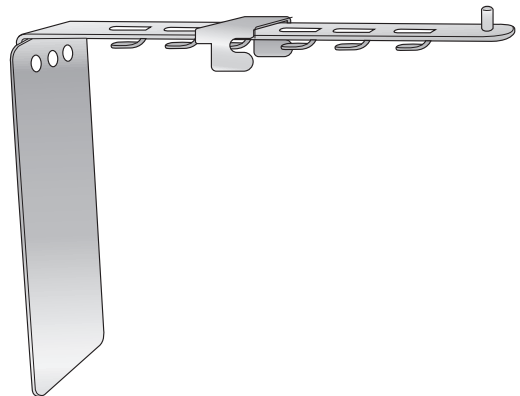

Code	Description
fos-GI/522-D	Blade only - 57mm x 114mm

Blade E

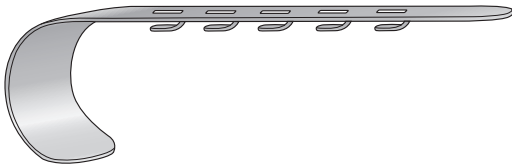

Code	Description
fos-GI/522-E	Blade only - curved stainless steel blade 51mm x 38mm

Blade F

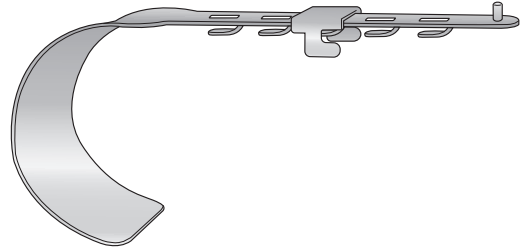

Code	Description
fos-GI/522-F	Blade only - curved stainless steel blade 76mm x 60mm

Blade G

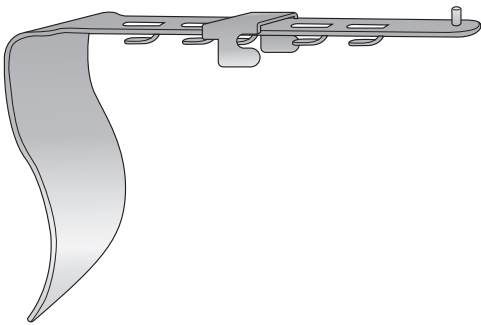

Code	Description
fos-GI/522-G	Blade only - flat stainless steel blade 89mm x 60mm

Blade J

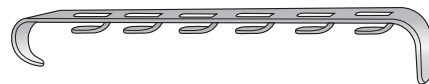

Code	Description
fos-GI/522-J	Blade only - single hook, 13mm deep

Blade K

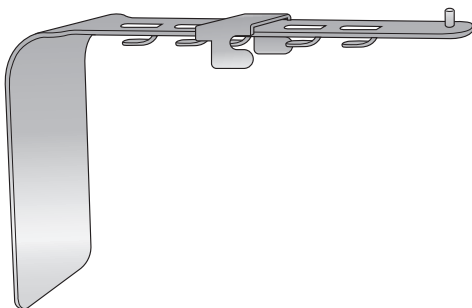

Code	Description
fos-GI/522-K	Blade only - flat with clip 55mm x 90mm

Blade L

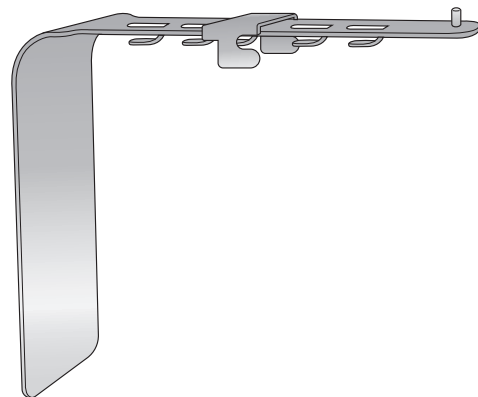

Code	Description
fos-GI/522-L	Blade only - flat with clip 55mm x 120mm

Retractors

Collin Retractor

110mm fully open, 235mm long

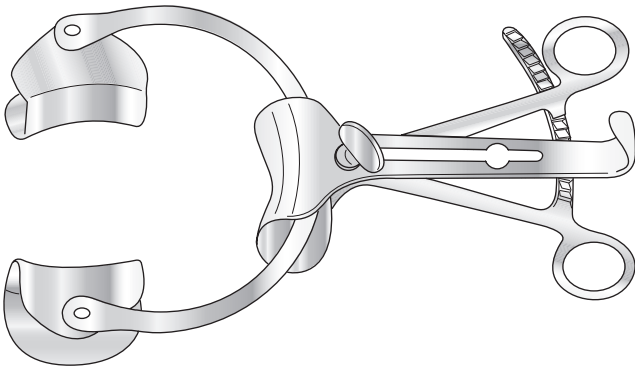

Code	Description
fos-GI/322	Complete with centre blade 55 x 40mm and one pair of blades 38mm x 60mm
fos-GI/322a	Without centre blade

Gelpi Retractor

Self retaining

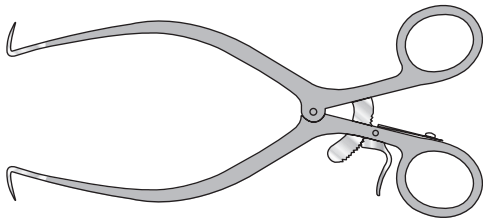

Code	Description
fos-GY/013a	140mm long
fos-GY/013b	178mm long

Joll Thyroid Retractor

Self retaining, with lock-in nut

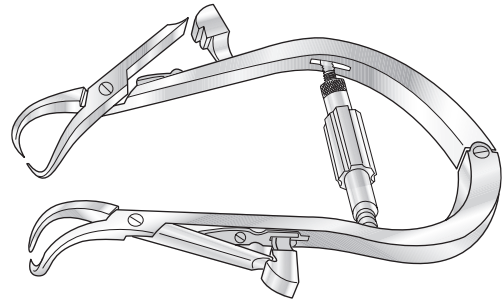

Code	Description
fos-GI/363	152mm long

Gossett Abdominal Retractor

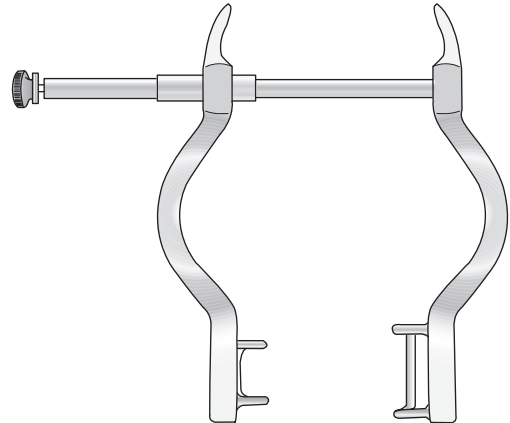

Code	Description
fos-GI/303	Large, fully open 185mm long
fos-GI/304	Small, fully open 95mm long

Pozzi Abdominal Retractors

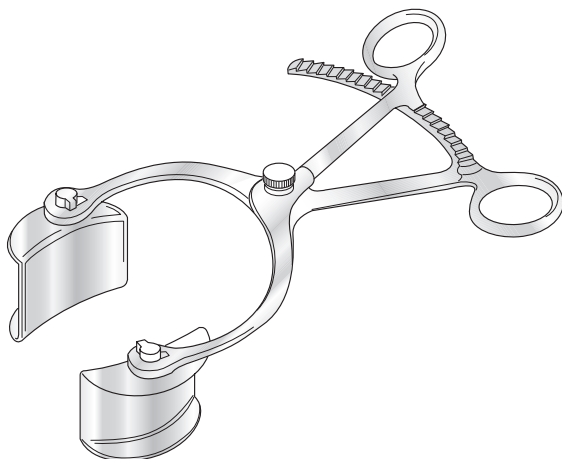

Code	Description
fos-GI/370	Swivel blades: 38 x 60mm, bivalve, 254mm long

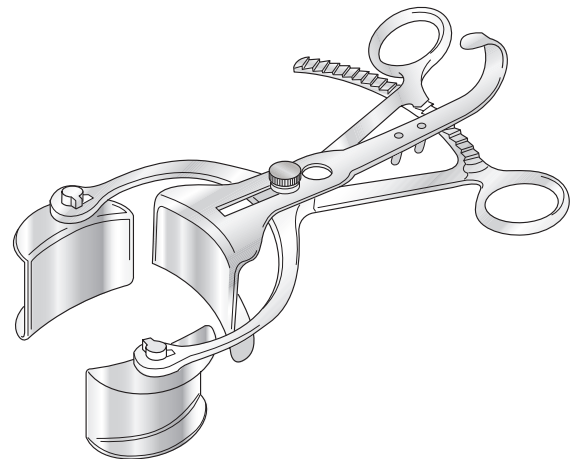

Code	Description
fos-GI/371	Swivel blades: 38 x 59mm, trivalve, 203mm long

Bowlby Dilator

Curved

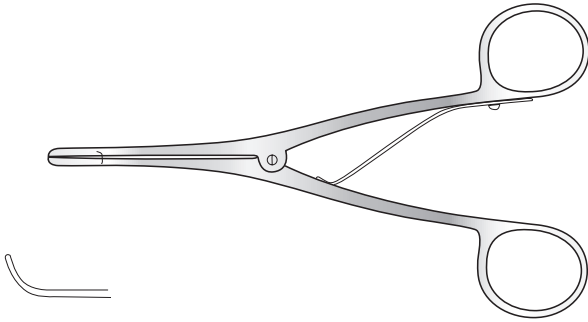

Code	Description
fos-GI/495	145mm long

Travers Retractor

Self retaining with internal rack, 210mm long

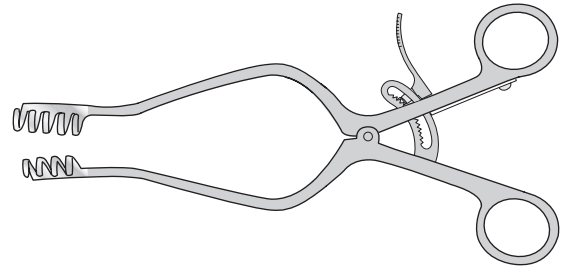

Code	Description
fos-GI/323	4 x 5 teeth, 95mm fully open

Irwin Retractor

Self retaining, with cam rack, 4 x 4 teeth

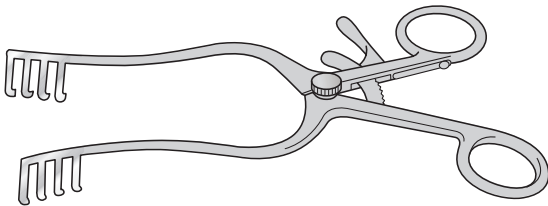

Code	Description
fos-GI/324	178mm long

West Retractor

Self retaining, 140mm long

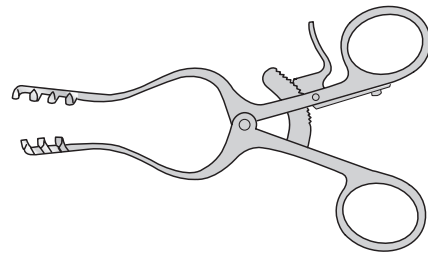

Code	Description
fos-GI/326	3 x 4 teeth, 60mm fully open
fos-GI/326cr	3 x 4 teeth, 60mm fully open, with cam rack

Norfolk and Norwich Retractor

4 x 5 teeth 50mm blades x 223mm long

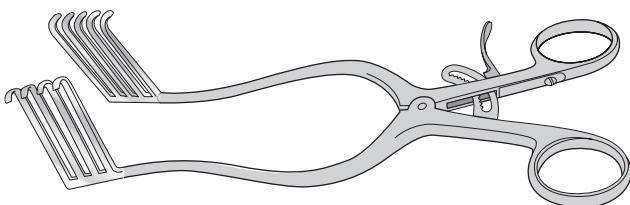

Code	Description
fos-GI/325	Standard rack

Weitlander Retractor

3-4 teeth

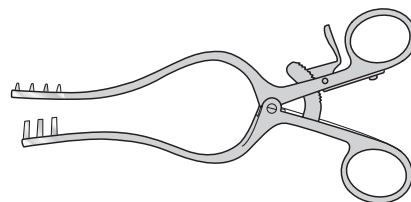

135mm long

Code	Description
fos-GI/496	Blunt
fos-GI/496a	Sharp
fos-GI/496b	Sharp, 2-3 teeth
fos-GI/496c	Blunt, 2-3 teeth

165mm long

Code	Description
fos-GI/497	Blunt
fos-GI/497a	Sharp

Retractors

Kocher Retractor



230mm long

Code	Description
fos-GI/378	36 x 20mm blade

250mm long

Code	Description
fos-GI/378a	67 x 25mm blade
fos-GI/378b	80 x 42mm blade
fos-GI/378c	80 x 50mm blade
fos-GI/378d	80 x 60mm blade

Canny Ryall Navy Retractor

Double-ended, with one single hook blade 5mm wide, and one fenestrated blade

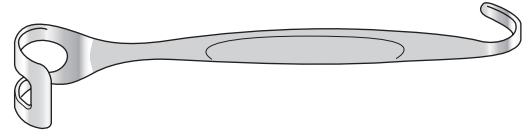

Code	Description
fos-GI/343	Fenestrated blade 16mm wide, 190mm long
fos-GI/343a	Fenestrated blade 19mm wide, 190mm long
fos-GI/343b	Fenestrated blade 25mm wide, 220mm long
fos-GI/343c	Fenestrated blade 30mm wide, 220mm long

Kocher Langenbeck Retractor

215mm long

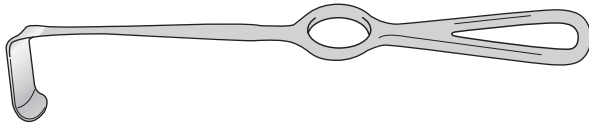

Code	Description
fos-GI/336sp	25 x 6mm blade
fos-GI/379a	35 x 8mm blade
fos-GI/379b	35 x 11mm blade
fos-GI/379c	35 x 15mm blade
fos-GI/357sp	41 x 11mm blade

Code	Description
fos-THO/cutsp015	55 x 11mm blade
fos-GI/379d	70 x 15mm blade
fos-GI/379e	80 x 12mm blade
fos-GI/379f	80 x 16mm blade

Canny Ryall Army Retractor

Double prong, 13mm wide, 165mm long



Code	Description
fos-GI/342	Large, 19mm wide
fos-GI/342a	Small, 11mm wide

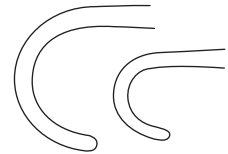

Langenbeck Retractor

Single ended

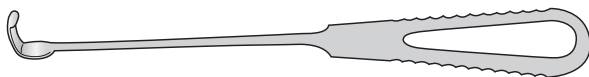

Code	Description
fos-GI/336	Blade 22mm x 6mm
fos-GI/337	Blade 45mm x 13mm
fos-GI/337a	Blade 65mm x 13mm
fos-GI/338a	Blade 75mm x 25mm
fos-GI/338a1	Blade 65mm x 25mm

Czerny Retractor

Double ended

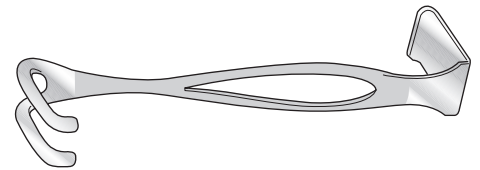

Code	Description
fos-GI/341	171mm long

Landon Retractor

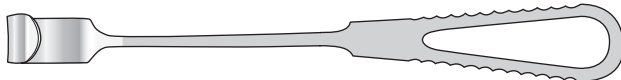

Code	Description
fos-GI/494	230mm



Lane Retractor

Double ended blade, 229mm long

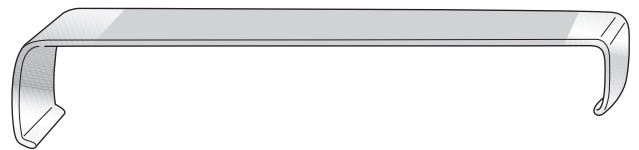

Code	Description
fos-GI/339	13mm x 19mm wide
fos-GI/340	25mm x 32mm wide

Morris Retractor

Single blade, 229mm long

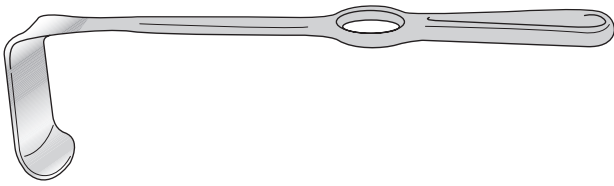

Code	Description
fos-GI/330	38 x 51mm
fos-GI/331	51 x 51mm
fos-GI/332	64 x 51mm

Morris Retractor

Double ended, 216mm long

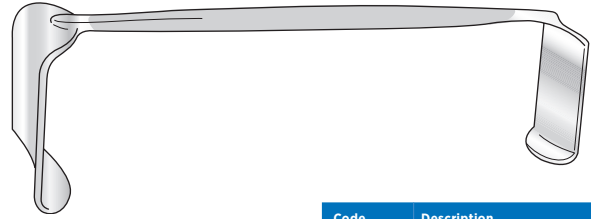

Code	Description
fos-GI/327	32 x 51mm and 38 x 51mm
fos-GI/328	44 x 51mm and 51 x 51mm
fos-GI/329	64 x 51mm and 38 x 51mm

Moynihan Retractor

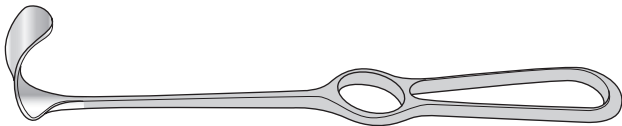

Code	Description
fos-GI/462	Single ended, blade 13 x 22mm, 215mm long

Deaver Abdominal Retractors



Code	Description
fos-GI/306	Set of 5, 315mm overall length
fos-GI/307	25mm wide
fos-GI/308	25mm wide
fos-GI/309	38mm wide
fos-GI/310	51mm wide
fos-GI/311	76mm wide

Elliot (Modified Deaver) Retractor

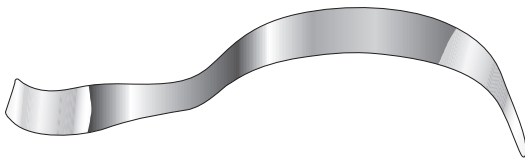

Code	Description
fos-GI/308M	With flat handle

Dyball and Lock Retractor

For liver

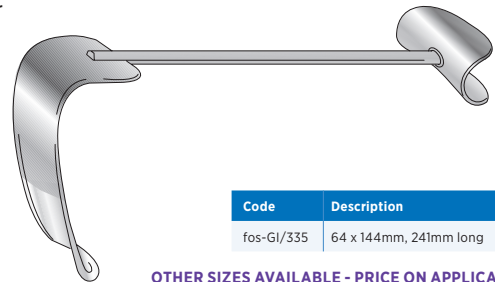

Code	Description
fos-GI/335	64 x 144mm, 241mm long

OTHER SIZES AVAILABLE - PRICE ON APPLICATION

Deaver Abdominal Retractors

With round handles

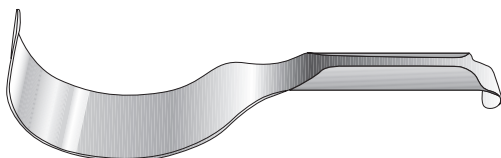

Code	Description
fos-GI/312	Set of 5, 305mm overall length
fos-GI/313	25mm wide
fos-GI/314	25mm wide
fos-GI/315	38mm wide
fos-GI/316	51mm wide
fos-GI/317	76mm wide

Kelly Retractor Blade

267mm long



Code	Description
fos-GI/333	38 x 191mm
fos-GI/334	57 x 191mm

Retractors

Durham Retractor

With fenestrated blade, 216mm long

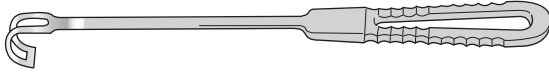

Code	Description
fos-GI/300	10mm wide
fos-GI/301	14mm wide
fos-GI/302	20mm wide

Ballance (Volkman) Retractor

203mm long

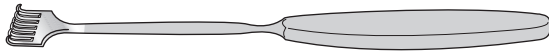

Sharp

Code	Description
fos-GI/463	1 prong
fos-GI/463a	2 prong
fos-GI/463b	3 prong
fos-GI/463c	4 prong
fos-GI/463d	6 prong

Blunt

Code	Description
fos-GI/463e	1 prong
fos-GI/463f	2 prong
fos-GI/463g	3 prong
fos-GI/463h	4 prong
fos-GI/463i	6 prong

Volkman Retractor



Code	Description
fos-OR/400	Sharp, 220mm long
fos-OR/400a	Blunt, 220mm long
fos-OR/400b	Sharp, 245mm long

Kilner Retractor

Double ended, cat's paw



Code	Description
fos-PL/056	152mm long

Kocher Retractor

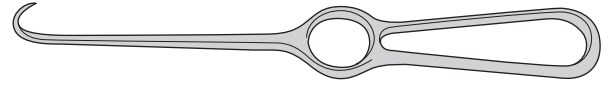

Code	Description
fos-OR/N036c	Sharp, 205mm long
fos-OR/N036	Sharp, 220mm long
fos-OR/N036b	Blunt, 220mm long

Senn-Miller Retractor

170mm long

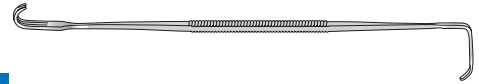

Code
fos-SH/5881

Single Hook Retractor

Sharp



Code	Description
fos-GI/SH5671	152mm long
fos-PL/065b	Half size, fine

Gillies Skin Hook

Solid handle, 190mm long



Code	Description
fos-PL/065a	Standard, fine
fos-PL/065b	Half size, fine

Dissectors and Probes

MacDonald Dissector Double Ended



Code	Description
fos-GI/285	191mm long

Probe, Sinus Silver



Code	Description
fos-GI/464	152mm long

Brodie Director Probe Ended, Silver Plated



Code	Description
fos-GI/286	165mm long

Probe, Fish Tail Silver Plated



Code	Description
fos-GI/293	127mm long
fos-GI/294	152mm long
fos-GI/295	203mm long
fos-GI/296	254mm long

Watson Cheyne Dissector

Fine, double-ended, with probe end



Code	Description
fos-GI/287	127mm long
fos-GI/288	191mm long
fos-GI/288a	230mm long
fos-GI/288b	255mm long

Jobson Horne Probe Dressing (Aural)

With one flat tapered end, serrated edge and one small ring end, stainless steel



Code	Description
fos-GI/297	140mm long
fos-GI/298	178mm long

Probe, Malleable Silver Plated



Code	Description
fos-GI/289a	127mm long
fos-GI/289	152mm long
fos-GI/290	178mm long
fos-GI/291	203mm long
fos-GI/292	255mm long
fos-GI/292a	305mm long

Miscellaneous

Aneurysm Needle

Small, for infusions



Code	Description
fos-GI/472a	146mm long

Syme Aneurysm Needle

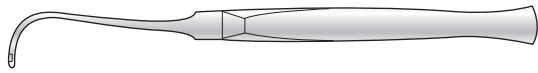

Code	Description
fos-GI/473	165mm long

Ring Cutter

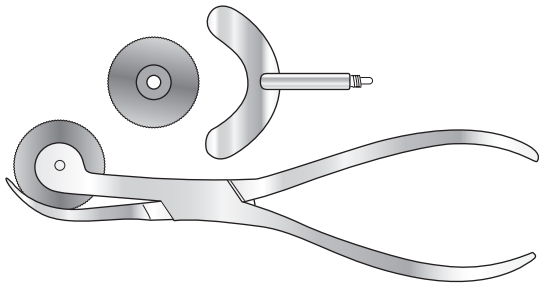

Code	Description
fos-GI/452	Circular saw blade, 165mm long
fos-GI/452a	Spare blade

Mayo Instrument Pin

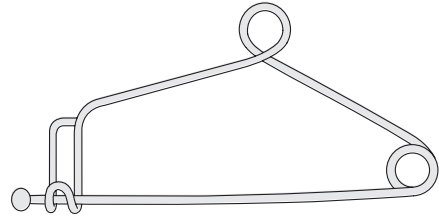

Code	Description
fos-GI/355	102mm long
fos-GI/356	152mm long

Baron Scalpel Handle

130mm long



Code	Description
fos-PM/003	No 3
fos-PM/004	No 4

Scalpel Handle

127mm long

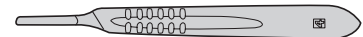

Code	Description
fos-PM/007	No 3
fos-PM/008	No 4
fos-PM/008a	No 4 L
fos-PM/001a	No 7

Kidney Dish

Stainless steel

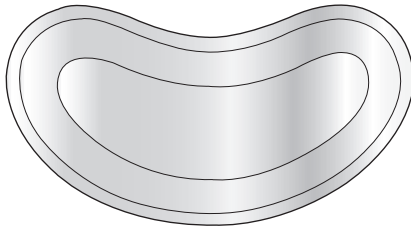

Code	Description
fos-GI/380	152mm
fos-GI/381	203mm
fos-GI/382	254mm
fos-GI/383	305mm

Cheate Jar

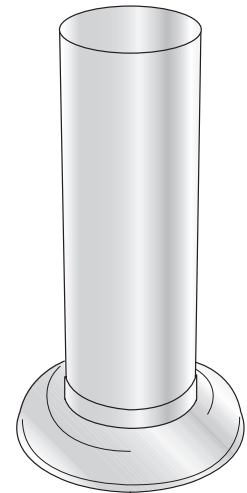

Code	Description
fos-GI/397	Stainless steel, 203mm x 50mm

Lotion Bowl

Without lid, stainless steel

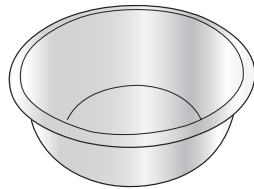

Code	Description
fos-GI/384	102mm
fos-GI/385	152mm
fos-GI/386	203mm
fos-GI/387	254mm
fos-GI/388	305mm

Measuring Jug



Code	Description
fos-GI/395	1 litre capacity

Instrument Tray

Stainless steel

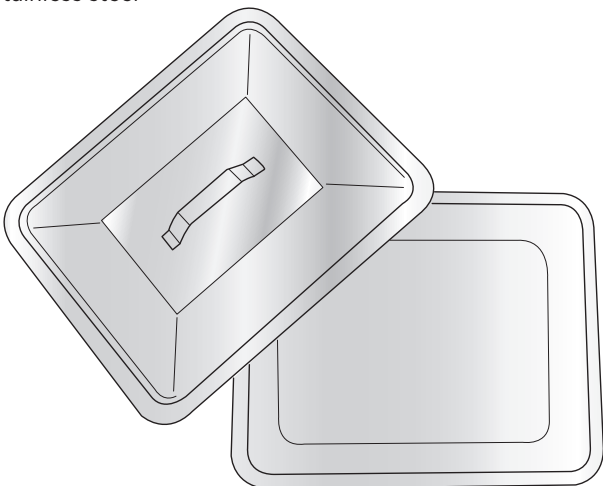

Code	Description
fos-GI/389	254 x 203 x 50mm
fos-GI/390	Lid only for 254 x 203 x 50mm
fos-GI/391	305 x 254 x 50mm
fos-GI/392	Lid only for 305 x 254 x 50mm
fos-GI/393	356 x 305 x 50mm
fos-GI/394	Lid only for 356 x 305 x 50mm

Petri Dish



Code	Description
fos-SH/002149	100mm, stainless steel, with lid

Gallipot

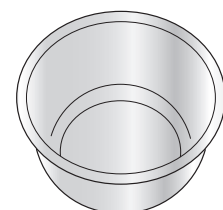

Code	Description
fos-GI/396	Stainless steel, 63mm

Silicone Matting & Sterilising Baskets

Silicone Matting

Medical grade for storage, sterilisation and transportation of instruments.

Cushion, protect, and organise delicate surgical instruments during storage, transportation, and sterilisation. Perforations allow for ventilation during the sterilisation process. The silicone mat can be cut to fit any size container.

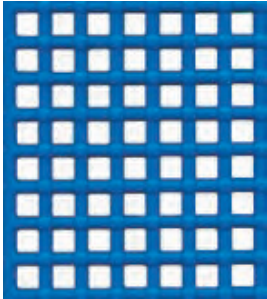

502mm long x 242mm wide
7mm holes, 10mm between holes

Code

BES/1004M

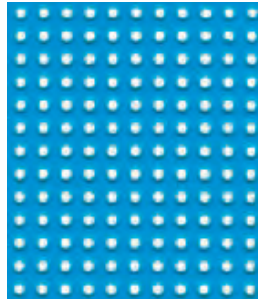

515mm long x 240mm wide
3mm holes, 6mm between holes

Code

BES/1001M

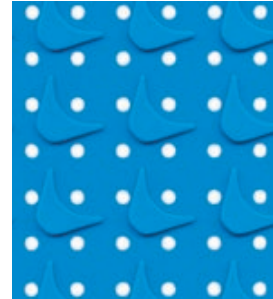

570mm long x 550mm wide
4mm holes, 13mm between holes

Code

BES/1002M

Sterilising Baskets

DIN Basket

Wire mesh base with perforated sides and two carrying handles

Code	Description
fos-GI/CO006	230 x 130 x 60mm
fos-GI/CO007	240 x 130 x 50mm
fos-GI/CO008	240 x 130 x 60mm
fos-GI/CO009	240 x 250 x 50mm
fos-GI/CO010	240 x 250 x 60mm
fos-GI/CO014	300 x 300 x 50mm
fos-GI/CO015	350 x 350 x 60mm
fos-GI/CO011	480 x 250 x 50mm
fos-GI/CO012	480 x 250 x 60mm

Code	Description
fos-GI/CO013	480 x 250 x 70mm
fos-GI/CO016	480 x 400 x 60mm
fos-GI/CO017	480 x 480 x 50mm
fos-GI/CO018	480 x 480 x 60mm
fos-GI/CO019	500 x 300 x 50mm
fos-GI/CO020	550 x 430 x 50mm
fos-GI/CO021	600 x 300 x 60mm



DIN Basket

Wire mesh basket with two carrying handles

Code	Description
fos-GI/CO022	240 x 250 x 50mm
fos-GI/CO023	240 x 250 x 60mm
fos-GI/CO024	240 x 250 x 70mm
fos-GI/CO031	300 x 300 x 60mm
fos-GI/CO025	480 x 250 x 50mm

Code	Description
fos-GI/CO026	480 x 250 x 60mm
fos-GI/CO027	480 x 250 x 70mm
fos-GI/CO028	480 x 250 x 100mm
fos-GI/CO029	480 x 480 x 50mm
fos-GI/CO030	480 x 480 x 70mm

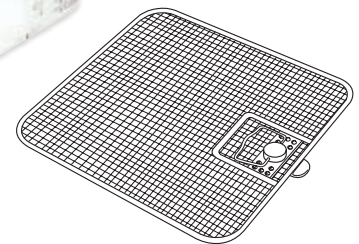

DIN Basket Lids

For perforated and wire mesh baskets

Code	Description
fos-GI/CO032	240 x 250mm
fos-GI/CO033	300 x 300mm
fos-GI/CO034	480 x 250mm
fos-GI/CO035	480 x 480mm

ENT Basket

Wire mesh base with perforated sides and two carrying handles, supplied with lid

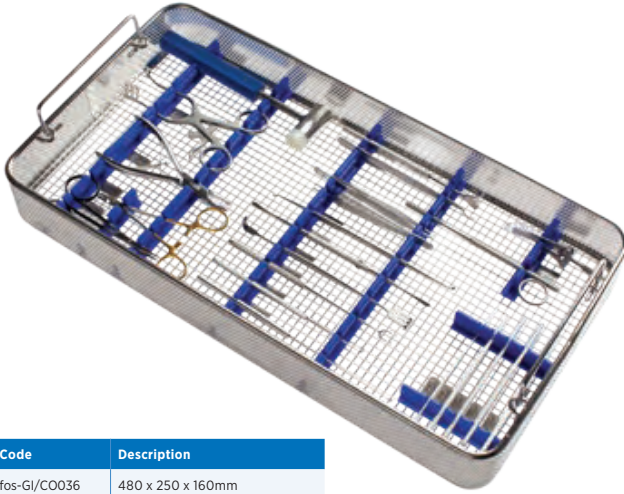

Code	Description
fos-GI/CO036	480 x 250 x 160mm
fos-GI/CO037	Fixing clamps

Arthroscope Basket

Wire mesh base with two fixing clamps

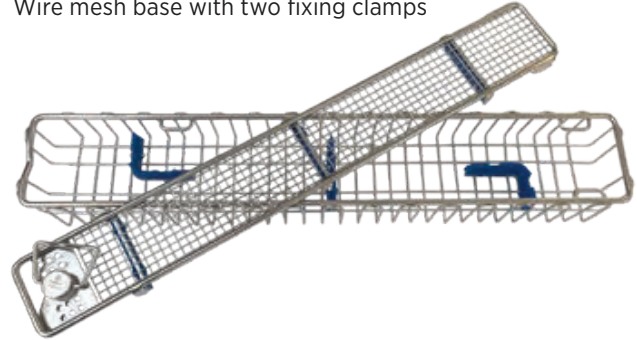

Code	Description
fos-GI/CO001	290 x 80 x 52mm

Endoscope Basket

With small lens basket

Code	Description
fos-GI/CO002	6400 x 150 x 77mm

Wire mesh base with two fixing clamps

Code	Description
fos-GI/CO003	S - 460 x 80 x 52mm
fos-GI/CO004	D - 480 x 80 x 52mm
fos-GI/CO005	D - 680 x 80 x 52mm

Sieve

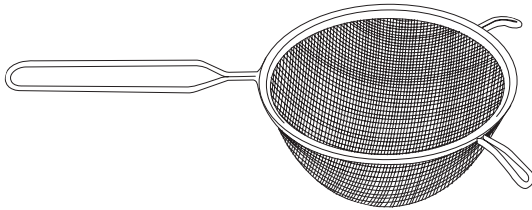

Code	Description
fos-GI/5071	203mm x 50mm ø

Fine Mesh Basket



With hinged take off / lockable lid

Code	Description
fos-GI/CO041	120 x 155 x 40mm
fos-GI/CO044	120 x 155 x 50mm
fos-GI/CO042	235 x 155 x 40mm
fos-GI/CO045	235 x 155 x 50mm
fos-GI/CO043	375 x 260 x 40mm

With separate lid

Code	Description
fos-GI/CO038	120 x 155 x 40mm
fos-GI/CO039	235 x 155 x 40mm
fos-GI/CO040	375 x 260 x 40mm

Optical Fibre Cables

Our optical fibre cables are compatible with all major scopes and illuminators. Every light lead is high temperature xenon compatible, rated to the highest level of thermal resistance and tested to ensure the highest light output possible.

Choice of 10 colours for easy identification

Choice of lengths and sheathing types

Free on-site light lead testing
We'll come and go through your lead stock to ensure your leads are fit for use

Reinforced for longer life

How to order

Select an option from each of the following steps to create your part number.

Part number = _____
 Step 1 Step 2 Step 3 Step 4 Step 5 Step 6 Step 7

Example: 474810180FRGY is a Storz Proximal, Storz Distal, 4.8mm Bundle, 254mm Length, Fully Reinforced Sheathing in Grey

Step 1: Proximal

All end tips are stainless steel

<p>ACMI</p> <p>Ø 0.299</p> <p>1</p>	<p>Wolf/Dyonics</p> <p>Ø 0.354</p> <p>2</p>	<p>Long Wolf</p> <p>Ø 0.354</p> <p>L2</p>
<p>Olympus/ACMI</p> <p>Retaining ring</p> <p>3</p>	<p>Storz</p> <p>4</p>	<p>Pilling</p> <p>5</p>
<p>Universal</p> <p>3/8-24 or 5/16-24 thread</p> <p>U</p>		

Step 2: Distal

All end tips are stainless steel

Wolf Snap On

6

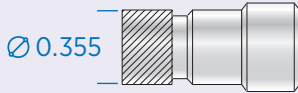

Storz

7

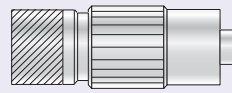

ACMI Snap-On

8

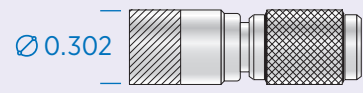

Olympus

9

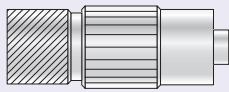

Wolf Clip-On

10

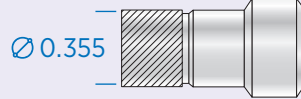

Pilling

11

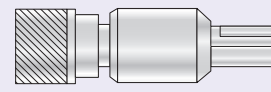

ACMI Clip-On

12

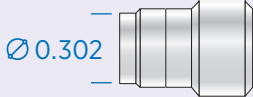

Mini Olympus

13

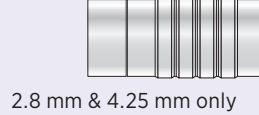

Universal

U

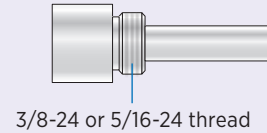

Step 3: Bundle Size

Place gauge on bundle to determine diameter

2.2mm

22

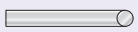

2.8mm

28

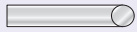

Mini Olympus only

3.0mm

30



3.8mm

38

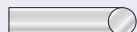

4.25mm

425



Mini Olympus only

4.8mm

48

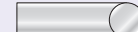

Step 4: Length

6ft

6

8ft

8

10ft

10

Call us for custom lengths

Step 5: Connector Angle

180°

180

45°

45

90°

90

Step 6: Sheathing Type

Non-reinforced

0

6" Reinforced*

6

Fully Reinforced*

FR

*Reinforced options are not available with clear sheathing

Step 7: Sheathing Colour

Black



BK

Blue

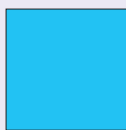

BL

Clear



CL

Green

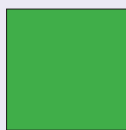

GR

Gray



GY

Red



RD

Pink



PK

White



WH

Yellow



YL

4.8mm only



Dental

Elevators	47
Extracting Forceps	48
Tooth Forceps	51
Wire Cutting Forceps	53

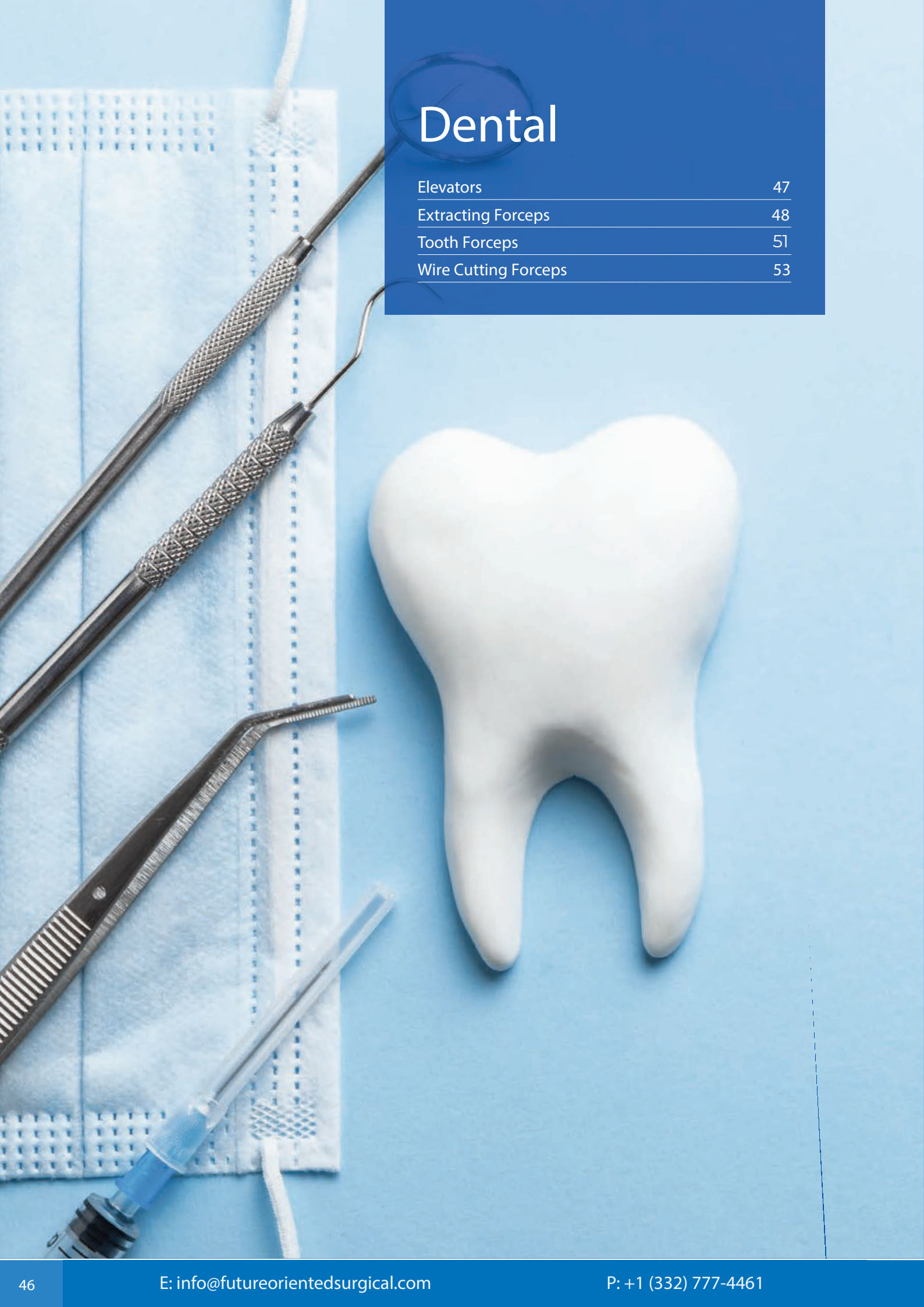

Extracting Forceps

Extracting Forceps

For lower molars with decayed or broken crowns either side molars
180mm long

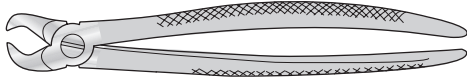

Code	Description
fos-DEN/8578	No 87



Extracting Forceps

For lower molars either side
165mm long

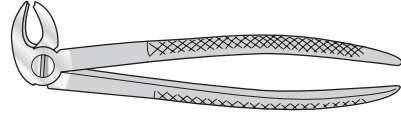

Code	Description
fos-DEN/8522	No 22

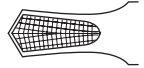

Extracting Forceps

For upper roots
180mm long

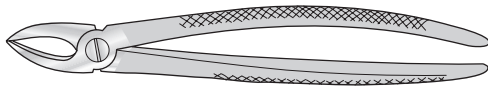

Code	Description
fos-DEN/8530	No 30

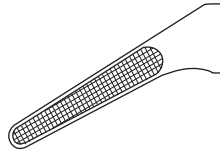

Extracting Forceps

For upper roots and incisors
165mm long

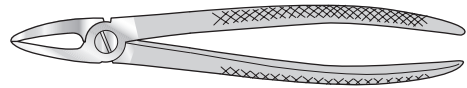

Code	Description
fos-DEN/8522a	No 29

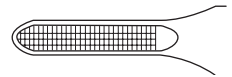

Extracting Forceps

For upper molars
180mm long

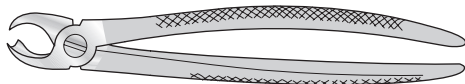

Code	Description
fos-DEN/8588	No 89
fos-DEN/8590	No 90

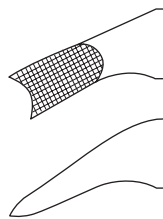

Extracting Forceps

For upper laterals and canines
170mm long

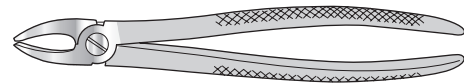

Code	Description
fos-DEN/8500	No 1, 6mm wide
fos-DEN/8502	No 1, 5mm wide

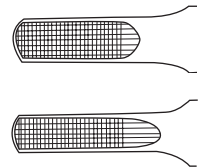

Extracting Forceps

For lower molars
165mm long

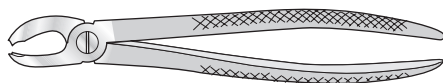

Code	Description
fos-DEN/8520	No 21

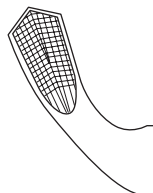

Extracting Forceps

For lower incisors and canines
170mm long

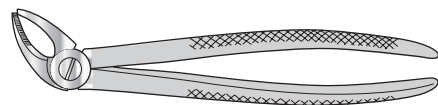

Code	Description
fos-DEN/8504	No 4, 4mm wide

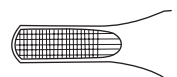

Extracting Forceps

Extracting Forceps

For lower premolars
170mm long

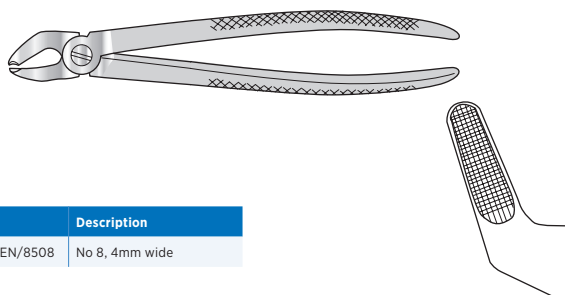

Code	Description
fos-DEN/8508	No 8, 4mm wide

Extracting Forceps

For lower molars
150mm long

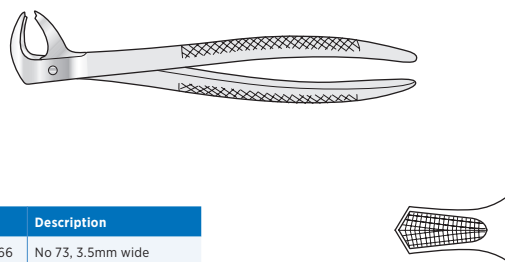

Code	Description
fos-DEN/8566	No 73, 3.5mm wide

Extracting Forceps

For lower bicuspid and canines
170mm long

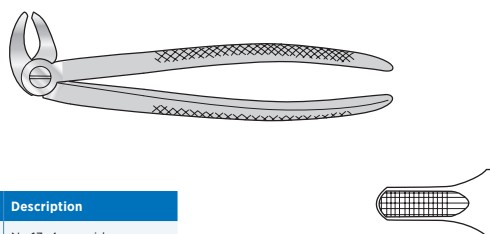

Code	Description
fos-DEN/8512	No 13, 4mm wide

Extracting Forceps

For lower roots
150mm long

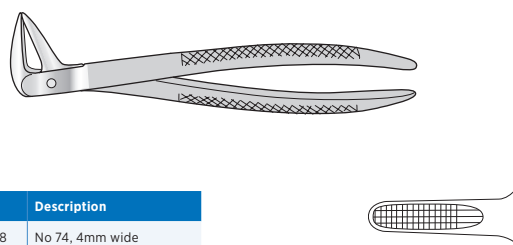

Code	Description
fos-DEN/8568	No 74, 4mm wide

Extracting Forceps

For upper premolar
180mm long

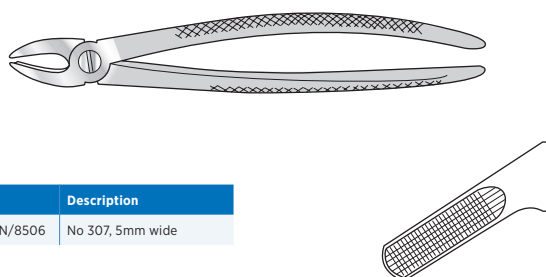

Code	Description
fos-DEN/8506	No 307, 5mm wide

Extracting Forceps

For lower roots and premolars
150mm long

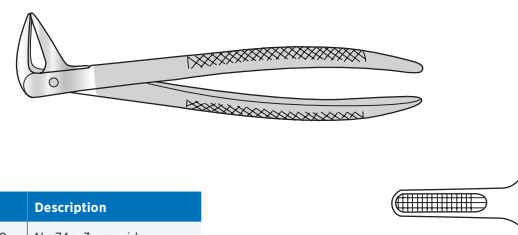

Code	Description
fos-DEN/8570	No 74n, 3mm wide

Extracting Forceps

For upper molars
180mm long

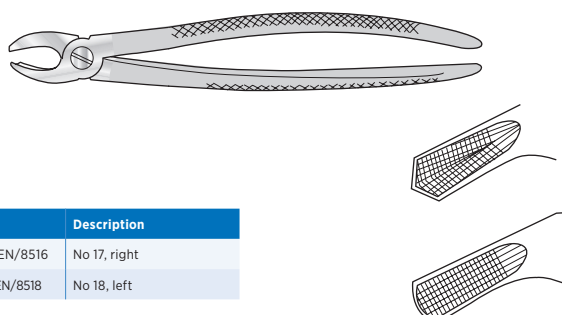

Code	Description
fos-DEN/8516	No 17, right
fos-DEN/8518	No 18, left

Extracting Forceps

For lower bicuspid and canines
150mm long

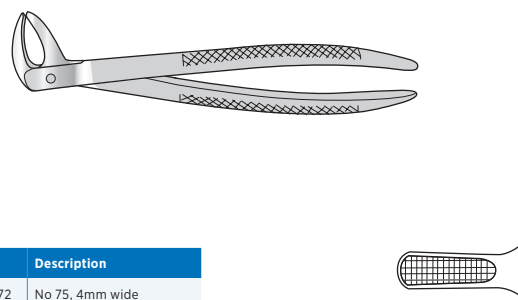

Code	Description
fos-DEN/8572	No 75, 4mm wide

Extracting Forceps

Extracting Forceps

For lower molars with decayed or broken crowns either side
150mm long

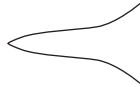
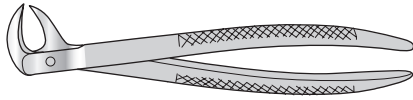

Code	Description
fos-DEN/8576	No 86a

Extracting Forceps

For upper roots, narrow
185mm long

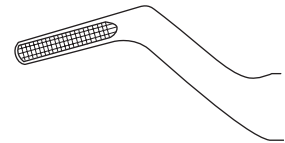
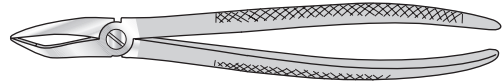

Code	Description
fos-DEN/8552	No 51a, 3mm wide

Extracting Forceps

For lower roots either side
165mm long

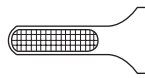
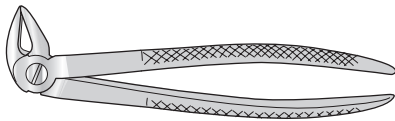

Code	Description
fos-DEN/8532	No 33, 3.5mm wide

Extracting Forceps

For upper wisdoms either side
185mm long

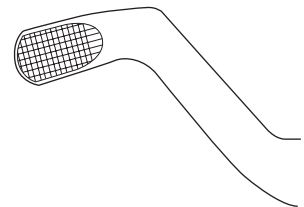
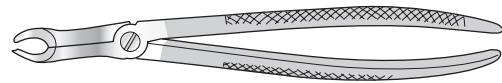

Code	Description
fos-DEN/8560	No 67, 7mm wide

Extracting Forceps

For upper roots
185mm long

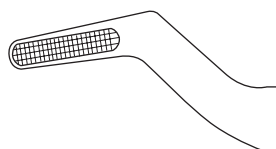
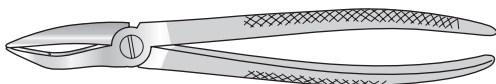

Code	Description
fos-DEN/8550	No 51, 4mm wide

Extracting Forceps

For lower wisdoms either side
185mm long

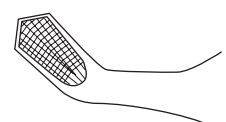
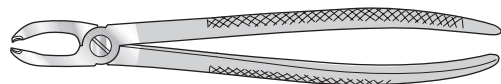

Code	Description
fos-DEN/8574	No 79, 5mm wide

Cryer Tooth Forceps

For upper incisors and roots
185mm long

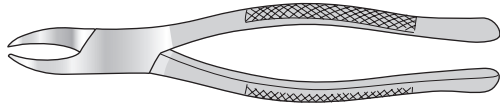

Code
fos-DEN/8010

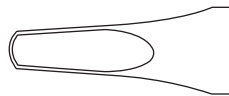

Cryer Tooth Forceps

For incisors and roots
185mm long

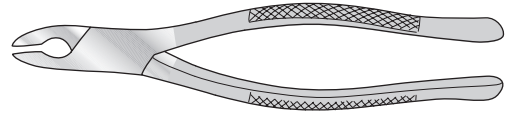

Code	Description
fos-DEN/8013	No 150a

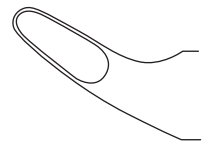

Cryer Tooth Forceps

For incisors and roots
185mm long

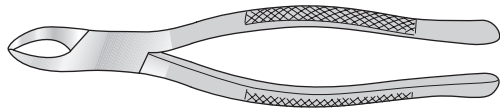

Code	Description
fos-DEN/8014	No 62

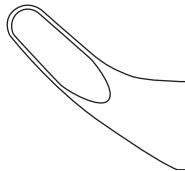

Tooth Forceps

For lower incisors, bicuspid and roots
185mm long

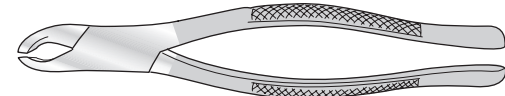

Code	Description
fos-DEN/8036	No 203

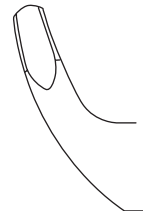

Cryer Tooth Forceps

For upper incisors and roots
185mm long

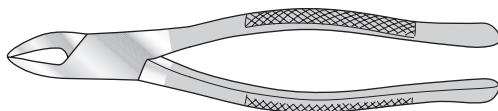

Code	Description
fos-DEN/8012	No 150

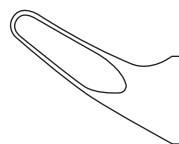

Tooth Forceps

For lower molars either side
185mm long

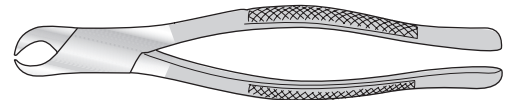

Code	Description
fos-DEN/8039	No 23

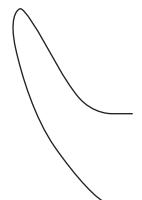

Tooth Forceps

Tooth Forceps

For lower molars
185mm long

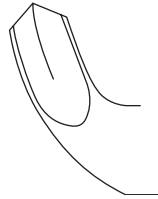
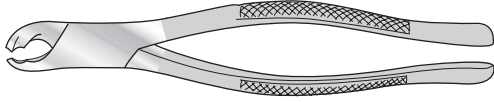

Code	Description
fos-DEN/8042	No 17

Tooth Forceps

For lower roots, incisors and bicuspid
175mm long

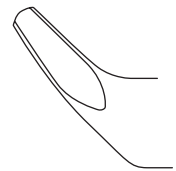
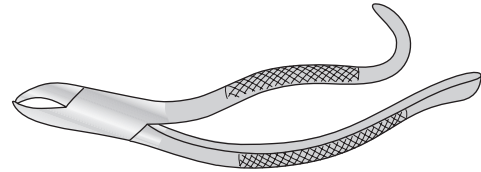

Code	Description
fos-DEN/8045	No 103

Tooth Forceps

For lower wisdom teeth
185mm long

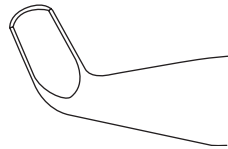
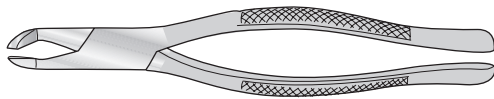

Code	Description
fos-DEN/8043	No 222

Tooth Forceps for Children

160mm long

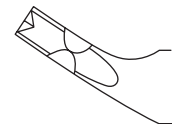
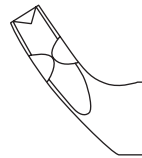
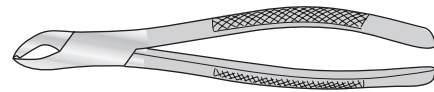

Code	Description
fos-DEN/8037	No 151as, for lower teeth

Code	Description
fos-DEN/8017	No 150as, for upper teeth

Tooth Forceps

For lower molars either side
175mm long

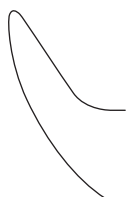
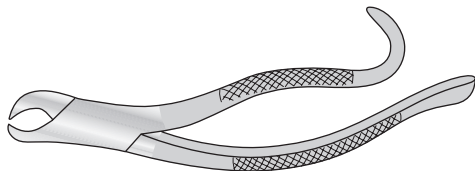

Code	Description
fos-DEN/8040	No 16

Cryer Tooth Forceps for Children

For upper incisors, canines and bicuspid,
160mm long

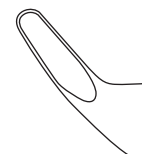
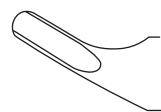
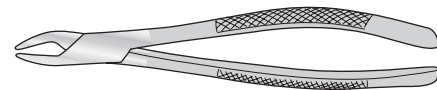

Code	Description
fos-DEN/8011	No 1505

Code	Description
fos-DEN/8033	No 1515

Top Cutting Forceps

Tungsten carbide edge, for bone pins up to 2.5mm \varnothing
gold handles

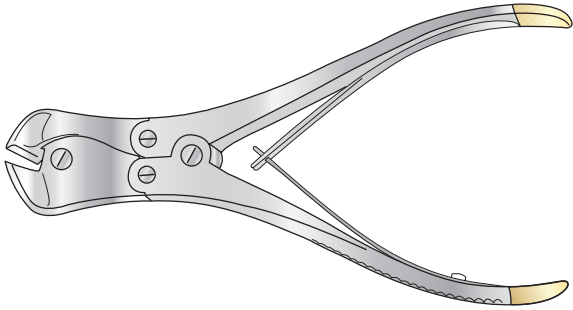

Code	Description
fos-B/06	215mm long

Side Cutting Forceps

Tungsten carbide edge, for bone pins up to 2.2mm \varnothing
gold handles

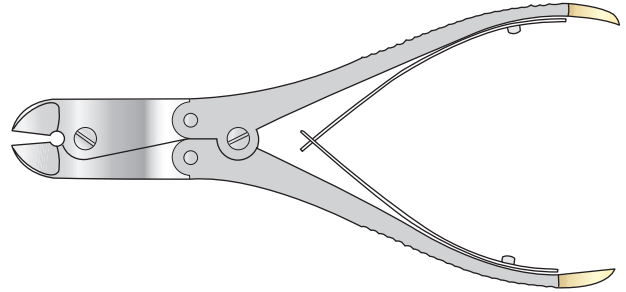

Code	Description
fos-B/332	230mm long

Top Cutting Forceps

Tungsten carbide edge, for arthrodesis wire up to 1.5mm \varnothing
gold handles

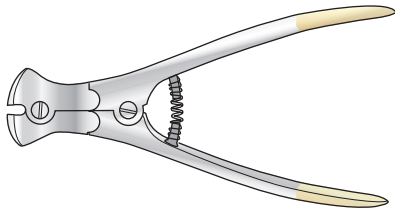

Code	Description
fos-B/06a	145mm long



Diathermy/ Bipolar

Diathermy Scissors	55
Diathermy Forceps	55
Bipolar Forceps	56
Handles, Needles and Blades	57
Leads	58
Quivers	58

Turner Warwick Diathermy Scissors

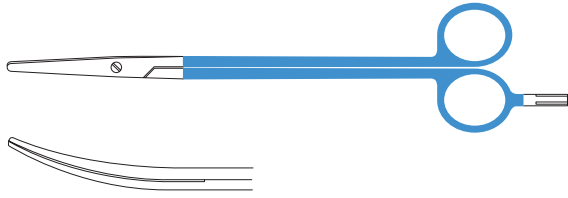

Straight

Code	Description
fos-DIA/072	190mm long
fos-DIA/073	230mm long
fos-DIA/074	250mm long

Curved

Code	Description
fos-DIA/075	190mm long
fos-DIA/076	230mm long
fos-DIA/077	250mm long

Riches Artery Forceps

Screw joint, curved

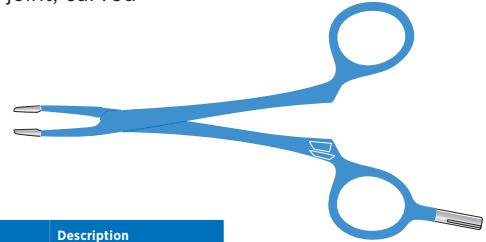

Code	Description
fos-DIA/014	127mm long
fos-DIA/015	152mm long
fos-DIA/016	178mm long
fos-DIA/017	185mm long
fos-DIA/018	228mm long

Adson Forceps

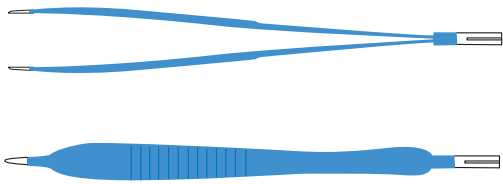

Code	Description
fos-DIA/003	152mm long

Wilson Hey Artery Forceps

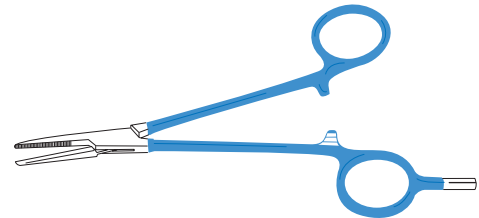

Straight

Code	Description
fos-DIA/023	152mm long
fos-DIA/024	178mm long
fos-DIA/025	185mm long
fos-DIA/026	228mm long

Curved

Code	Description
fos-DIA/019	152mm long
fos-DIA/020	178mm long
fos-DIA/021	185mm long
fos-DIA/022	228mm long

Dissecting Forceps



Serrated

Code	Description
fos-DIA/004	152mm long
fos-DIA/005	178mm long
fos-DIA/006	203mm long
fos-DIA/007	228mm long
fos-DIA/008	254mm long

1-2 teeth

Code	Description
fos-DIA/009	152mm long
fos-DIA/010	178mm long
fos-DIA/011	203mm long
fos-DIA/012	228mm long
fos-DIA/013	254mm long

Bipolar Forceps

Bipolar Forceps

Straight

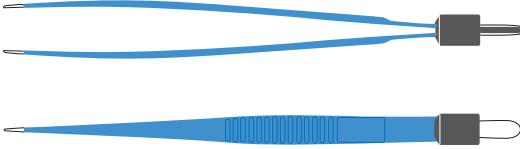

Fine tip

Code	Description
fos-DIA/034	101mm long
fos-DIA/035	127mm long
fos-DIA/036	152mm long
fos-DIA/037	178mm long
fos-DIA/038	185mm long

Medium tip

Code	Description
fos-DIA/039	101mm long
fos-DIA/040	127mm long
fos-DIA/041	152mm long
fos-DIA/042	178mm long
fos-DIA/043	185mm long

Heavy tip

Code	Description
fos-DIA/044	101mm long
fos-DIA/045	127mm long
fos-DIA/046	152mm long
fos-DIA/047	178mm long
fos-DIA/048	185mm long

Bipolar Forceps

Angled

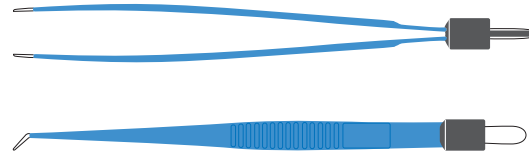

Fine tip

Code	Description
fos-DIA/049	101mm long
fos-DIA/050	127mm long
fos-DIA/051	152mm long
fos-DIA/052	178mm long
fos-DIA/053	185mm long

Medium tip

Code	Description
fos-DIA/054	101mm long
fos-DIA/055	127mm long
fos-DIA/056	152mm long
fos-DIA/057	178mm long
fos-DIA/058	185mm long

Heavy tip

Code	Description
fos-DIA/059	101mm long
fos-DIA/060	127mm long
fos-DIA/061	152mm long
fos-DIA/062	178mm long
fos-DIA/063	185mm long

Adson Bipolar Forceps

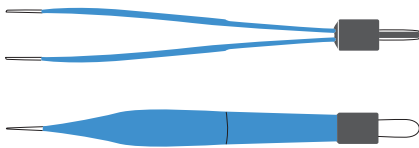

Code	Description
fos-DIA/003a	152mm long

Monel Handle



Code	Description
fos-DIA/028	145mm long

Monel Blade



Code	Description
fos-DIA/029	Fully insulated
fos-DIA/030	Non-insulated

Needle Handles



Code
fos-DIA/027

Needles

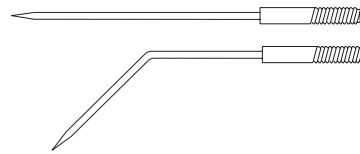

Straight

Code	Description
fos-DIA/064	Stout
fos-DIA/064a	Medium

Angled

Code	Description
fos-DIA/064b	Stout
fos-DIA/064c	Medium

Abbey Diathermy Needle

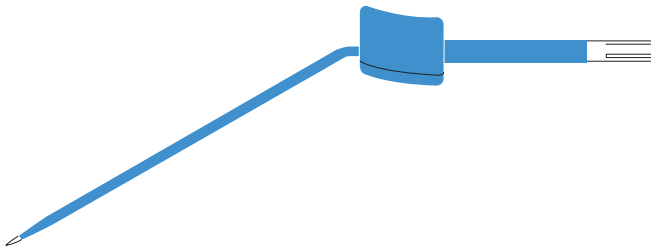

Code
fos-DIA/078

Diathermy Arm

With ball



Code	Description
fos-DIA/069	Curved
fos-DIA/069a	Straight

Finger Switch Pencil

With spatula and 3 metre lead



Code
fos-DIA/068

Spatula Blade

For diathermy finger



Code
fos-DIA/067a

Needle Point

For diathermy finger



Code
fos-DIA/067b

Leads and Quivers

Leads

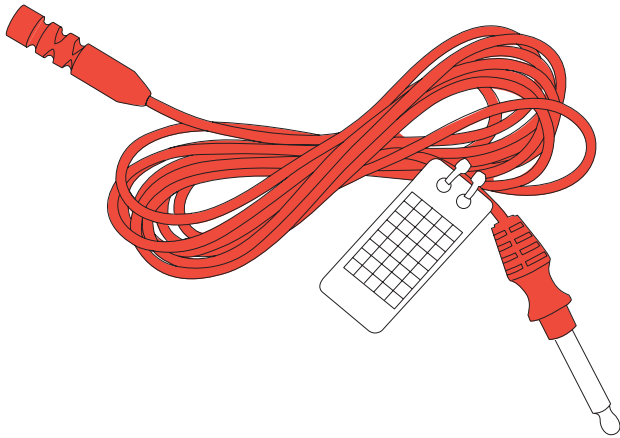

Code	Description
fos-DIA/065	4mm plug end
fos-DIA/066	8mm plug end

Bipolar Leads

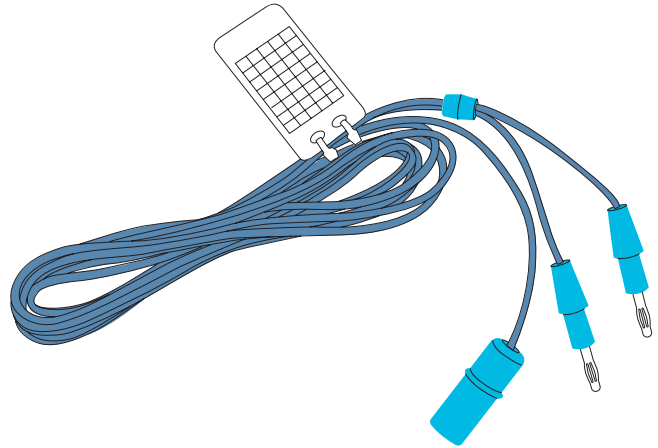

Code	Description
fos-DIA/067	Standard

Quiver

With hole in end, 232mm long

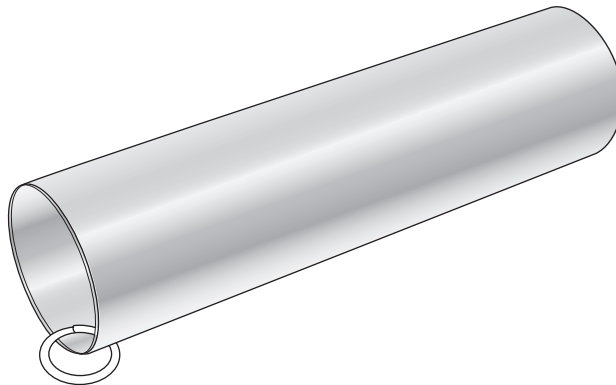

Code	Description
fos-DIA/001	Standard

Quiver

With hole in end, 232mm long

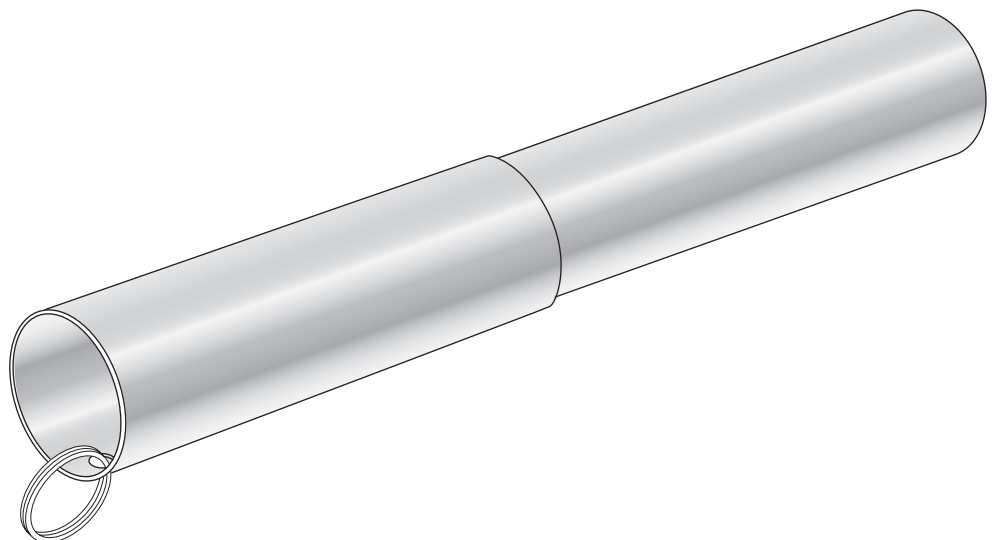

Code	Description
fos-DIA/002	Telescopic



ENT

Middle Ear Instruments	60
Picks and Scoops	62
Hooks and Probes	63
Retractors	64
Suction Tubes	65
Speculum	66
Aural Forceps	68
Artery Forceps	70
Tonsil, Turbinate and Septum Forceps	71
Dressing Forceps	72
Other Forceps	73
Mouth Gags	74
Tongue Plates and Depressors	75
Punches	76
Rongeurs	80
Scissors	82
Gouges, Knives and Elevators	84
Curettes and Myringotomes	85
Elevators and Dissectors	86
Miscellaneous	87

Middle Ear Instruments

Ironside Instruments

160mm long, black finish

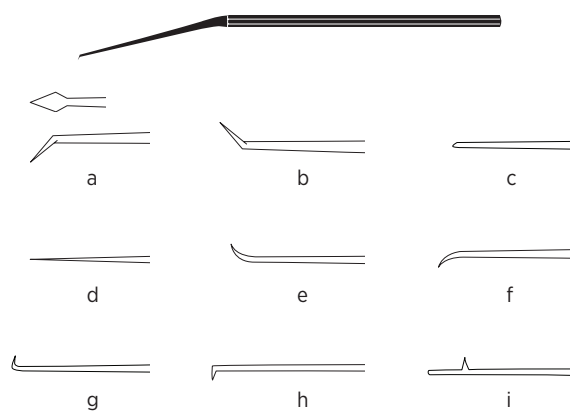

Code	Description
fos-ENT/200a	Knife 1, vertical incision
fos-ENT/200b	Knife 2, horizontal incision
fos-ENT/200c	Elevator
fos-ENT/200d	Needle point
fos-ENT/200e	Hook, superior elevation, angle 45°
fos-ENT/200f	Hook, inferior elevation, angle 45°
fos-ENT/200g	Hook, anterior elevation, angle 90° right
fos-ENT/200h	Hook, anterior elevation, angle 90° left
fos-ENT/200i	Measuring device

Rosen Instruments

160mm long, black finish

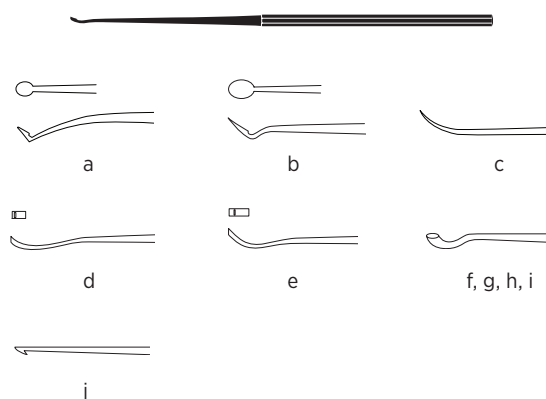

Code	Description
fos-ENT/202a	Curette, tympanic ring, small
fos-ENT/202b	Curette, tympanic ring, large
fos-ENT/202c	Probe, footplate movement test, fine
fos-ENT/202d	Mobiliser, slight curve
fos-ENT/202e	Mobiliser, full curve
fos-ENT/202f	Scoop, size 000
fos-ENT/202g	Scoop, size 00
fos-ENT/202h	Scoop, size 0
fos-ENT/202i	Scoop, size 1
fos-ENT/202j	Fenestrator, oval window

Schuknecht Instruments

160mm long, black finish

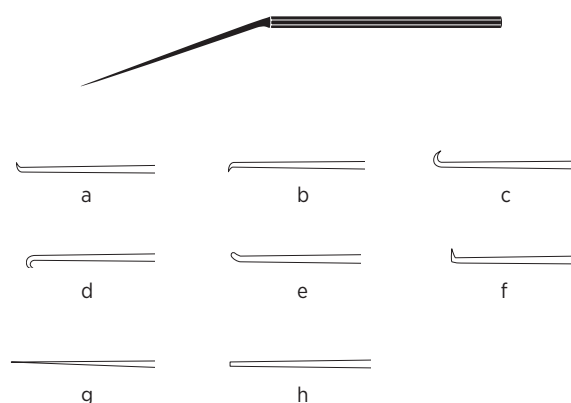

Code	Description
fos-ENT/201a	Hook upward, 0.4mm
fos-ENT/201b	Hook downward, 0.4mm
fos-ENT/201c	Hook upward, 0.7mm
fos-ENT/201d	Hook downward, 0.7mm
fos-ENT/201e	Elevator, oval
fos-ENT/201f	Hook, right-angled upward
fos-ENT/201g	Pick, straight
fos-ENT/201h	Spatula

Beale Instruments

165mm long, satin finish

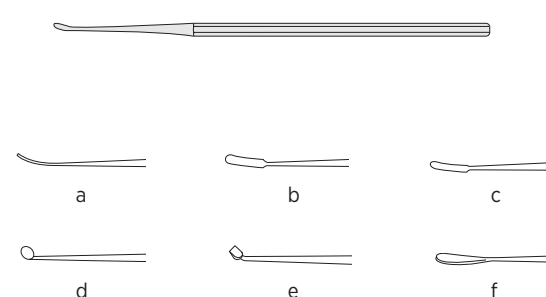

Code	Description
fos-ENT/204a	Tympanoplasty probe, fine blunt end
fos-ENT/204b	Raspatory, slight curve
fos-ENT/204c	Raspatory, slight curve, small
fos-ENT/204d	Rugine, double ended, sharp
fos-ENT/204e	Rugine, double ended
fos-ENT/204f	Spatula, graft smoothing

Beale Instruments

170mm long, satin finish

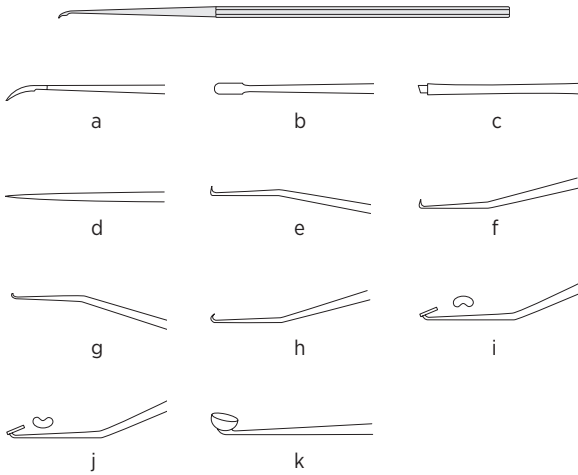

Code	Description
fos-ENT/203a	Knife, Stapedius tendon cutting
fos-ENT/203b	Raspatory, mucous removal
fos-ENT/203c	Osteotome, footplate
fos-ENT/203d	Perforator, elevation fixed footplate
fos-ENT/203e	Hook, removal of footplate, angled downward
fos-ENT/203f	Hook, removal of footplate, angled upward
fos-ENT/203g	Hook, bone removal from oval window, angled left
fos-ENT/203h	Applicator, vein graft for right ear
fos-ENT/203i	Applicator, vein graft for left ear
fos-ENT/203j	Curette, removal bony rim
fos-ENT/203k	Curette

Hough Instruments

165mm long, stainless steel

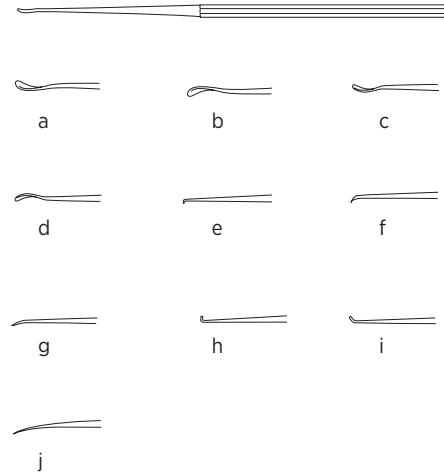

Code	Description
fos-ENT/205a	Excavator, "whirlybird", right, large
fos-ENT/205b	Excavator, "whirlybird", left, large
fos-ENT/205c	Excavator, "whirlybird", right, small
fos-ENT/205d	Excavator, "whirlybird", left, small
fos-ENT/205e	Pick, stapedectomy footplate, angled 90°, 0.33mm
fos-ENT/205f	Pick, stapedectomy footplate, angled 45°, 0.5mm
fos-ENT/205g	Pick, stapedectomy footplate, angled 15°, 0.5mm
fos-ENT/205h	Hook, "hoe", excavator, angled 90°
fos-ENT/205i	Hook, "hoe", excavator, angled 45°
fos-ENT/205j	Pick, curved

Cawthorne Hooks

165mm long, black finish

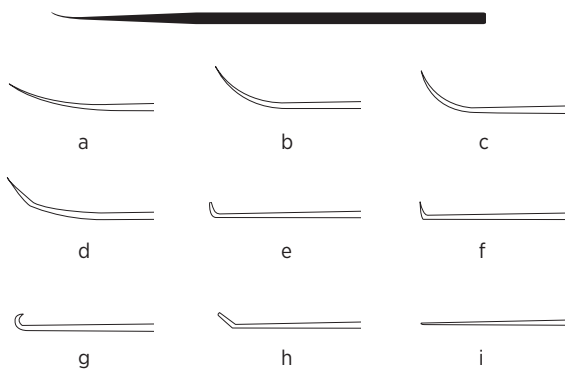

Code	Description
fos-ENT/206a	Slight curve
fos-ENT/206b	Medium curve
fos-ENT/206c	Full curve
fos-ENT/206d	Double curve
fos-ENT/206e	90° angle, 0.5mm
fos-ENT/206f	90° angle, 1.0mm
fos-ENT/206g	45° angle, 0.5mm
fos-ENT/206h	Retrograde
fos-ENT/206i	Straight

Picks and Scoops

Musgrove Cerumen Pick and Wool Carrier

Double ended



Code	Description
fos-ENT/024	178mm long

Formby Cerumen Scoop and Hook

Double ended



Code	Description
fos-ENT/026	178mm long

Hovell Loop

Fine, for removing hard wax



Code	Description
fos-ENT/027	152mm long

Lempert Scoop

Oval, 200mm long

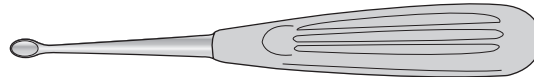

Code	Description
fos-ENT/066a	2mm x 2.5mm
fos-ENT/066b	2mm x 3.5mm
fos-ENT/066c	2mm x 4mm
fos-ENT/066d	2mm x 4.5mm
fos-ENT/066e	3mm x 5.5mm
fos-ENT/066f	3mm x 6mm

House Curette

Double ended, 180mm long



Code	Description
fos-S/6213	Straight
fos-S/6213a	Angled

Balance Scoop and Curette



Code	Description
fos-ENT/038	230mm long

Hartmann Hook

Sharp, straight shaft



Code	Description
fos-ENT/021	140mm long

Gardiner Brown Hook and Imray Loop

Double ended



Code	Description
fos-ENT/025	127mm long

Cawthorne Cerumen Hook

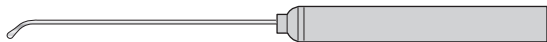

Code	Description
fos-ENT/023	143mm long

St Bart's Hook

Blunt, straight handle



Code	Description
fos-ENT/022	178mm long

Tracheal Hook

Sharp



Code	Description
fos-ENT/S15672	165mm long

McIndoe Skin Hook

Fine, with flat handle



Code	Description
fos-ENT/057	191mm long

Tracheal Single Hook Retractor

Sharp



Code	Description
fos-BSB671	152mm long

Cawthorne Probe

Silver, flattened end



Code	Description
fos-ENT/019	140mm long

Tracheal Double Hook

Blunt



Code	Description
fos-ENT/SB673	105mm long

Jobson Horne Probe

Double ended, serrated tip and smooth ring



Code	Description
fos-ENT/020a	140mm long
fos-ENT/020b	178mm long

Retractors

Mollison Retractor

Self retaining, curved

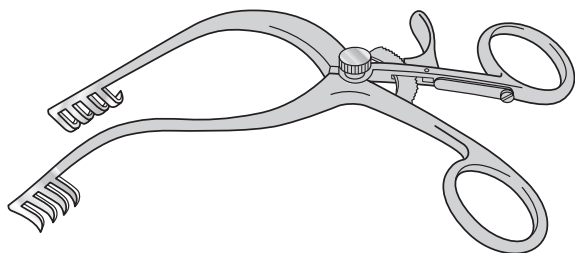

Code	Description
fos-ENT/034a	4-4 teeth, adult, 165mm long
fos-ENT/034b	2-2 teeth, child, 133mm long

Wallace Modified Plester Retractor

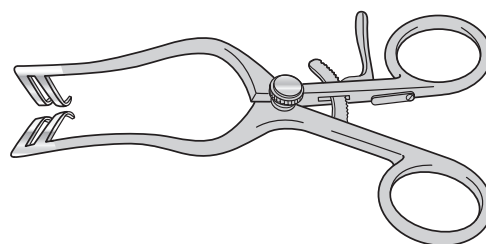

Code	Description
fos-ENT/062	2 x 2 teeth, 140mm long

Plester-Jansen Retractor

Solid blade one side,
140mm long

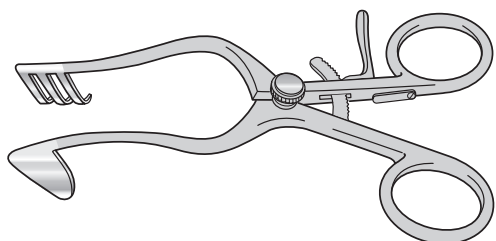

Code	Description
Sc-Ent/061A	Left
Sc-Ent/061B	Right
Sc-Ent/061C	3 x 3 Teeth

Shah Intra Aural Retractor

Satin finish
152mm long

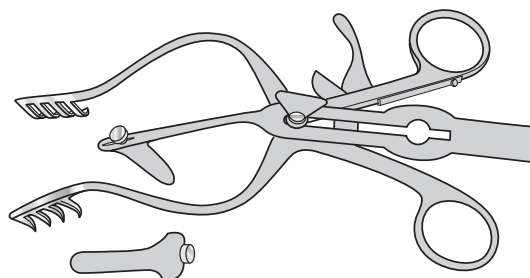

Code	Description
fos-ENT/060a	4-4 teeth, adult, 165mm long
fos-ENT/060b	Third blade
fos-ENT/060c	Intra aural blade
fos-ENT/060d	Post aural blade

Hurd Pillar Retractor and Tonsil Dissector



Code	Description
fos-ENT/147	197mm long

Mollison Anterior Pillar Retractor and Tonsil Enucleator

Semi sharp



Code	Description
fos-ENT/148	210mm long

Ipswich Pattern Sucker

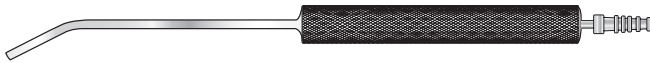

Code	Description
fos-ENT/050a	267mm long

Lempert Suction and Irrigation Tubes

With tucker valve and stilette for cleaning stainless steel, 203mm



Code	Description
fos-ENT/044	6F.G. 2mm
fos-ENT/044a	9F.G. 3mm

Formby Suction Tube

Angled, conical, tip size 10 F.G. stainless steel

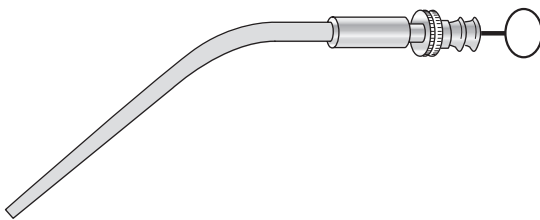

Code	Description
fos-ENT/042	210mm long

Magill Suction Tubes

Set of four with conical ends, one curved, three angled, handle, stainless steel, 210mm



Code	Description
fos-ENT/045	Various sizes
fos-ENT/046a	3.0mm ø
fos-ENT/046b	3.5mm ø
fos-ENT/046c	4.0mm ø

Barron Suction Tube

Small size, 4 F.G. Not for use with Zoellner ends

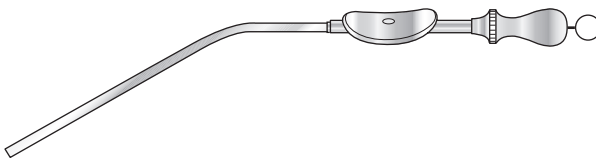

Code	Description
fos-ENT/041	229mm long

Zoellner Suction Tube

With stilette, stainless steel

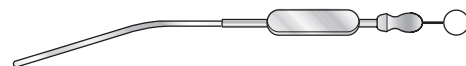

Code	Description
fos-ENT/047	170mm long, 2mm ø



House Suction and Irrigation Tubes

Stainless steel, 152mm long

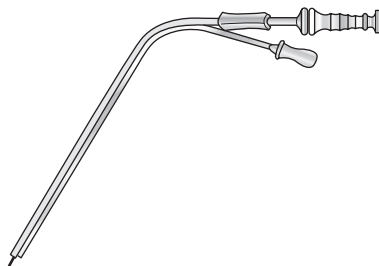

Code	Description
fos-ENT/043	8 F.G. x 6 F.G.
fos-ENT/043a	10 F.G. x 7 F.G.
fos-ENT/043b	12 F.G. x 8 F.G.

Rowbotham Suction Tube

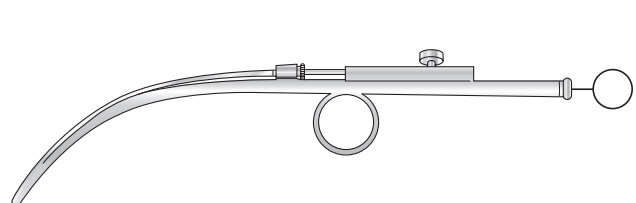

Code	Description
fos-ENT/169	286mm long

Speculum

Rosen Slotted Speculum

Set of four, round ends, black finish
38mm long

Code	Description
fos-ENT/049j	Set of 4
fos-ENT/049f	4mm
fos-ENT/049g	5mm
fos-ENT/049h	6mm
fos-ENT/049i	7mm



Tumarkin Speculum

Set of eight, tapered slot, black finish
50mm long

Code	Description
fos-ENT/052	Set of 8
fos-ENT/053a	4.5mm ø
fos-ENT/053b	6.5mm ø
fos-ENT/053c	7.0mm ø
fos-ENT/053d	7.5mm ø
fos-ENT/053e	8.0mm ø
fos-ENT/053f	8.5mm ø
fos-ENT/053g	9.0mm ø
fos-ENT/053h	11.0mm ø

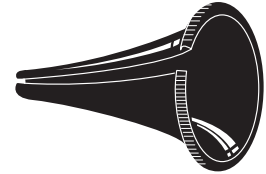

Rosen Aural Speculum

Round, 40mm long

Code	Description
fos-ENT/049a	3mm
fos-ENT/049b	4mm
fos-ENT/049c	5mm
fos-ENT/049d	6mm
fos-ENT/049e	7mm

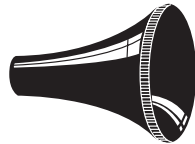

Heath Speculum

Set of four, black finish
50mm long

Code	Description
fos-ENT/207e	Set of 4
fos-ENT/207a	4.0mm ø
fos-ENT/207b	5.0mm ø
fos-ENT/207c	6.0mm ø
fos-ENT/207d	7.0mm ø



Shea Speculum

Set of five, oblique ends, black finish, 38mm long

Code	Description
fos-ENT/050	Set of 5
fos-ENT/051	3mm
fos-ENT/051a	4mm
fos-ENT/051b	5mm
fos-ENT/051c	6mm
fos-ENT/051d	7mm



Peters Seigle Speculum

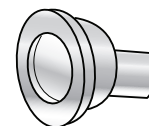

Code	Description
fos-ENT/366	Peters ear speculum black chrome finish set of 5, sizes 0 to 4
fos-ENT/189i	2.2mm x 3.2mm
fos-ENT/189j	2.8mm x 4.2mm
fos-ENT/189k	4.3mm x 5.8mm
fos-ENT/189l	5.2mm x 7.6mm
fos-ENT/189m	6.0mm x 7.6mm
fos-ENT/189d	6mm
fos-ENT/189e	7mm
fos-ENT/189f	8mm
fos-ENT/189g	9mm
fos-ENT/189h	10mm

St Clair Thompson Nasal Speculum

Code	Description
fos-ENT/072	38mm long
fos-ENT/072a	51mm long
fos-ENT/072b	64mm long
fos-ENT/072c	89mm long

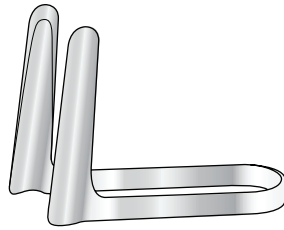

Killian Nasal Speculum

With Stop

Code	Description
fos-ENT/081a	51mm blade
fos-ENT/081b	64mm blade
fos-ENT/081c	76mm blade
fos-ENT/081d	89mm blade

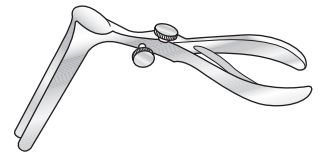

Without Stop

Code	Description
fos-ENT/082b	76mm blade

Thudichum Nasal Speculum

Set of seven, sizes 1-7,
70mm long

Code	Description
fos-ENT/073a	Standard
fos-ENT/073b	Insulated

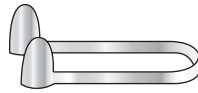

Standard

Code	Description
fos-ENT/073a	Size 1 - 12mm blade
fos-ENT/073a	Size 2 - 14mm blade
fos-ENT/073a	Size 3 - 16mm blade
fos-ENT/073a	Size 4 - 18mm blade
fos-ENT/073a	Size 5 - 20mm blade
fos-ENT/073a	Size 6 - 22mm blade
fos-ENT/073a	Size 7 - 24mm blade
fos-ENT/073a	Size 8 - 27mm blade

Insulated

Code	Description
fos-ENT/073b	Size 1 - 12mm blade
fos-ENT/073b	Size 2 - 14mm blade
fos-ENT/073b	Size 3 - 16mm blade
fos-ENT/073b	Size 4 - 18mm blade
fos-ENT/073b	Size 5 - 20mm blade
fos-ENT/073b	Size 6 - 22mm blade
fos-ENT/073b	Size 7 - 24mm blade
fos-ENT/073b	Size 8 - 27mm blade

Lempert Endaural Speculum

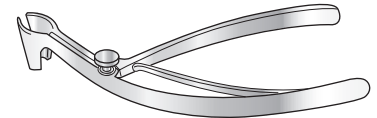

Code	Description
fos-ENT/060e	133mm long

Pilcher Nasal Speculum

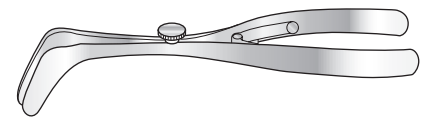

Code	Description
fos-ENT/071	152mm

Cottle Nasal Speculum

127mm long



Code	Description
fos-ENT/192c	20mm blade
fos-ENT/192b	32mm blade
fos-ENT/192	41mm blade
fos-ENT/192a	60mm blade

Aural Forceps



Triangular Jaw

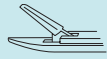

Smooth Jaw

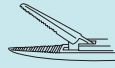

Serrated Jaw



Tenaculum Jaw

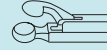

Cup Jaw

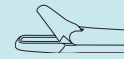

Grunwald Punch

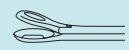

Henckel Jaw

Beale Aural Forceps

Micro, black finish, triangular flat jaws, serrated



Code	Description
fos-ENT/183	70mm to shoulder

Hough Aural Forceps

Micro, extra fine oval cup jaws, black finish



Code	Description
fos-ENT/059	70mm to shoulder

Cawthorne Aural Forceps

Micro, black finish, extra fine
70mm to shoulder



Code	Description
fos-ENT/182	Smooth jaws
fos-ENT/199	Serrated jaws

Ormerod Aural Forceps

Micro, extra fine, black finish
70mm to shoulder



Code	Description
fos-ENT/184a	Serrated, angled upwards
fos-ENT/184b	1mm cup jaw
fos-ENT/184c	Elongated cup jaw, 0.5 x 4mm

Hartmann Aural Forceps

Micro, black finish
75mm to shoulder

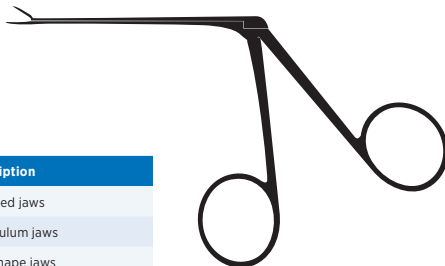

Code	Description
fos-ENT/058	Serrated jaws
fos-ENT/058a	Tenaculum jaws
fos-ENT/058b	Cup shape jaws
fos-ENT/058c	Curved left, serrated
fos-ENT/058d	Curved right, serrated
fos-ENT/058e	Angled up, serrated
fos-ENT/058f	Serrated jaws, satin finish
fos-ENT/058s	Pre-sterile - single use only

Shea Aural Forceps

Micro, oval cup jaw, black finish
70mm to shoulder

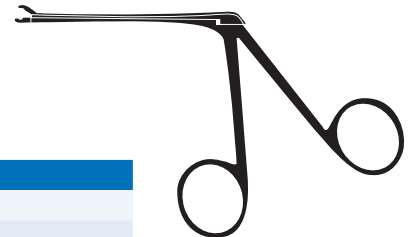

Code	Description
fos-ENT/069	Standard
fos-ENT/069a	Curved to left
fos-ENT/069b	Curved to right
fos-ENT/069c	Curved upward

Hartmann Aural Forceps

Standard, satin finish
75mm to shoulder

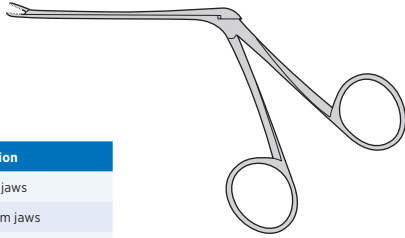

Code	Description
fos-ENT/181	Serrated jaws
fos-ENT/181a	Tenaculum jaws
fos-ENT/181b	Cup shape jaws
fos-ENT/181c	Grunwald punch action

Heath Aural Forceps

Light, with lifting discs, serrated jaws

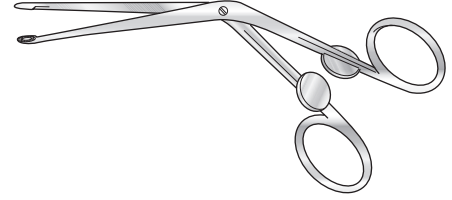

Code	Description
fos-ENT/175	83mm to shoulder

Henckel Aural Forceps

Fine fenestrated scoop blades

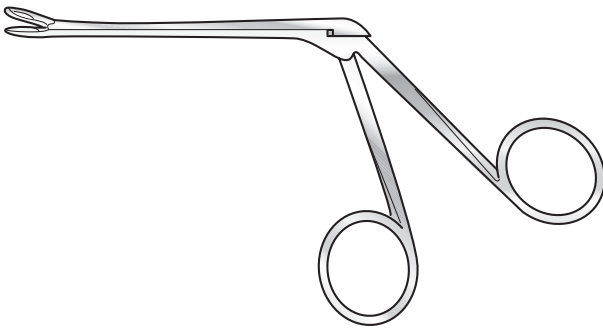

Code	Description
fos-ENT/176	75mm to shoulder

Struycken Cutting Forceps

75mm to shoulder

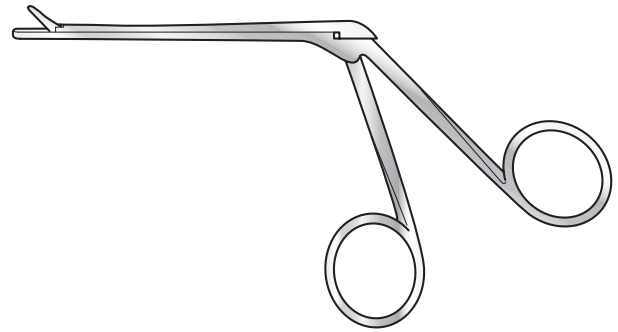

Code	Description
fos-ENT/178	Fenestrated under jaw

Artery Forceps

Birkett Tonsil Artery Forceps

Fine, 178mm long

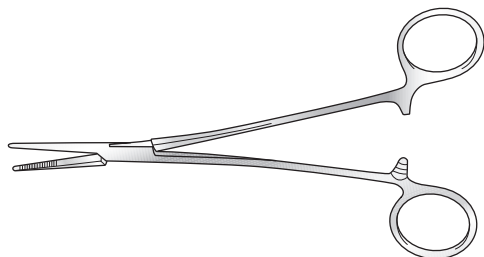

Code	Description
fos-ENT/151a	Straight
fos-ENT/151b	Curved

Negus Tonsil Artery Forceps

180mm long

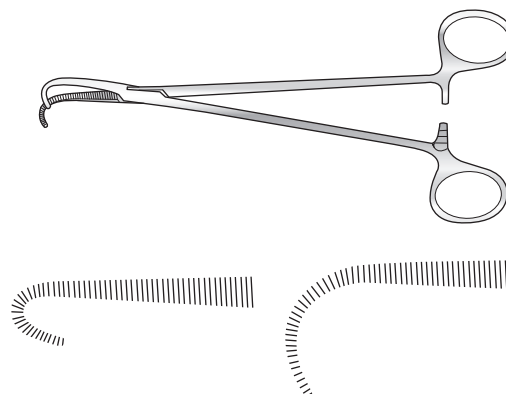

Code	Description
fos-ENT/197	Large curve
fos-ENT/197a	Small curve

Denis Browne Tonsil Artery Forceps

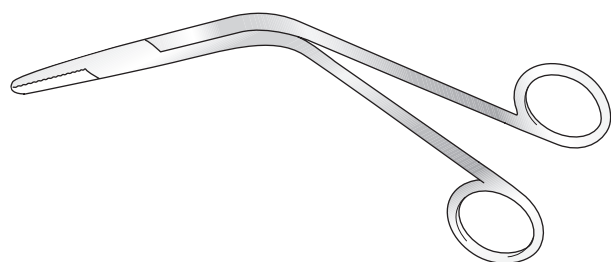

Code	Description
fos-ENT/155	216mm long

Sawtell Tonsil Artery Forceps

178mm long

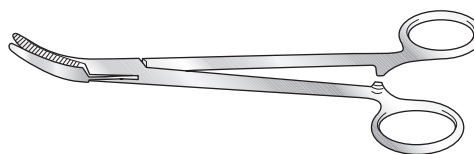

Code	Description
fos-ENT/152	Large curve
fos-ENT/153	Small curve

Fickling Artery Forceps

190mm long

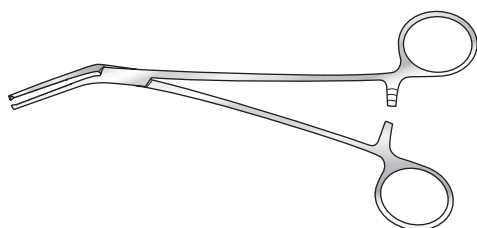

Code	Description
fos- E0 44b	1-2 teeth
fos- E0 44a	Serrated

Scott Tonsil Artery Forceps

Curved to side, screw joint

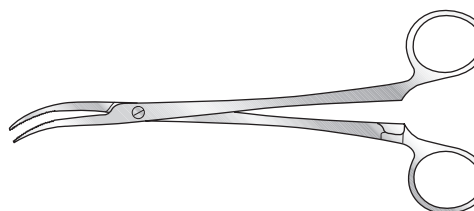

Code	Description
fos-ENT/154	180mm long

Tonsil, Turbinate and Septum Forceps

Denis Browne Tonsil Holding Forceps

Angled shanks, no rack

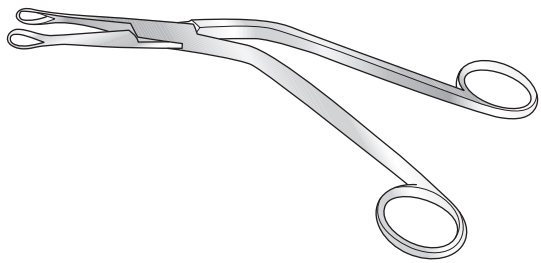

Code	Description
fos-ENT/144	200mm long

Jansen-Middleton Nasal Septum Forceps

Compound action
178mm long

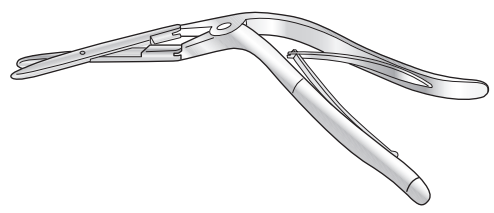

Code	Description
fos-Ø032	5mm jaw

Irwin Moore Nasal Turbinate Forceps

191mm long

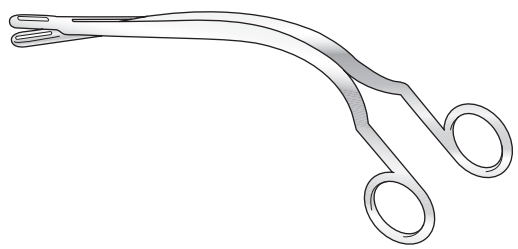

Code	Description
fos-ENT/077d	5mm jaw

Walsham Septum Forceps

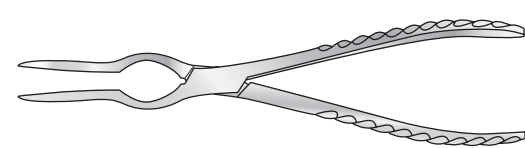

Code	Description
fos-Ø030a	Straight, 215mm long
fos-Ø030b	Right, 215mm long
fos-Ø030c	Left, 215mm long

Luc Nasal Turbinate Forceps

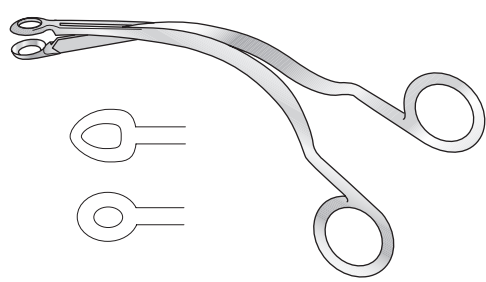

Heart shaped, 178mm long

Code	Description
fos-ENT/078a	Small 6mm ø
fos-ENT/078b	Medium 7.5mm ø
fos-ENT/078c	Large 9.0mm ø

Oval, 191mm long

Code	Description
fos-ENT/078d	Small 6mm ø
fos-ENT/078e	Medium 7.5mm ø
fos-ENT/078f	Large 9.0mm ø

Hartmann Conchotomes

Circular cutting
102mm to shoulder

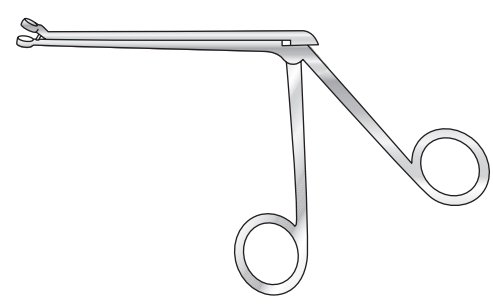

Code	Description
fos-ENT/080a	5mm ø
fos-ENT/080b	7mm ø
fos-ENT/080c	9mm ø
fos-ENT/080d	11mm ø

Dressing Forceps

Hartmann Dressing Forceps

Serrated jaw, screw joint

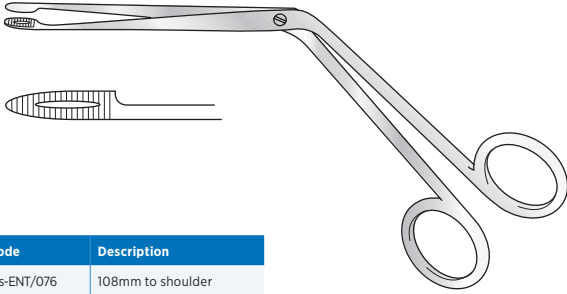

Code	Description
fos-ENT/076	108mm to shoulder

Wilde Dressing Forceps

Angular, serrated jaws

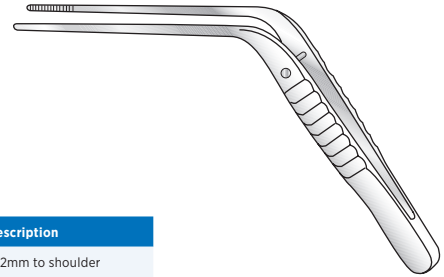

Code	Description
fos-ENT/075	102mm to shoulder

Tilley Dressing Forceps

Straight, fine, serrated ends

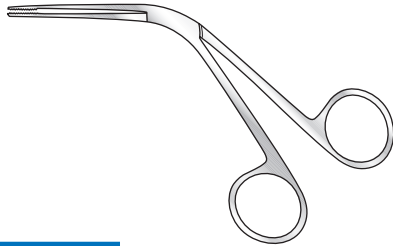

Code	Description
fos-ENT/077	2mm wide, 76mm to shoulder

Irwin Moore Thyroid Clamp

Thin jaws, angled to side

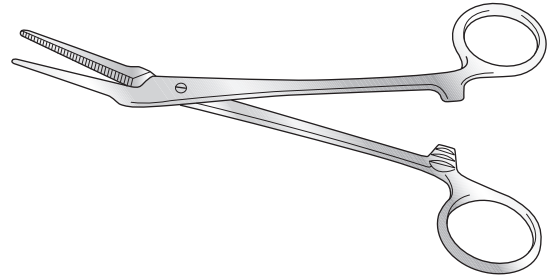

Code	Description
fos-ENT/170	165mm long

Trousseau Tracheal Dilator

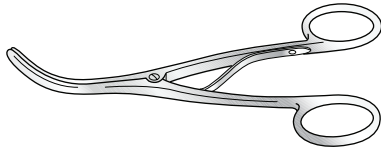

Code	Description
fos-ENT/172	Adult 140mm long
fos-ENT/172a	Child 125mm long

Wilson Bone Nibbling Forceps

Fine, curved, satin finish
152mm long

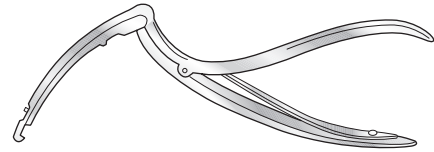

Code	Description
fos-ENT/054	Downward cutting - 3mm jaws
fos-ENT/055	Upward cutting - 3mm jaws

Cawthorne Nibbling Forceps

Narrow, 3mm jaws, wide handle

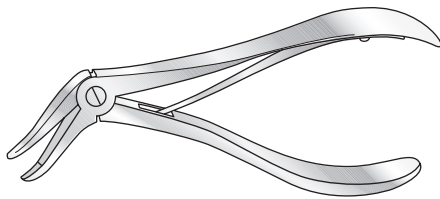

Code	Description
fos-ENT/068	159mm long

Denis Browne Collar Crushing Forceps

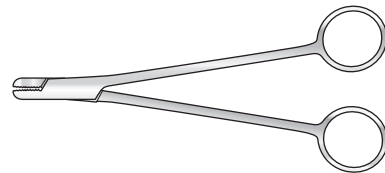

Code	Description
SH-4062	140mm long

Lempert Nibbling Forceps

152mm long



Code	Description
fos-ENT/067a	Straight, 2.5mm jaws
fos-ENT/067b	Angled, 3.0mm jaws

Mouth Gags

Doyen Mouth Gag

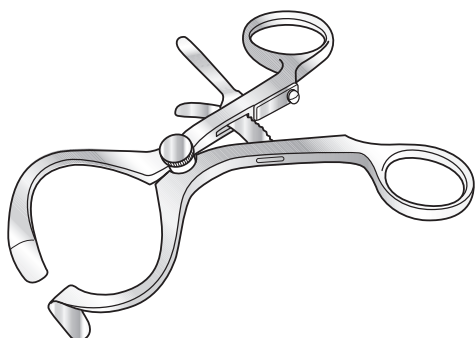

Code	Description
fos-ENT/88d	Adult
fos-ENT/88e	Child

Boyle-Davis Mouth Gag

Frame only

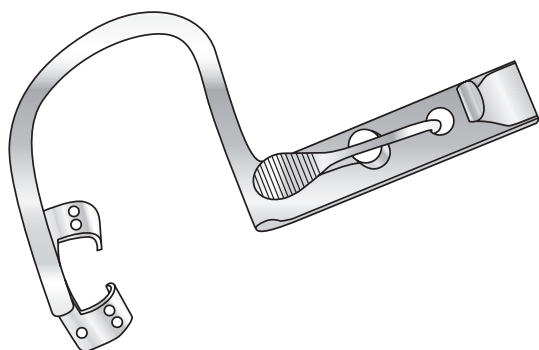

Code	Description
fos-ENT/083a	Adult
fos-ENT/083b	Child

Kilner Dott Mouth Gag

Frame only

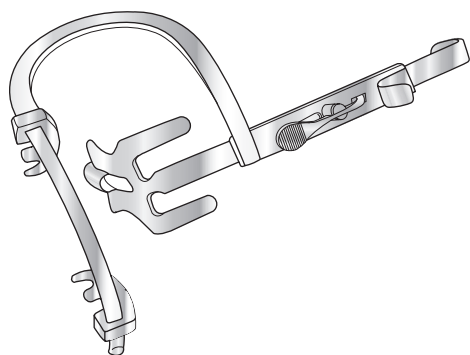

Code	Description
fos-ENT/087a	Adult
fos-ENT/088e	Set, including frame, small, medium, and large blades

Fergusson Ackland Mouth Gag

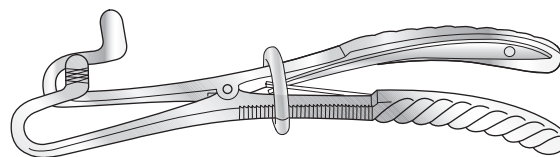

Code	Description
fos-ENT/209	Adult, 210mm
fos-ENT/209a	Child, 155mm

Mason Mouth Gag

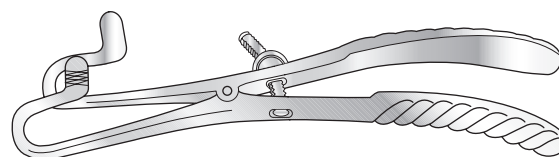

Code	Description
fos-ENT/210	Adult, 210mm

Draffin Bipod

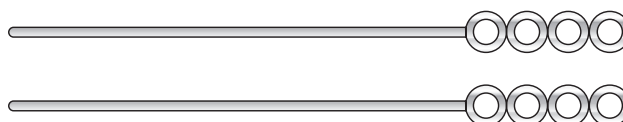

Adult

Code	Description
fos-ENT/083	Adult, 4 hole x 480mm long half circle end for use with a drape
fos-ENT/083E	Adult, 4 hole x 480mm long with round ends to be used with Magauran plate
fos-ENT/083E	Adult, 4 hole x 480mm long with round ends to be used with Magauran plate

Child

Code	Description
fos-ENT/083C	Child, 3 hole x 425mm long half circle end for use with a drape
fos-ENT/083D	Child, 3 hole x 425mm long with round ends to be used with Magauran plate
fos-ENT/083F	Child, 4 hole x 425mm long with round ends to be used with Magauran plate Alder Hey Children's Hospital pattern
fos-ENT/083D	Child, 3 hole x 425mm long with round ends to be used with Magauran plate
fos-ENT/083F	Child, 4 hole x 425mm long with round ends to be used with Magauran plate Alder Hey Children's Hospital pattern
SH-5104	Magauran plate 480mm - for use with Draffin bipods

Magauran Plate

Code	Description
SH-5104	480mm - for use with Draffin bipods

Doughty Tongue Plate

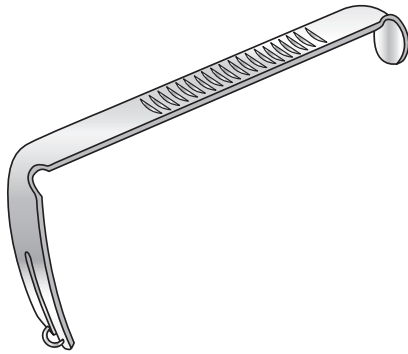

Plain

Code	Description
fos-ENT/084a	65mm - 1.6mm-1.9mm slot
fos-ENT/084b	75mm - 1.6mm-1.9mm slot
fos-ENT/084c	90mm - 4mm-4.5mm slot
fos-ENT/084d	100mm - 4mm-4.5mm slot
fos-ENT/084e	115mm - 4mm-4.5mm slot

Slotted

Code	Description
fos-ENT/085a	65mm - 1.6mm-1.9mm slot
fos-ENT/085b	75mm - 1.6mm-1.9mm slot
fos-ENT/085c	90mm - 4mm-4.5mm slot
fos-ENT/085d	100mm - 4mm-4.5mm slot
fos-ENT/085e	115mm - 4mm-4.5mm slot

With anaesthetic tube

Code	Description
fos-ENT/086a	65mm - 1.6mm-1.9mm slot
fos-ENT/086b	75mm - 1.6mm-1.9mm slot
fos-ENT/086c	90mm - 4mm-4.5mm slot
fos-ENT/086d	100mm - 4mm-4.5mm slot
fos-ENT/086e	115mm - 4mm-4.5mm slot

Kilner Dott Tongue Plate

With endotracheal tube groove

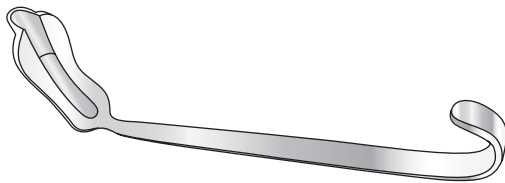

Code	Description
fos-ENT/088a	Small
fos-ENT/088b	Medium
fos-ENT/088c	Large
fos-ENT/088d	Extra small

Tongue Depressor

Flat stainless steel



Code	Description
fos-ENT/143	184mm long

Lack Tongue Depressor

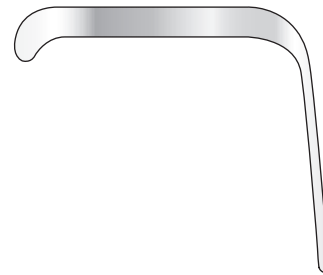

Code	Description
fos-ENT/142a	Child, 13mm wide
fos-ENT/142b	Adolescent, 19mm wide
fos-ENT/142c	Adult, 22mm wide

Punches

Nasal Cutting Forceps

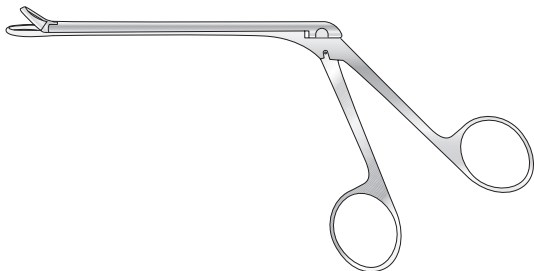

Myles

Through cutting, 120mm to shoulder

Code	Description
fos-ENT/SB889	12.5 x 3.5mm jaw

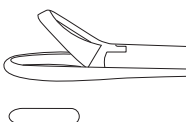

Gruenwald-Henke

Through cutting, 120mm to shoulder

Code	Description
fos-ENT/SB281	7 x 2mm jaw
fos-ENT/SB282	9 x 2.5mm jaw

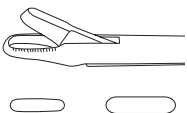

Struycken

Through cutting, 120mm to shoulder

Code	Description
fos-ENT/SB280	11 x 1mm jaw

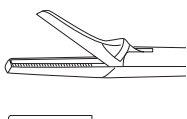

Gruenwald Nasal Punch Forceps

108mm to shoulder

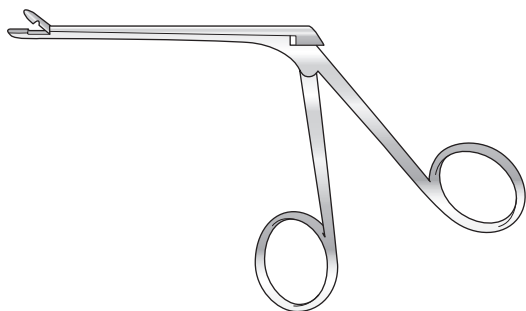

Code	Description
fos-ENT/077a	A fenestrated jaw, 3.5mm
fos-ENT/077b	Fenestrated lower jaw, narrow, 2.5mm
fos-ENT/077c	Fenestrated and tapered lower jaw, 2-3mm

Seymour Jones Antrum Punch Forceps

159mm long

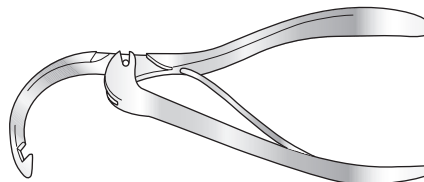

Code	Description
fos-ENT/132	4mm jaw

Backbiter

180mm long

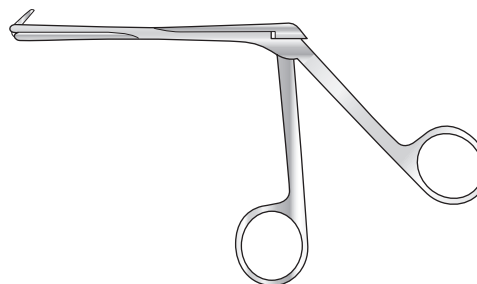

Code	Description
SH/4765b	7 x 3mm jaw

Backbiter

200mm long

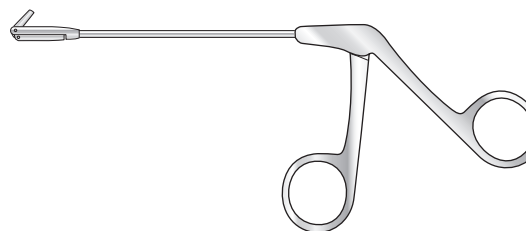

Code	Description
fos-ENT/5392	7 x 2mm jaw

Stammberger Rhinoforcep Antrium Punch

7mm x 3mm, 130mm long

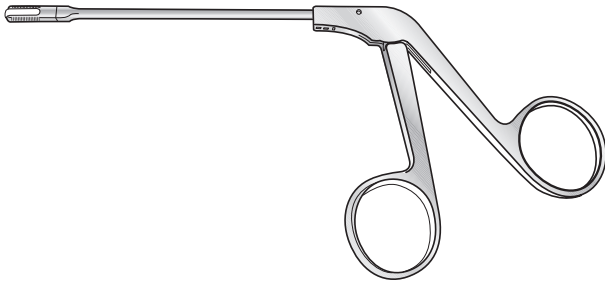

Code	Description
fos-ENT/234	Left back cut
fos-ENT/234a	Right back cut

Tilley Henckel Ethmoid Punch

Graduated shank, 114mm to shoulder

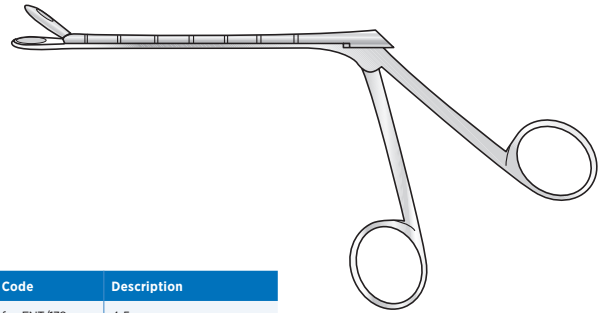

Code	Description
fos-ENT/138a	4.5mm
fos-ENT/138b	5.5mm
fos-ENT/138c	6.5mm
fos-ENT/138d	8mm

Ostrom Antrum Punch

Forcep, 178mm to shoulder

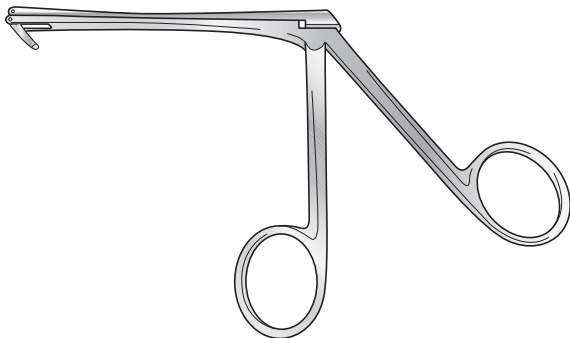

Code	Description
fos-ENT/135	3mm jaw

Mackay Modified Stammberger Punch

200mm long

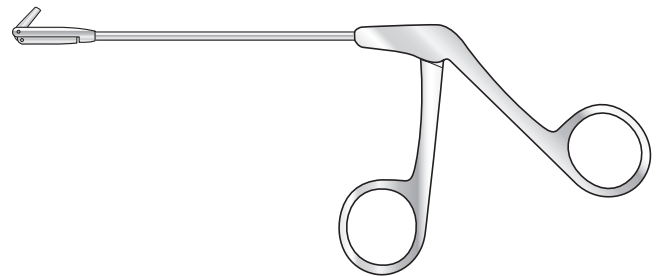

Code	Description
fos-ENT/5392	7 x 2mm jaw

Paterson Biopsy Forceps

Elongated cup, 3mm jaw



Code	Description
fos-ENT/174a	305mm long
fos-ENT/174b	355mm long
fos-ENT/174c	406mm long
fos-ENT/174d	508mm long

Punches

Chevalier Jackson Endoscope Forcep

With crocodile action and serrated jaw

Code	Description
fos-ENT/241	Effective shaft length 300mm
fos-ENT/242	Effective shaft length 400mm
fos-ENT/243	Effective shaft length 500mm
fos-ENT/244	Effective shaft length 600mm

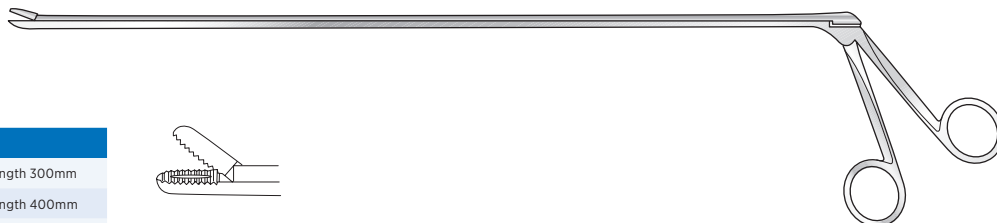
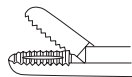

Chevalier Jackson Vocal Nodule Endoscope Forcep

With crocodile action and curved cup

Code	Description
fos-ENT/245	Effective shaft length 300mm
fos-ENT/246	Effective shaft length 400mm
fos-ENT/247	Effective shaft length 500mm
fos-ENT/248	Effective shaft length 600mm

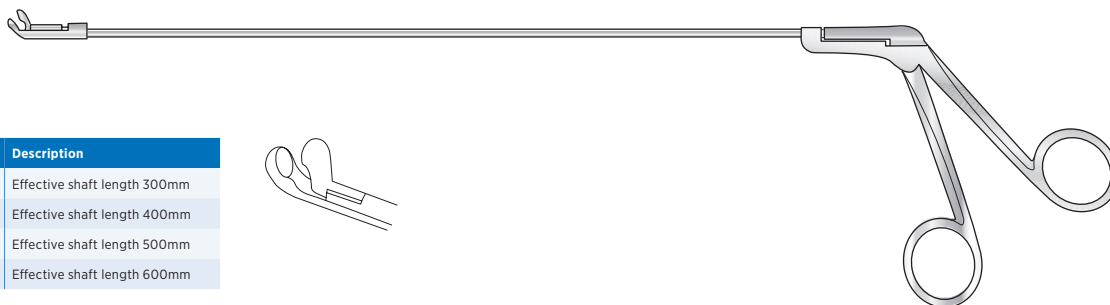
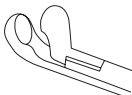

Chevalier Jackson Vocal Nodule Endoscope Forcep

With crocodile action and straight cup

Code	Description
fos-ENT/249	Effective shaft length 300mm
fos-ENT/250	Effective shaft length 400mm
fos-ENT/251	Effective shaft length 500mm
fos-ENT/252	Effective shaft length 600mm



St Bartholomew's Ethmoid Punch

Scoop blades, 3mm bite, 114mm to shoulder

Code	Description
fos-ENT/140a	Straight
fos-ENT/140b	Upward cutting
fos-ENT/140c	Downward cutting

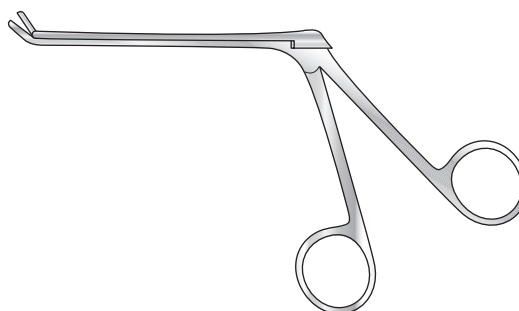

Ferris Smith Kerrison Punch

Heavy, 5mm bite,
229mm long

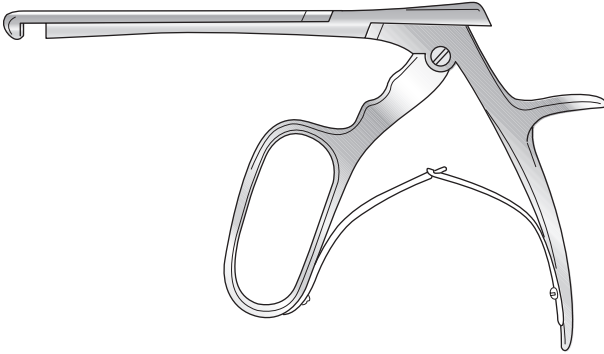

Code	Description
fos-ENT/137a	Upward cutting
fos-ENT/137B	Downward cutting

Citelli Antrum Punch

76mm to shoulder

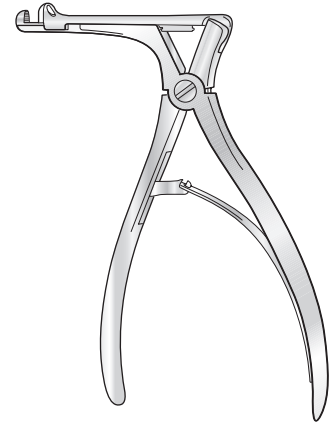

Code	Description
fos-ENT/133a	3mm jaw
fos-ENT/133b	5mm jaw

Hajek Antrum Punch

197mm long

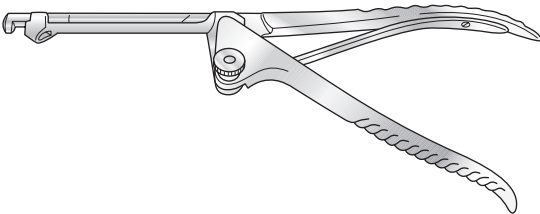

Code	Description
fos-ENT/134	5mm jaw

Hajek Sphenoidal Punch

146mm to shoulder

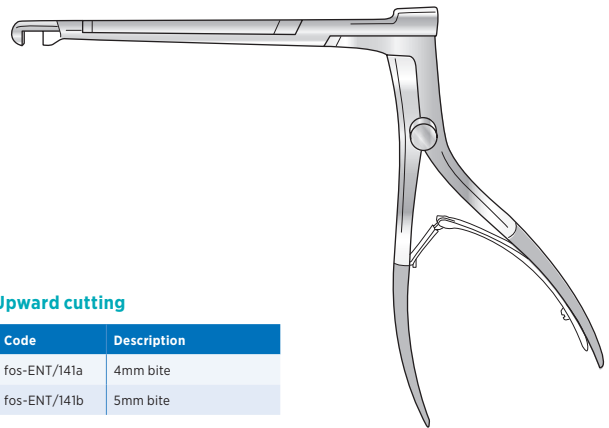

Upward cutting

Code	Description
fos-ENT/141a	4mm bite
fos-ENT/141b	5mm bite

Downward cutting

Code	Description
fos-ENT/141c	4mm bite
fos-ENT/141d	5mm bite

Rongeurs

Beck Rongeur

Straight, for intervertebral disc

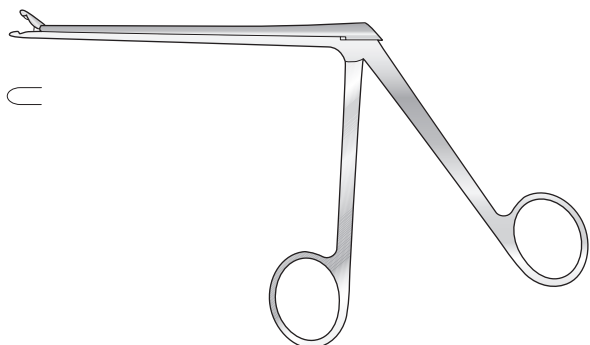

Code	Description
fos-NEU/125	2mm bite, 130mm shaft

Pennybacker Rongeur

120mm shaft

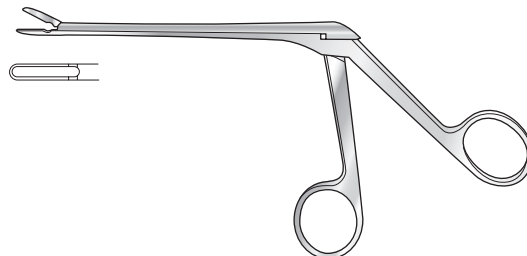

Code	Description
fos-NEU/133	3mm bite
fos-NEU/107	4mm bite

Cushing Rongeur

130mm shaft

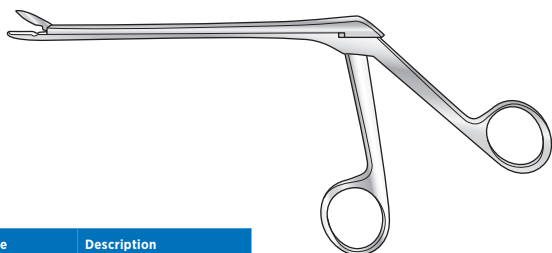

Code	Description
fos-NEU/127-2	2mm bite
fos-NEU/127-3	3mm bite
fos-NEU/127-4	4mm bite
fos-NEU/127-5	5mm bite
fos-NEU/127-6	6mm bite



St Bart's Rongeur

114mm shaft

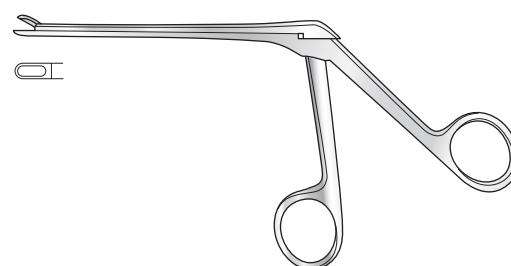

Code	Description
fos-ENT/140a	3mm bite

Cushing Rongeur

130mm shaft

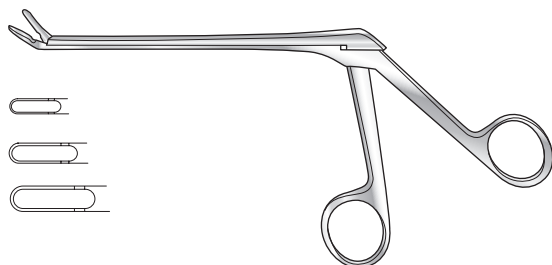

150° upward cutting

Code	Description
fos-NEU/128c	2mm bite
fos-NEU/128	3mm bite
fos-NEU/128a	4mm bite
fos-NEU/128b	5mm bite

150° downward cutting

Code	Description
fos-NEU/130c	2mm bite
fos-NEU/130	3mm bite
fos-NEU/130a	4mm bite
fos-NEU/130b	5mm bite

St Bart's Rongeur

140°, 3mm, 114mm shaft

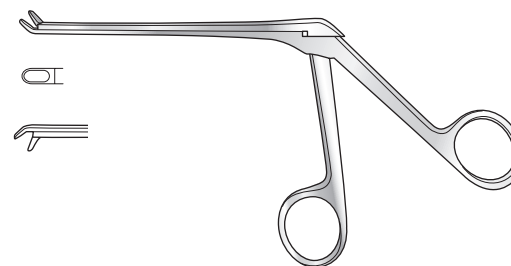

Code	Description
fos-ENT/140b	Upward cutting
fos-ENT/140ac	Downward cutting

Mackay Rongeur

140°, straight, 114mm shaft

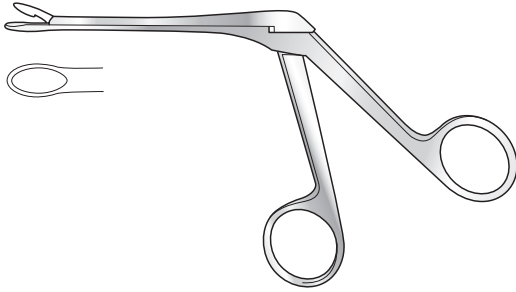

Code	Description
fos-SF#249	5.5mm

Weil-Blakesley Rongeur

110mm shaft

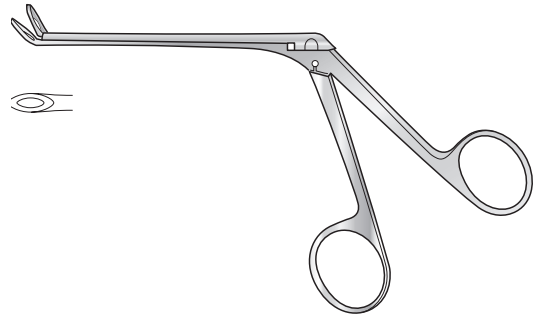

140° upward cutting

Code	Description
fos-ENT/194b	3.6mm bite
fos-ENT/194e	4.2mm bite
fos-ENT/194f	4.8mm bite

140° downward cutting

Code	Description
fos-ENT/194g	3.6mm bite
fos-ENT/194h	4.2mm bite
fos-ENT/194i	4.8mm bite

Mackay Rongeur

With suction tube

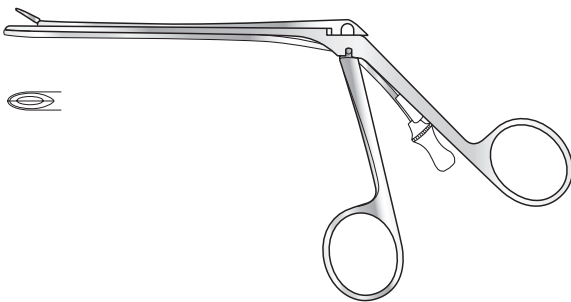

Code	Description
fos-SF#4249a	3.5mm bite, 114mm shaft

Weil-Blakesley Rongeur

120mm shaft

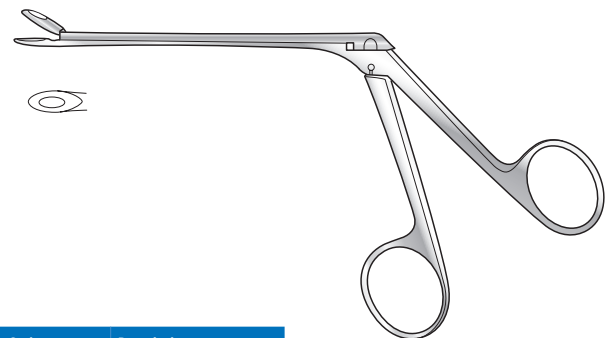

Code	Description
fos-ENT/193b	3.0mm bite
fos-ENT/193	3.6mm bite
fos-ENT/194	4.2mm bite
fos-ENT/194a	4.8mm bite
fos-ENT/194c	5.8mm bite
fos-ENT/194d	6.6mm bite

Mackay Rongeur

With suction tube, 140° upward cutting

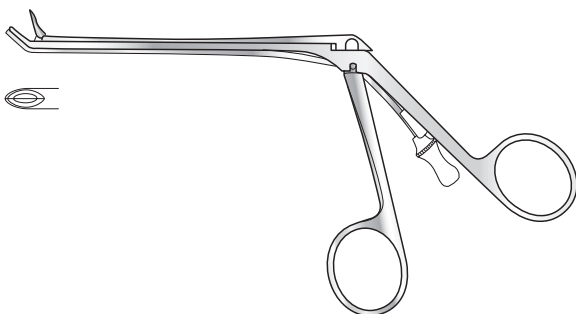

Code	Description
fos-SF#249b	3.5mm bite, 114mm shaft

Scissors

Beckmann Turbinectomy Scissors

Curved



Code	Description
fos-ENT/097	165mm long

Fomon Scissors

Straight, serrated blades, angled handles

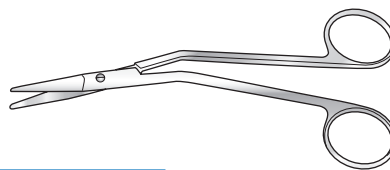

Code	Description
fos-ENT/200	145mm long

Scott Stevenson Tonsil Scissors

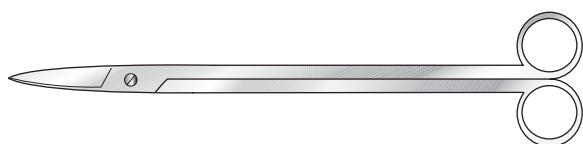

Code	Description
fos-ENT/159	216mm long

Cottle Scissors

Straight blades, angled handles, blunt/blunt

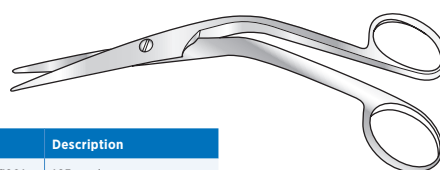

Code	Description
fos-ENT/0201	165mm long

Wood Tonsil Scissors

Sharpened outer edges

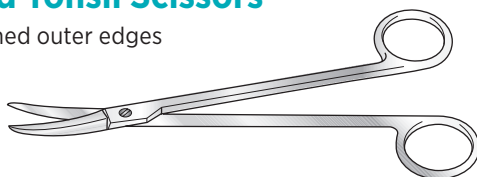

Code	Description
fos-ENT/156	178mm long

Cottle Bulldog Scissors

Blunt/blunt, 115mm long

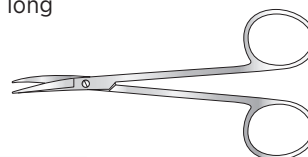

Code	Description
fos-ENT/202	115mm long

Wheeler Tonsil Scissors

Triangular form blades, serrated shanks

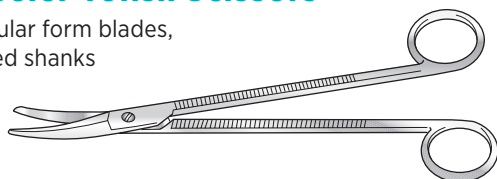

Code	Description
fos-ENT/157	184mm long

Joseph Scissors

Sharp/sharp, 150mm long

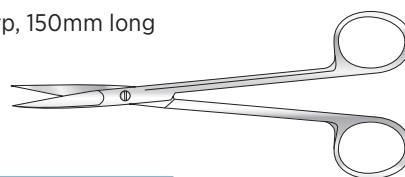

Code	Description
fos-ENT/203	Straight
fos-ENT/204	Curved

Tilley Tonsil Scissors

Curved

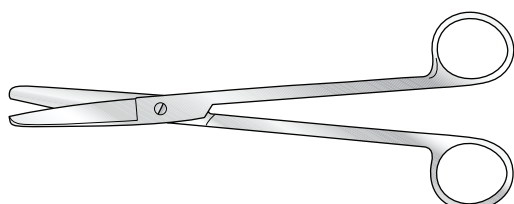

Code	Description
fos-ENT/158	190mm long

Heymann Turbinectomy Scissors

Angular

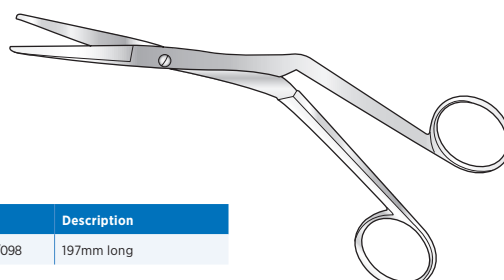

Code	Description
fos-ENT/098	197mm long

Wilson Tonsil Scissors

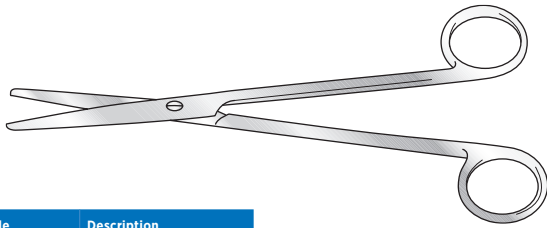

Code	Description
fos-ENT/160	203mm long

Cawthorne Scissors

Micro, extra fine, 70mm to shoulder

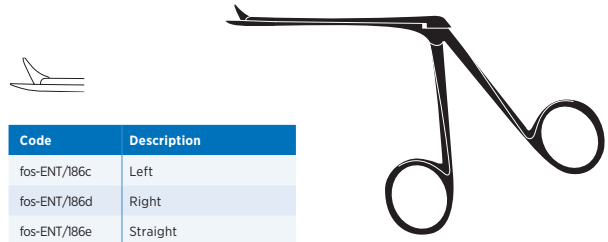

Code	Description
fos-ENT/186c	Left
fos-ENT/186d	Right
fos-ENT/186e	Straight

Thyroid Scissors

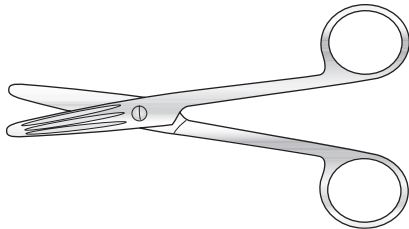

Code	Description
fos-ENT/171	152mm long

Ormorod Aural Scissors

Micro, extra fine, curved upwards

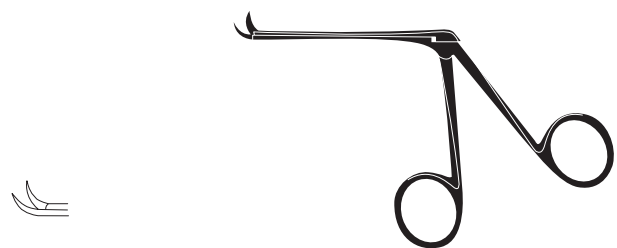

Code	Description
fos-ENT/185	70mm to shoulder

Knapp Scissors

Slight curve, blunt points, 114mm long

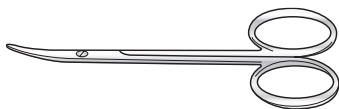

Code	Description
fos-ENT/187a	Satin finish
fos-ENT/187b	Black finish

Portmann Aural Scissors

Micro, satin finish
70mm to shoulder

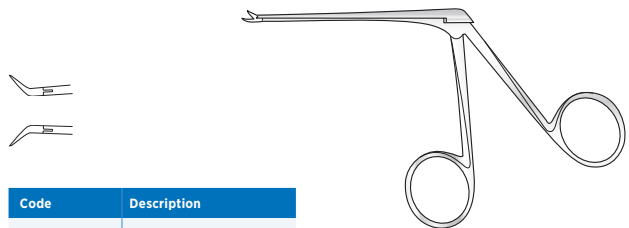

Code	Description
fos-ENT/186a	Curved to right
fos-ENT/186b	Curved to left

Gouges, Knives and Elevators

Ballenger Nasal Cartilage Knife

Revolving blade

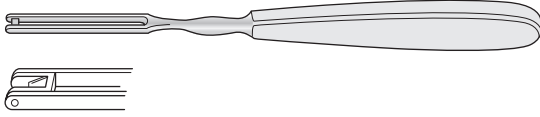

Straight, 203mm long

Code	Description
fos-ENT/096a	6mm wide
fos-ENT/096b	8mm wide

Cranked, 197mm long

Code	Description
fos-ENT/096c	6mm wide

Sickle Knife



Code	Description
fos-BRS002	188mm long
fos-ENT/271	160mm long

Jenkins Gouge

140mm long



Code	Description	Code	Description
fos-ENT/037	1mm	fos-ENT/037g	8mm
fos-ENT/037a	2mm	fos-ENT/037h	9mm
fos-ENT/037b	3mm	fos-ENT/037i	10mm
fos-ENT/037c	4mm	fos-ENT/037j	11mm
fos-ENT/037d	5mm	fos-ENT/037k	12mm
fos-ENT/037e	6mm	fos-ENT/037l	13mm
fos-ENT/037f	7mm	fos-ENT/037m	14mm

Killian Nasal Gouge

127mm long



Code	Description
fos-ENT/093	4mm

Guy's Hospital Nasal Gouge

Shallow groove and flattened back, 127mm long



Code	Description
fos-ENT/094	4mm

Tilley Nasal Gouge

V shaped, 127mm long



Code	Description
fos-ENT/095	4mm

Cottle Elevator

Double ended, black chrome finish
200mm long



Code
fos-ENT/224

Hill Elevator

Double ended, curved to side, rugine end



Code	Description
fos-ENT/091	5mm wide, 222mm long

Tumarkin Atticotomy Elevator

Double ended



Code	Description
fos-ENT/036	191mm long

Buck Ear Curette

Angled, blunt, 146mm long

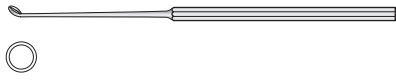

Code	Description
fos-ENT/028	2mm
fos-ENT/028a	2.5mm
fos-ENT/028b	3mm
fos-ENT/028c	3.5mm
fos-ENT/028d	4mm

Nasal Curette

Straight, 185mm long



Code	Description
fos-ENT/628702	5 x 2mm

Beckmann Adenoid Curette

216mm long

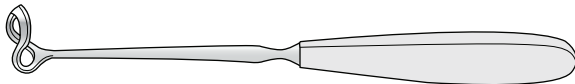

Code	Description
fos-ENT/167a	8mm blade
fos-ENT/167b	10mm blade
fos-ENT/167c	12mm blade
fos-ENT/167d	14mm blade
fos-ENT/167e	16mm blade
fos-ENT/167f	18mm blade

Agnew (Poltzer) Myringotome

190mm long

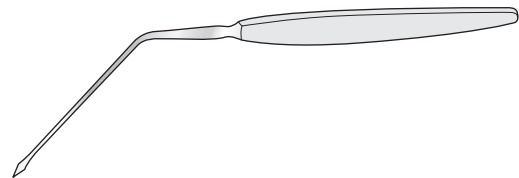

Code	Description
fos-ENT/031	Shaft length 100mm

Trautmann Myringotome

178mm long



Code	Description
fos-ENT/032	Upward cutting
fos-ENT/033	Downward cutting

St Clair Thomson Adenoid Curette

With cage, 235mm long

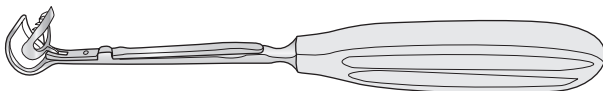

Code	Description
fos-ENT/168a	8mm
fos-ENT/168b	10mm
fos-ENT/168c	12mm
fos-ENT/168d	14mm
fos-ENT/168e	16mm
fos-ENT/168f	18mm

Elevators and Dissectors

Freer Instruments

Single ended, 190mm long

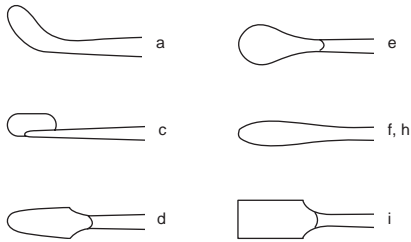

Knife

Code	Description
fos-ENT/065a	Curved to side
fos-ENT/065c	Rounded edge, 8mm blade
fos-ENT/065d	Flat rounded blade
fos-ENT/065e	Rounded blade, curved on flat

Elevator

Code	Description
fos-ENT/065f	Dull edged
fos-ENT/065h	Sharp edged

Chisel

Code
fos-ENT/065i

Freer Separator and Elevator

Double ended

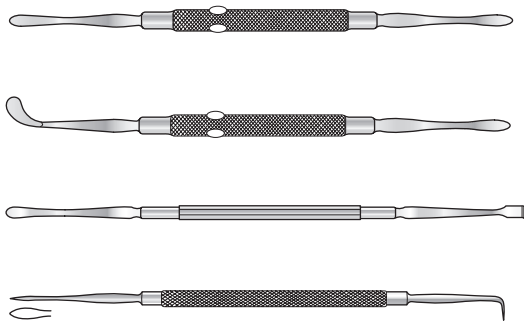

Code	Description
fos-ENT/065b	Blunt/sharp, 180mm long
fos-ENT/065g	Sharp, knife curved to side, 180mm long
fos-ENT/065j	Blunt/sharp, 200mm long
fos-ENT/065j-sal	Blunt/sharp, 188mm long

St Clair Thompson Dissector

159mm



Code	Description
fos-ENT/089a	Sharp
fos-ENT/089b	Blunt

Negus Aspiring Dissector

With 6mm olive, 210mm long



Code	Description
fos-ENT/090a	-
fos-ENT/090b	Insulated

Syme Tonsil Dissector

Double ended, one end blunt, one semi sharp



Code	Description
fos-ENT/149	170mm long

Gwynne-Evans Tonsil Dissector

Double ended, with serrated end and blunt end
197mm long



Code	Description
fos-ENT/146a	6mm wide
fos-ENT/146b	8mm wide

Woakes Eustachian Catheters

Silver, Luer, 140mm



Code	Description
fos-ENT/015	7 F.G.
fos-ENT/015a	8 F.G.
fos-ENT/015b	9 F.G.

Code	Description
fos-ENT/015c	10 F.G.
fos-ENT/015d	11 F.G.

Kramer Eustachian Catheters

Silver, Luer, 140mm

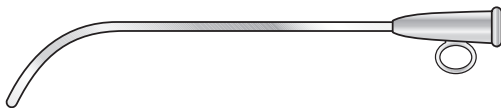

Code	Description
fos-ENT/014	7 F.G.
fos-ENT/014a	8 F.G.
fos-ENT/014b	9 F.G.

Code	Description
fos-ENT/014c	10 F.G.
fos-ENT/014d	11 F.G.

Myles Naso-Antral Perforator

171mm long

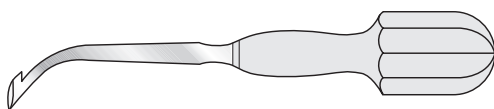

Code	Description
fos-ENT/103a	16 F.G.
fos-ENT/103b	19 F.G.

Tilley Antrum Burrs

171mm long

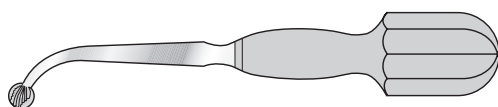

Code	Description
fos-ENT/131a	6mm ø
fos-ENT/131b	7mm ø
fos-ENT/131c	8mm ø

Laryngeal Mirror

Mirror only, 130mm long

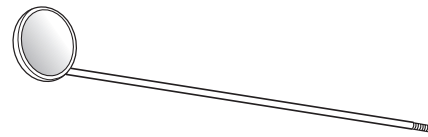

Code	Description
fos-ENT/191-6	6mm ø
fos-ENT/191-8	8mm ø
fos-ENT/191-10	10mm ø
fos-ENT/191-12	12mm ø
fos-ENT/191-14	14mm ø
fos-ENT/191-16	16mm ø
fos-ENT/191-18	18mm ø

Code	Description
fos-ENT/191-20	20mm ø
fos-ENT/191-22	22mm ø
fos-ENT/191-24	24mm ø
fos-ENT/191-26	26mm ø
fos-ENT/191-28	28mm ø
fos-ENT/191-30	30mm ø

Laryngeal Mirror

Complete with metal handle, 260mm long

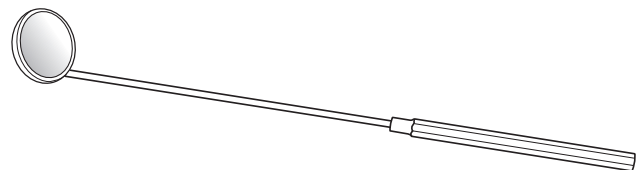

Code	Description
fos-ENT/192-6	6mm ø
fos-ENT/192-8	8mm ø
fos-ENT/192-10	10mm ø
fos-ENT/192-12	12mm ø
fos-ENT/192-14	14mm ø
fos-ENT/192-16	16mm ø
fos-ENT/192-18	18mm ø

Code	Description
fos-ENT/192-20	20mm ø
fos-ENT/192-22	22mm ø
fos-ENT/192-24	24mm ø
fos-ENT/192-26	26mm ø
fos-ENT/192-28	28mm ø
fos-ENT/192-30	30mm ø

Mitchell Trimmer



Code	Description
fos-ENT/013	165mm

Miscellaneous

Lake Seeker

Double ended, for vestibule



Code	Description
fos-ENT/040	184mm long

Negus Pusher

“Knot tier”, metal handle



Code	Description
fos-ENT/165	203mm long

Lempert Rugine

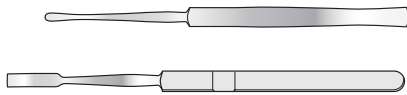

Code	Description
fos-ENT/064a	Narrow, 156mm long
fos-ENT/065a	Broad, 171mm long

Stanford Cade Insufflator

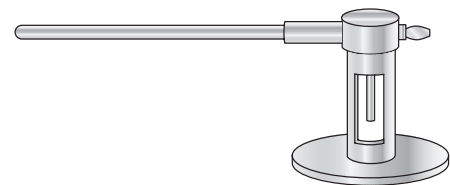

Code	Description
fos-ENT/188	175mm long

Irwin-Moore Tonsil Needle

203mm long



Code	Description
fos-ENT/164a	Curved to right
fos-ENT/164a	Curved to left

Tubing Mount

For use with catheters, Luer



Code	Description
fos-ENT/016	25mm

Gynaecology

Clamps	90
Forceps	90
Biopsy Forceps	94
Cervical Forceps	97
Obstetric Forceps	98
Speculum	99
Retractors	101
Curettes	103
Catheters	104
Scissors	106
Miscellaneous	107
Dilators and Sounds	108

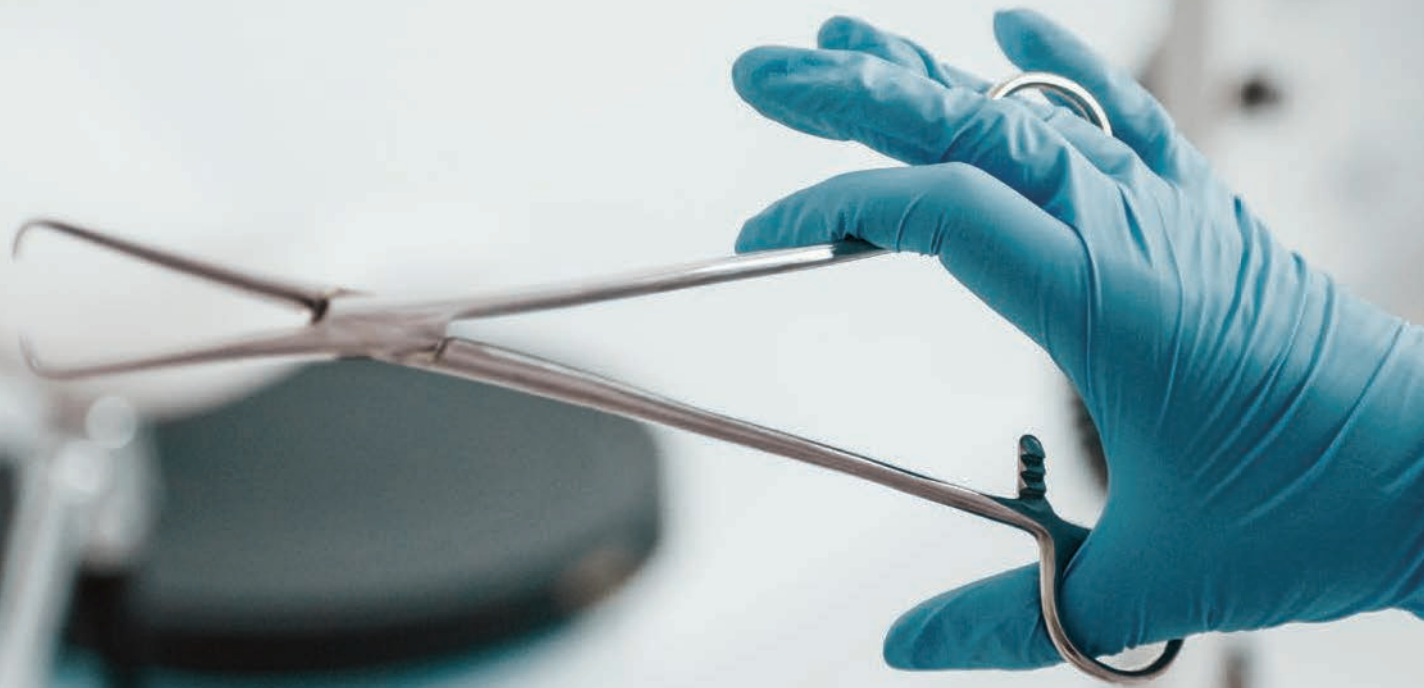

Clamps and Forceps

Parametrium Clamp Forceps

Hysterectomy clamp, atraumatic jaws, two gold bows

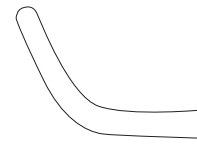
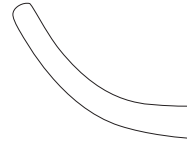
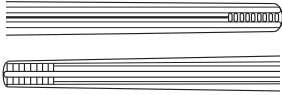
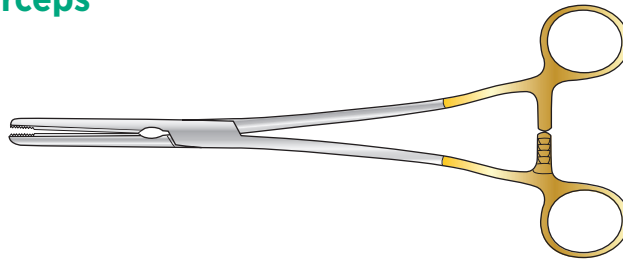

Straight

Code	Description
fos-GY/078	203mm long
fos-GY/078a	233mm long
fos-GY/078b	254mm long
fos-GY/078c	304mm long
fos-GY/078d	360mm long

Slight curve

Code	Description
fos-GY/078e	203mm long
fos-GY/078f	233mm long
fos-GY/078g	254mm long
fos-GY/078h	304mm long
fos-GY/078i	360mm long

Strong curve

Code	Description
fos-GY/078j	203mm long
fos-GY/078k	233mm long
fos-GY/078L	254mm long
fos-GY/078n	360mm long

Angled

Code	Description
fos-GY/078o	203mm long
fos-GY/078p	233mm long
fos-GY/078q	254mm long
fos-GY/078r	304mm long
fos-GY/078s	360mm long

Spencer-Robarts Clamp

For endometrial and pedunculated fibroid polyps, with ratchet jaw-locking mechanism, and 50° jaw opening

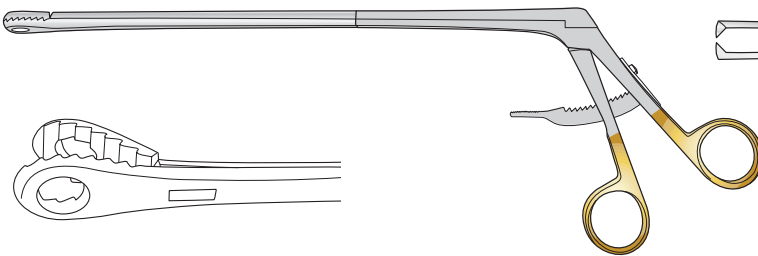

Code	Description
fos-GY/082	Shaft 235mm long

Museux Vulsellum Forceps

Matt finish

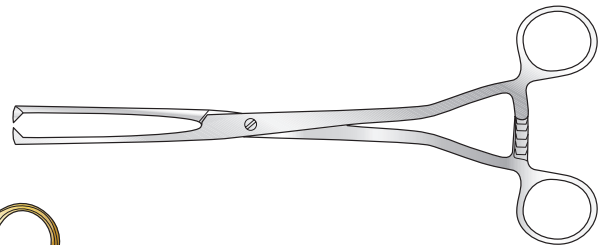

Code	Description
fos-GY/123	240mm long



Schroeder Uterine Vulsellum Forcep

1-1 teeth

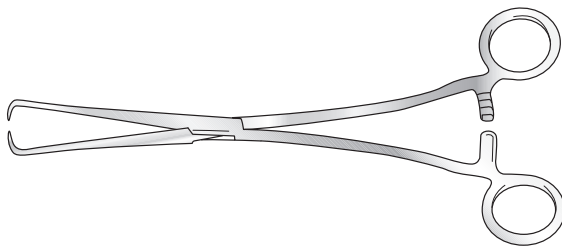

Code	Description
fos-GY/022	229mm long

Teale Uterine Vulsellum Forcep

3-4 teeth, 230mm long

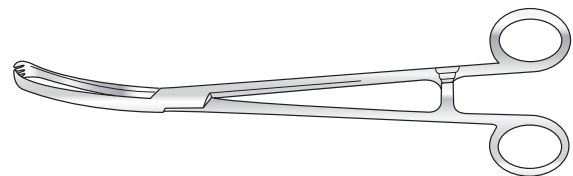

Code	Description
fos-GY/023	Curved
fos-GY/023a	Straight

Bonney Hysterectomy Forceps

Angled on flat, 1 - 2 teeth

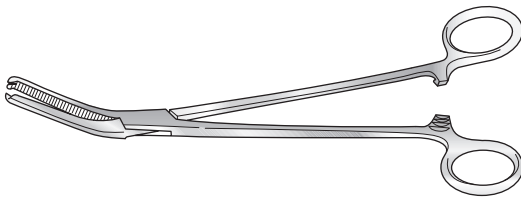

Code	Description
fos-GY/018	197mm long

Maingot Hysterectomy Forceps

203mm long

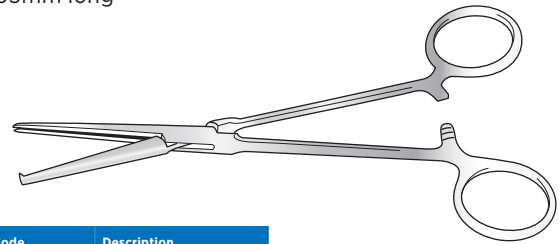

Code	Description
fos-GY/017a	Curved on flat, 1 - 2 teeth
fos-GY/017b	Straight

Berkeley-Bonney Hysterectomy Forceps

Curved on flat, 1 - 2 teeth

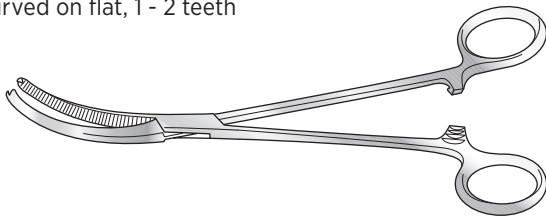

Code	Description
fos-GY/019	203mm long

Faures Peritoneum Forceps

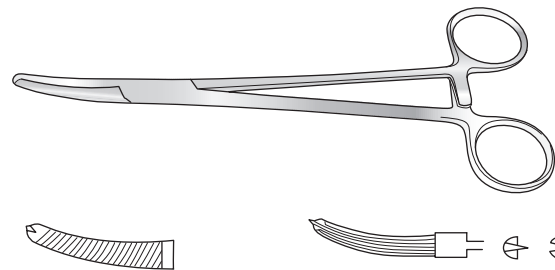

205mm long

Code	Description
fos-GY/146	Slight curve

203mm long,
longitudinal serrations

Code	Description
fos-GY/5146	Curved, toothed
fos-GY/5146a	Curved

Gwilliam Hysterectomy Forceps

Longitudinal serrations
203mm long

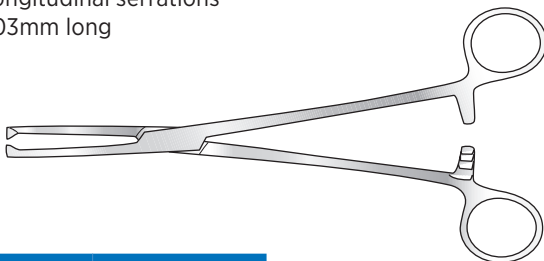

Code	Description
fos-GY/003a	Straight,
fos-GY/003b	Curved on flat, 1-2 teeth

Heaney Hysterectomy Forceps

Curved on flat, 203mm long

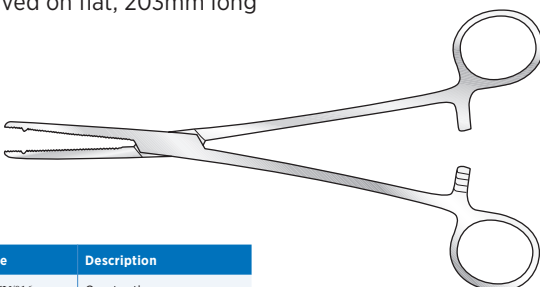

Code	Description
fos-GY/016a	One tooth
fos-GY/016b	Double tooth

Forceps

Bonney Uterine Polypus Forcep

Box joint

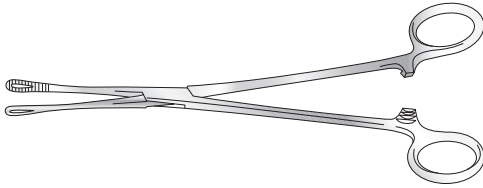

Code	Description
fos-GY/020	240mm long

Somer Uturus Holding Forcep

Matt finish

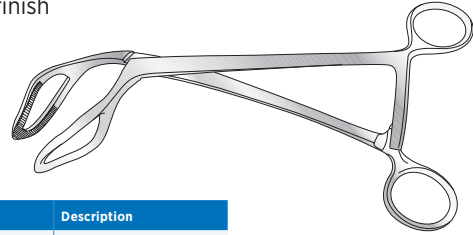

Code	Description
fos-GY/091	230mm long
fos-GY/002	254mm long

Noto Uterine Polypus Forceps

Matt finish

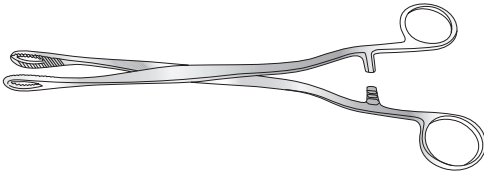

Code	Description
fos-GY/124	240mm long

McClintock Ovum Forcep

Curved, screw joint



Code	Description
fos-GY/036	241mm long

Vant Uterine Polypus Forcep

Serrated

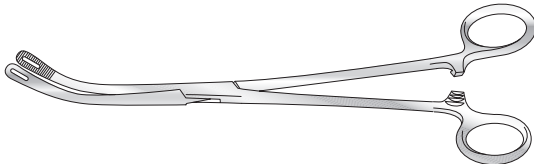

Code	Description
fos-GY/021	240mm long

Greenhalgh Ovum Forcep

Screw joint

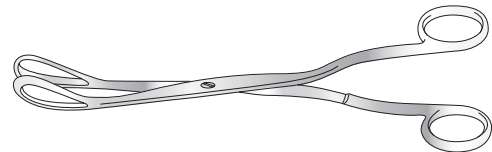

Code	Description
fos-GY/037	240mm long

Dartigues Uterine Forceps

Matt finish

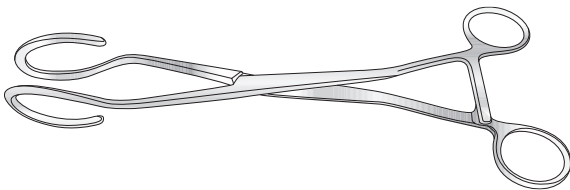

Code	Description
fos-GY/090	270mm long

Keily Ovum Forceps

Matt finish

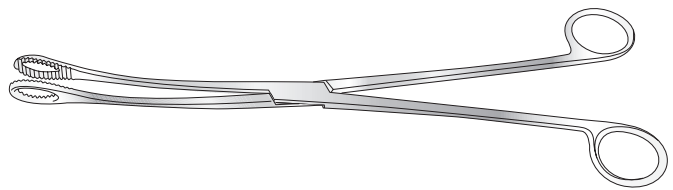

Code	Description
fos-GY/111	320mm long

Doyen Ovarian Forceps

Matt finish

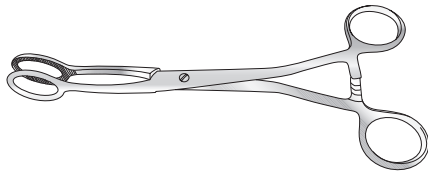

Code	Description
fos-GY/118	210mm long

Lowa Tenaculum Forceps

Matt finish, 5-6 teeth

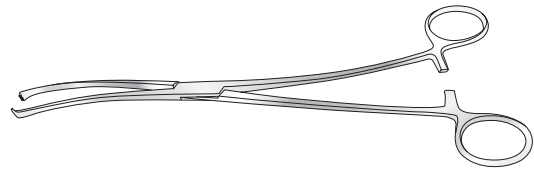

Code	Description
fos-GY/094	260mm long



Wertheim Parametrium Forcep

Curved on flat, screw joint

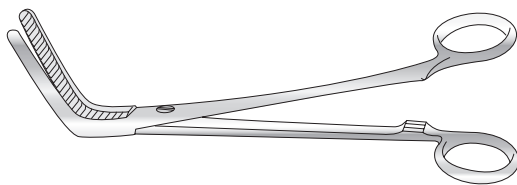

Code	Description
fos-GY/005	254mm long

Skene Tenaculum Forceps

Bright finish

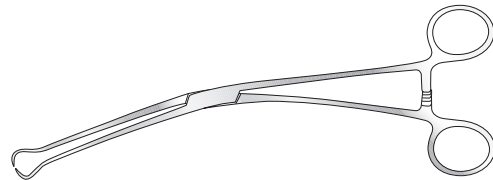

Code	Description
fos-GY/120	240mm long

Green-Armytage Haemostasis Forcep

Screw joint, 15mm jaw, 210mm long

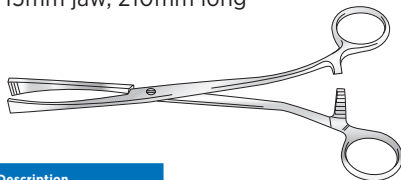

Code	Description
fos-GY/029a	Straight
fos-GY/029b	Angled

Pratt Tenaculum Forceps

Matt finish

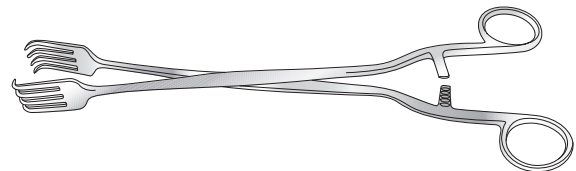

Code	Description
fos-GY/095	280mm long

Kogan Endocervical Forceps

Matt finish, 275mm long

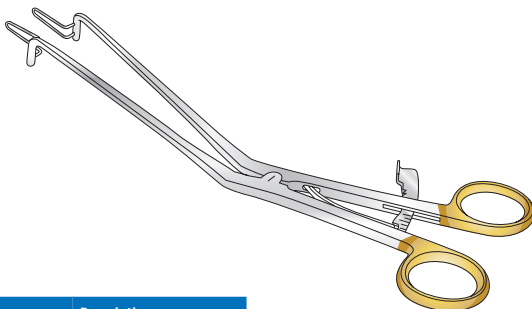

Code	Description
fos-GY/131	3mm jaw
fos-GY/131a	5mm jaw
fos-GY/131b	7mm jaw

Coil Removing Forcep

With serrated rounded jaws
4mm wide

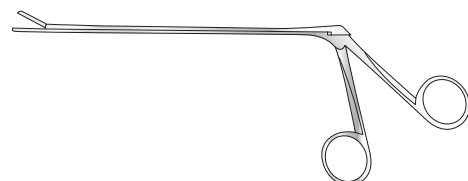

Code	Description
fos-GY/075	160mm to shoulder

Forceps and Biopsy Forceps

Willet Martel Forceps

Matt finish

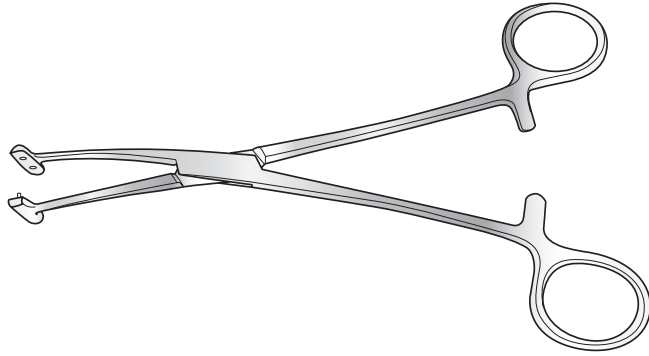

Code	Description
fos-GY/121	190mm long



Littlewood Tissue Forceps

2-3 teeth, matt finish

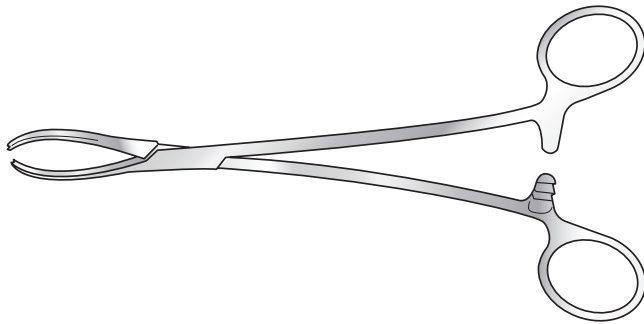

Code	Description
fos-GY/275	190mm long

Eppendorf Biopsy Punch Forcep

200mm to shoulder

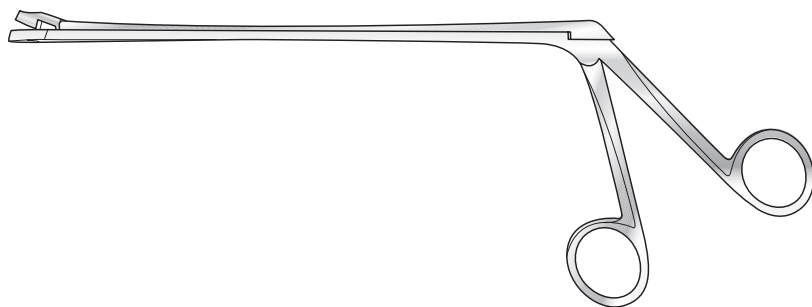

 Bite shown actual size

Code	Description
fos-GY/14-314-200	3mm x 8mm bite

Kevorkian Biopsy Punch Forcep

255mm to shoulder

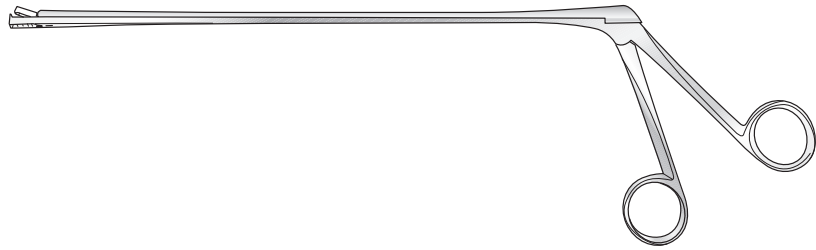

Bite shown actual size

Code	Description
fos-GY/14-329-250	3mm x 8mm bite

Tischler Morgan Biopsy Forcep

210mm to shoulder

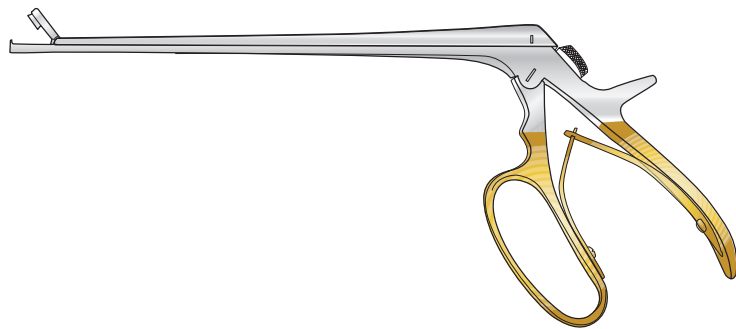

Bite shown actual size

Code	Description
fos-GY/14-328-220	3mm x 7mm bite

Tischler Morgan Biopsy Punch Forcep

295mm to shoulder

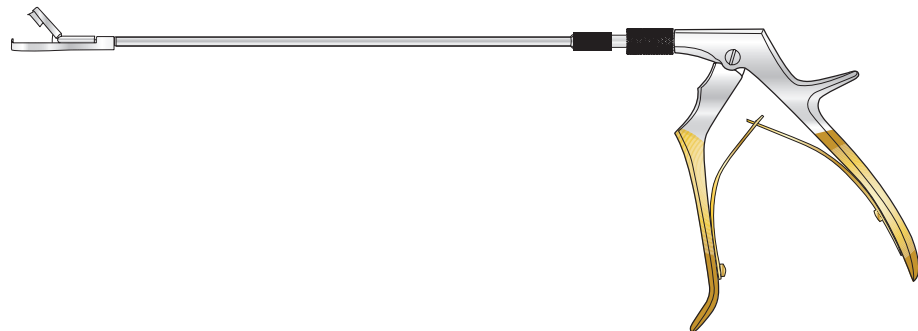

Bite shown actual size

Code	Description
fos-GY/088	2mm x 7mm bite

Biopsy Forceps

Baby Tischler Biopsy Forcep

210mm to shoulder

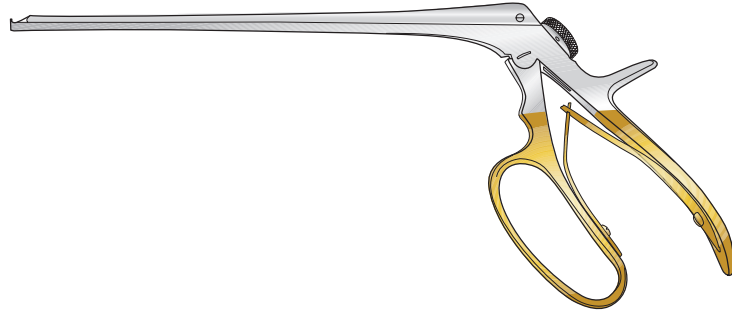



 Bite shown actual size

Code	Description
fos-GY/14-325-250	2mm x 5mm bite

Baby Tischler Biopsy Punch Forcep

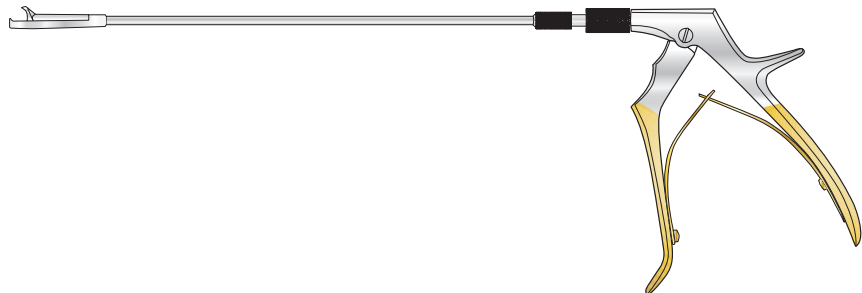
295mm to shoulder





 Bite shown actual size

Code	Description
fos-GY/087	2mm x 5mm bite

Van Doren Biopsy Forceps

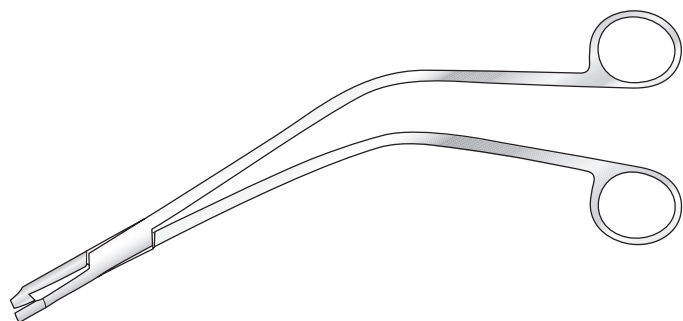
Bright finish, 260mm overall length



 Bite shown actual size

Code	Description
fos-GY/112	5mm x 9mm bite

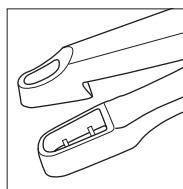

Van Doren Cervical Biopsy Punch Forcep

With curved basket jaw, angled shanks

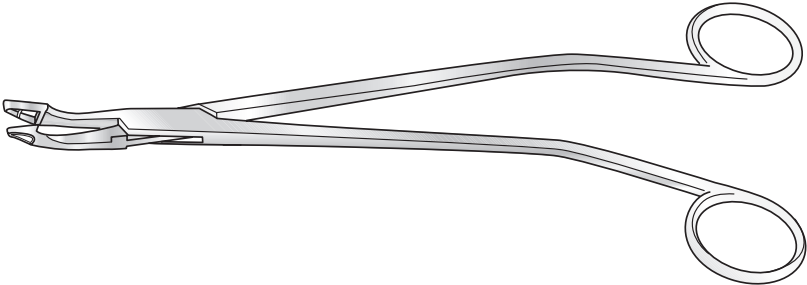

Code	Description
fos-GY.025	240mm long

Wittner Cervical Biopsy Punch Forcep

240mm long shaft



Code	Description
fos-GY.024a	Jaws curved to side
fos-GY.024b	Jaws straight to side

Obstetric Forceps

Barnes Obstetric Forcep

With Simpson handles and Neville axis traction rod

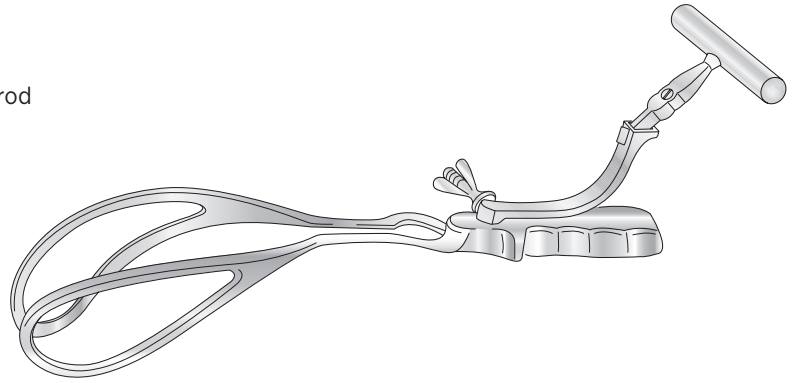

Code	Description
fos-GY/027	381mm long

Haig Ferguson Obstetric Forcep

Tape slots in blades and axis traction rod

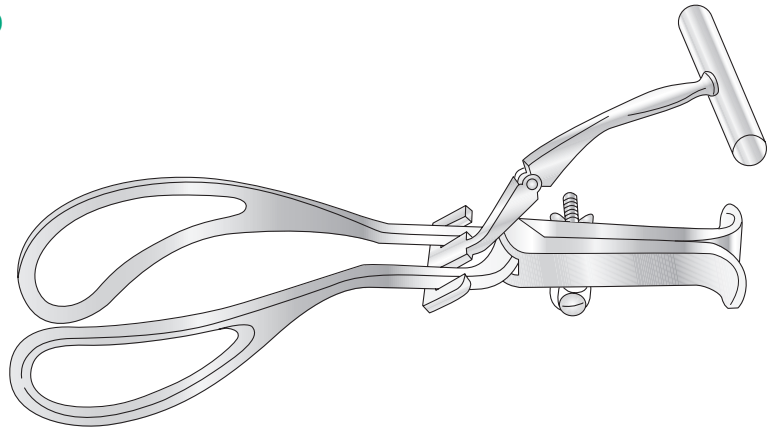

Code	Description
fos-GY/028	356mm long

Kieland Obstetric Forcep

Matt finish

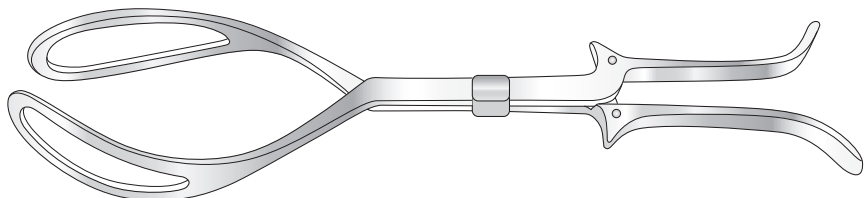

Code	Description
fos-GY/089	410mm long

Simpson Braun Obstetric Forcep

Matt finish

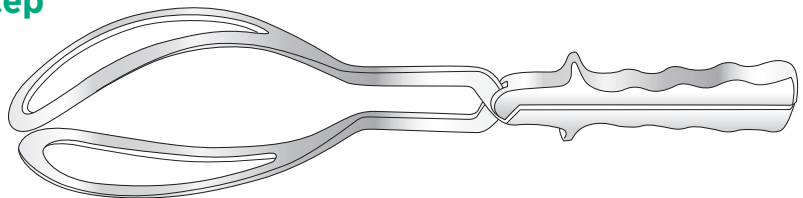

Code	Description
fos-GY/086	380mm long

Wrigley Obstetric Forcep

Short model for caesarian section

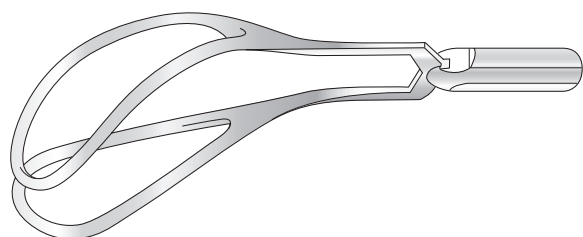

Code	Description
fos-GY/026	279mm long

Auvard Vaginal Speculum

Weighted

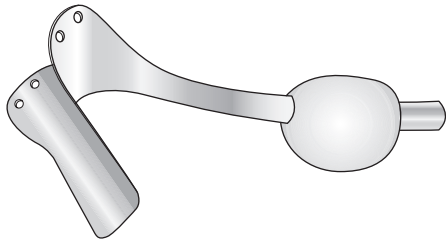

Code	Description
fos-GY/007a	Small blade 38 x 90mm
fos-GY/007b	Large blade 51 x 90mm

Collin Vaginal Speculum

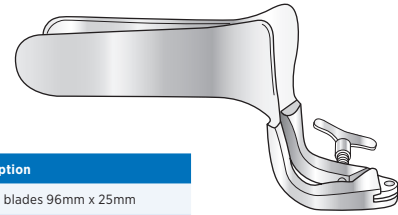

Code	Description
fos-GY/014a	Small - blades 96mm x 25mm
fos-GY/014b	Medium - blades 108mm x 30mm
fos-GY/014c	Large - blades 108mm x 35mm

Nott Speculum

Stainless steel

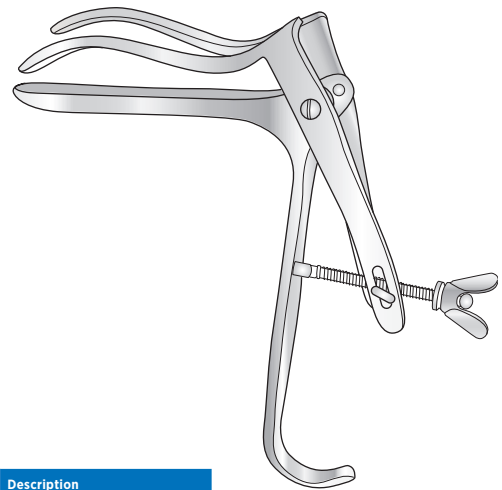

Code	Description
fos-GY/04102	Blade 110mm long, 30mm wide

Graves Vaginal Speculum

Bright finish



Code	Description
fos-GY/103	115 x 35mm

Cusco Vaginal Speculum

Stainless steel

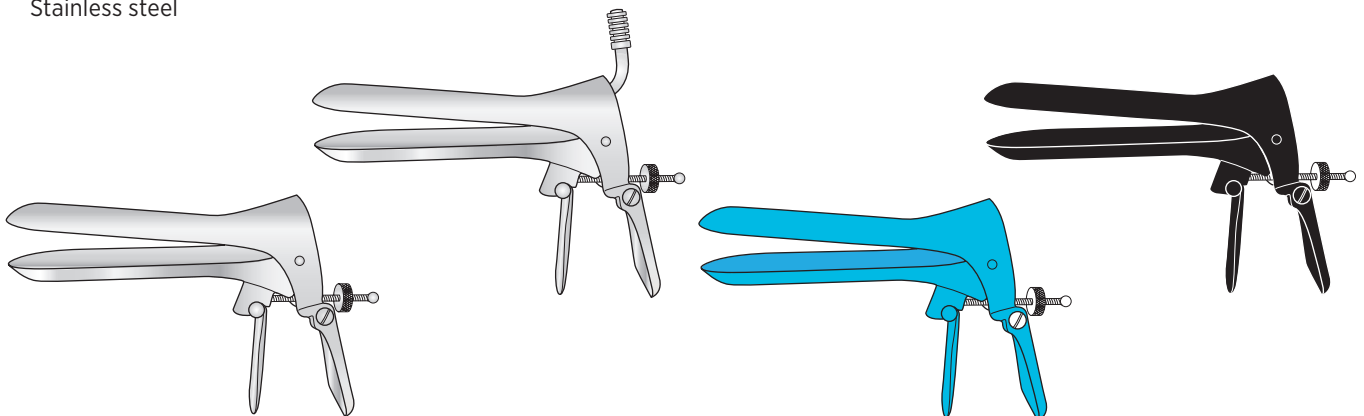

Insulated

Code	Description
fos-GY/015d	Extra small - 98mm x 16mm
fos-GY/015c	Small - 105mm x 25mm
fos-GY/015f	Medium - 107mm x 29mm
fos-GY/015e	Large - 115mm x 35mm

Code	Description
fos-GY/134	Small - 105mm x 25mm
fos-GY/135	Medium - 107mm x 29mm
fos-GY/136	Large - 115mm x 35mm
fos-GY/137	Extra large - 135mm x 38mm

With Suction Tube

Code	Description
fos-GY/015k	Small - 105mm x 25mm
fos-GY/015j	Medium - 107mm x 29mm
fos-GY/015i	Large - 115mm x 35mm
fos-GY/015h	Extra large - 135mm x 38mm

Black Finish

Code	Description
fos-GY/138	Small - 105mm x 25mm
fos-GY/139	Medium - 107mm x 29mm
fos-GY/140	Large - 115mm x 35mm
fos-GY/141	Extra large - 135mm x 38mm

Speculum

Pederson Vaginal Speculum

Stainless steel

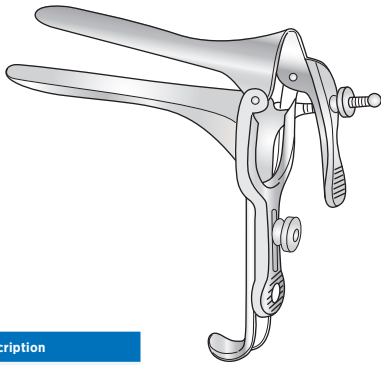

Code	Description
fos-GY/078	120mm x 25mm wide
fos-GY/078a	90mm x 20mm wide

Winterton Vaginal Speculum

Stainless steel

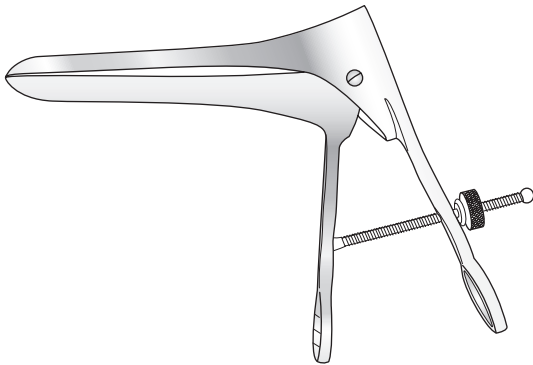

Code	Description
fos-GY/074	Blade 115mm long, 25mm wide

Modified Speculum

Stainless steel, for elderly patients

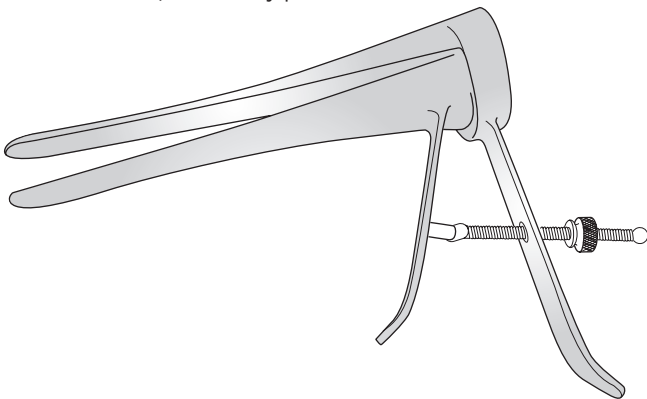

Code	Description
fos-GY/074a	Blade 180mm long, 18mm wide

Sims Duckbill Speculum

Double ended

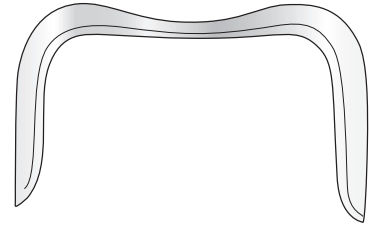

Code	Description
fos-GY/012a	Small - 27mm x 29mm x 130mm long
fos-GY/012b	Medium - 30mm x 33mm x 158mm long
fos-GY/012c	Large - 33mm x 38mm x 184mm long

Sims Duckbill Speculum

Double ended,
insulated

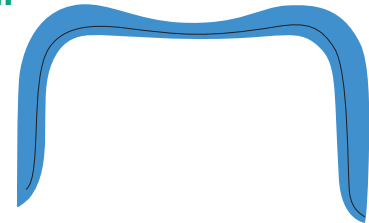

Code	Description
fos-DIA/031	Small - 27mm x 29mm x 130mm long
fos-DIA/032	Medium - 30mm x 33mm x 158mm long
fos-DIA/033	Large - 33mm x 38mm x 184mm long

Breisky Vaginal Retractor

Bright finish, matt handle
320mm long

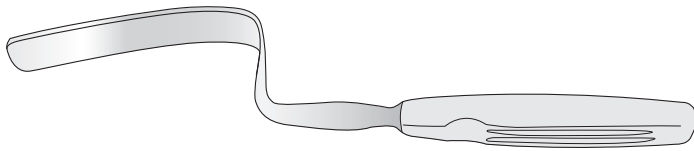

Code	Description
fos-GY/110	25mm blade

Doyen Retractor

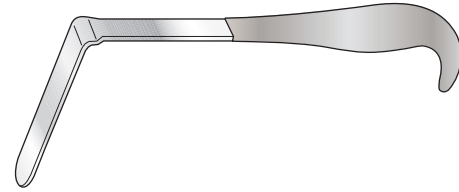

Code	Description
fos-GY/009b	Blade 100mm x 30mm

Doyen Rectangular Retractor

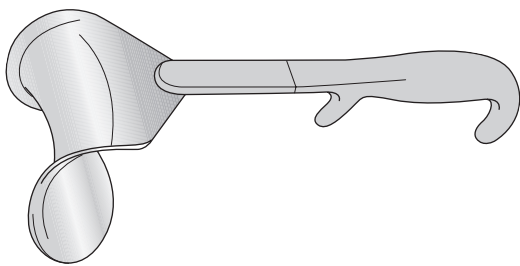

Code	Description
fos-GY/008a	Small - 48 x 60mm
fos-GY/008b	Medium - 48 x 89mm
fos-GY/008c	Large - 48 x 124mm

St Mark's Hospital Pattern Retractor

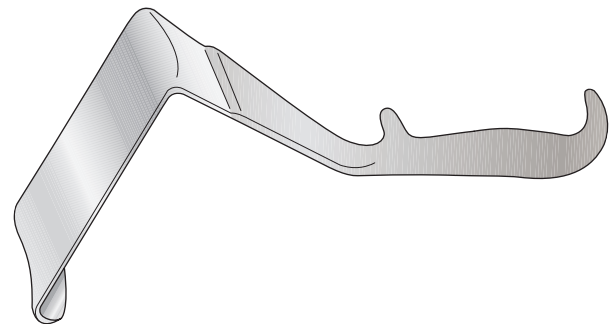

With lip

Code	Description
fos-GY/065	Blade 125mm x 60mm
fos-GY/066	Blade 175mm x 60mm

Without lip

Code	Description
fos-GY/067	Blade 125mm x 60mm
fos-GY/068	Blade 175mm x 60mm

Doyen Retractor

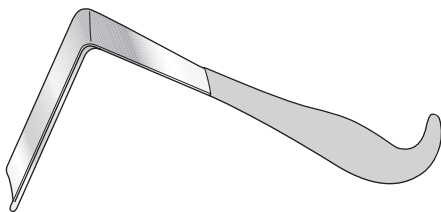

Code	Description
fos-GY/009a	Blade 95mm x 27mm

Wertheim Retractor

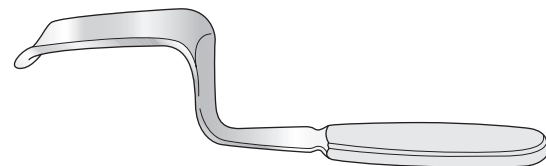

Code	Description
fos-GY/010	Blade 95mm x 38mm

Retractors

Landon Vaginal Retractor

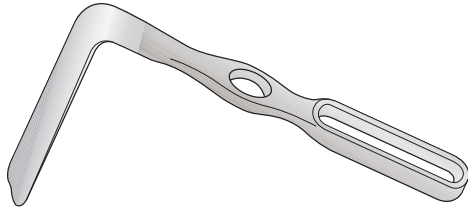

Code	Description
fos-GY/011	Blade 89mm x 25mm

Lateral Vaginal Retractor

Blades bright finish, matt handle

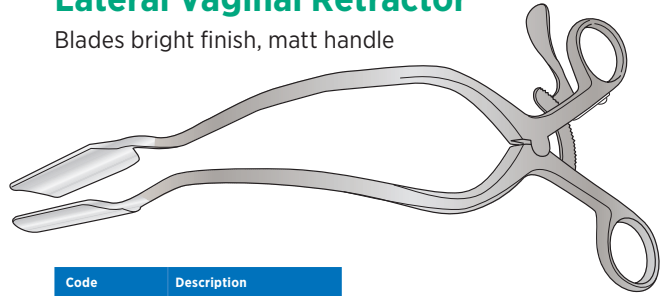

Code	Description
fos-GY/128	60 x 20mm blade
fos-GY/128a	75 x 22mm blade
fos-GY/128b	110 x 23mm blade

AVAILABLE INSULATED
ADD SUFFIX 'INS'

Whitlow Retractor

Vaginal retractor, for use with supplied blades. Points of retraction move around almost 360°. Supplied complete with sterilising basket and three sets of blades.

Frame

225mm at widest point

Blades

1 x anterior and 1 x posterior 90°, 25mm x 100mm
2 x lateral 90°, 25mm x 70mm
2 x lateral 75°, 25mm x 70mm

Code
fos-GY/084

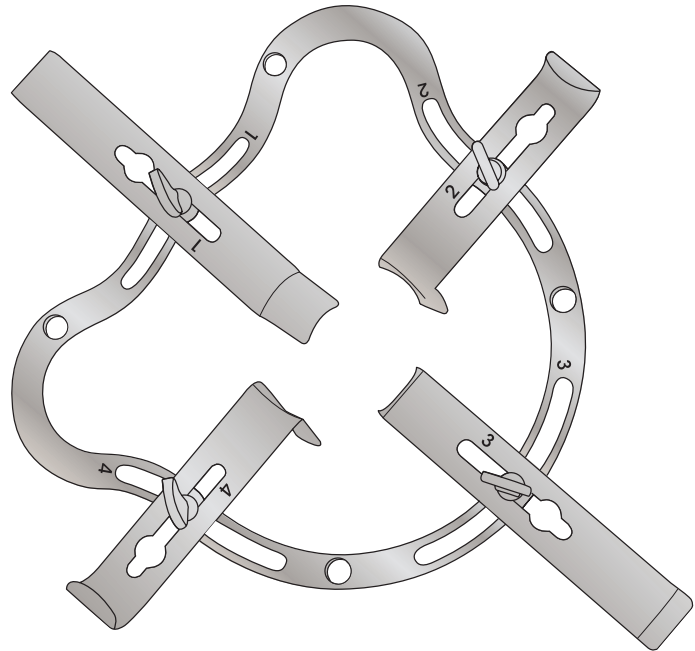
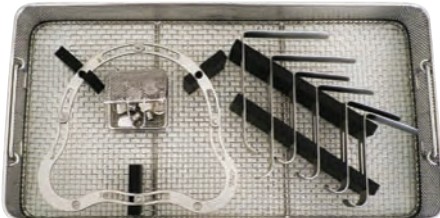

Kevorkian Biopsy Curette

313mm long

Code	Description
fos-GY/105	With basket
fos-GY/127	Without basket



Novak Curette

Code	Description
fos-GY/119	230mm long



Recamier Uterine Curette

Matt finish, 310mm long

Code	Description
fos-GY/108	Blunt
fos-GY/109	Sharp



Rheinstadter Flushing Curette

290mm long

Sharp

Code	Description
fos-GY/076a	Sharp, 8mm
fos-GY/076b	Sharp, 14mm

Blunt

Code	Description
fos-GY/076c	Blunt, 8mm
fos-GY/076d	Blunt, 14mm



Sims Uterine Curette

Single ended, 255mm long, matt finish

Sharp

Code	Description
fos-GY/075a	Small 6mm
fos-GY/075b	Medium 10mm
fos-GY/075c	Large 13mm

Blunt

Code	Description
fos-GY/075d	Small 6mm
fos-GY/075e	Medium 10mm
fos-GY/075f	Large 13mm



Sims Uterine Curette

Double ended, 250mm long

Sharp

Code	Description
fos-GY/044	Small 7 x 5mm
fos-GY/045	Medium 10 x 7mm
fos-GY/046	Large 13 x 10mm

Blunt

Code	Description
fos-GY/047	Small 7 x 5mm
fos-GY/048	Medium 10 x 7mm
fos-GY/049	Large 13 x 10mm



Catheters

Rotunda Hospital Pattern Catheter

With solid end, chromium plated, 203mm long

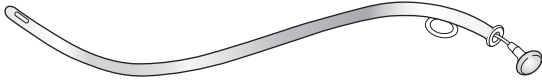

Code	Description
fos-GY/035a	8 E.G.
fos-GY/035b	10 E.G.

Catheter

Oval, solid end, chromium plated



Code	Description
fos-GY/034	165mm long

Catheter Introducer

457mm long

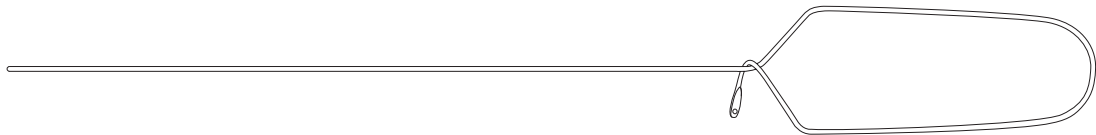

Code	Description
fos-GY/071	Straight, 2mm ø
fos-GY/071a	Curved, 2mm ø

Catheter Introducer



Code	Description
fos-GY/071b	Fine, 395mm long

Catheter Introducer

Bulbous end, with eye in handle



Code	Description
fos-GY/071c	Curved, 2mm x 410mm long

Catheter Introducer

With eye in handle, curved



Code	Description
fis-GY.071d	2mm x 420mm long

Catheter Introducer

Fixed handle



Code	Description
fis-GY.071e	445mm long

Catheter Introducer



Code	Description
fis-GY.071f	400mm long

Catheter Introducer

410mm long



Code	Description
fis-GY.071g	410mm long

Scissors

Barnes Episiotomy Scissors

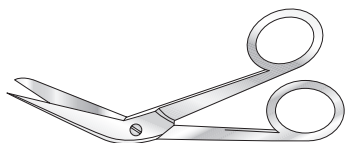

Code	Description
fis-GY/032	127mm long

Braun Stadler Episiotomy Scissors

Matt finish

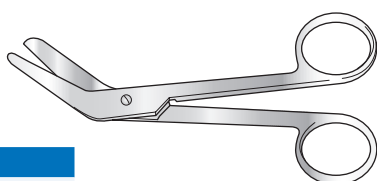

Code	Description
fis-GY/063	140mm long
fis-GY/064	222mm long

Vant Episiotomy Scissors

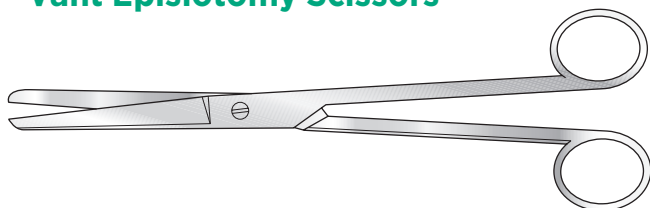

Code	Description
fis-GY/033	76mm blades, 241mm long

Busch Umbilical Scissors

Matt finish

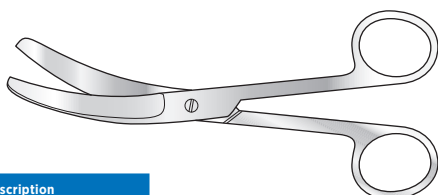

Code	Description
fis-GY/116	160mm long

Umbilical Scissors

American pattern

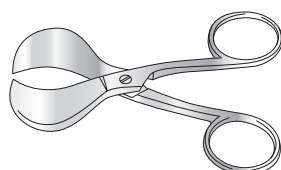

Code	Description
fis-GY/031	102mm long

Simms Uterine Scissors

Curved, tungsten carbide, with two gold bows

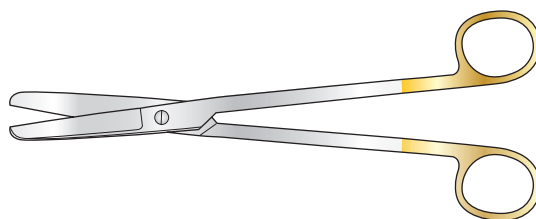

Code	Description
fis-GY/115	200mm long



Dubois Uterine Scissors

Matt finish

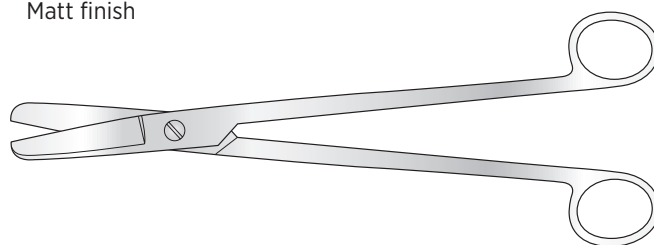

Code	Description
fis-GY/114	270mm long

Uterine Scissors

Curved on flat

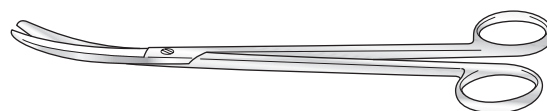

Code	Description
fis-GY/030a	203mm long

Uterine Scissors

Angled on flat

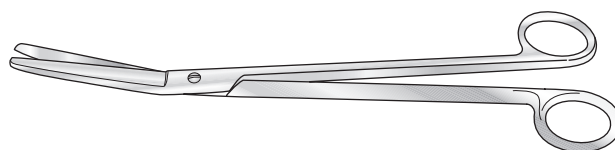

Code	Description
fis-GY/030b	230mm long

Parametrium Scissors

225mm long

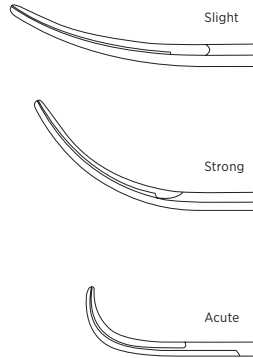
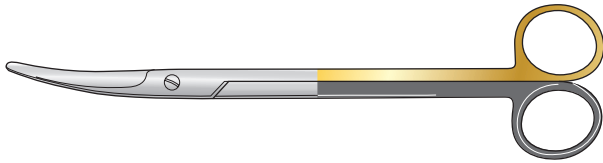

Tungsten carbide, standard, with two gold bows

Code	Description
fos-GY/080	Slight curve
fos-GY/080a	Strong curve
fos-GY/080b	Acute curve

Tungsten carbide, supercut, with one gold and one black bow

Code	Description
fos-GY/081	Slight curve
fos-GY/081a	Strong curve
fos-GY/081b	Acute curve

Miscellaneous

Bonney Myomectomy Clamp

With 51mm jaws, screw joint

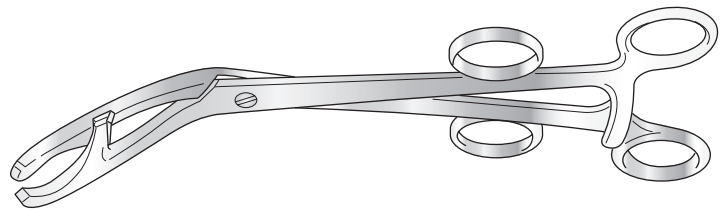

Code	Description
fos-GY/004	267mm long

Sims Vaginal Depressor

Double ended

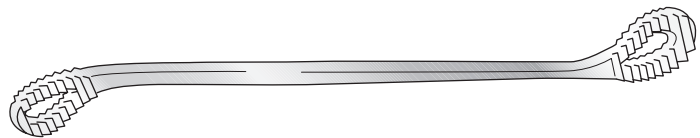

Code	Description
fos-GY/039	260mm long

Spackman Uterine Cannula

Chrome plated, 360mm long



Code	Description
fos-GY/040	12 F.G. with rubber cone
fos-GY/040a	14 F.G. with metal cone
fos-GY/040b	14 F.G. with rubber cone
fos-GY/040c	18 F.G. with metal cone
fos-GY/040d	18 F.G. with rubber cone

Doyen Myoma Screw Large



Code	Description
fos-GY/006a	178mm long

Doyen Myoma Screw Small

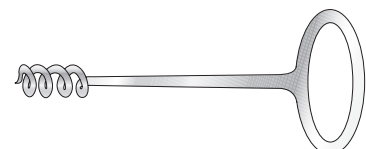

Code	Description
fos-GY/006b	178mm long

Dilators and Sounds

Galabin Uterine Sound

Calibrated 4-24, bright finish



Code	Description
fos-GY/106	305mm long

Sims Uterine Sound

Calibrated 4-24, bright finish



Code	Description
fos-GY/107	320mm long

Umbilical Dilator



Code	Description
fos-GY/038	95mm long

Hawkin Ambler Cervix Dilators

Conical, 171mm long



Code	Description
fos-GY/050	Set of 12
fos-GY/051	Size 3 - 6mm
fos-GY/052	Size 4 - 7mm
fos-GY/053	Size 5 - 8mm
fos-GY/054	Size 6 - 9mm
fos-GY/055	Size 7 - 10mm
fos-GY/056	Size 8 - 11mm

Code	Description
fos-GY/057	Size 9 - 12mm
fos-GY/058	Size 10 - 13mm
fos-GY/059	Size 11 - 14mm
fos-GY/060	Size 12 - 15mm
fos-GY/061	Size 13 - 16mm
fos-GY/062	Size 14 - 17mm

Hegar Cervix Dilator

Single ended, 185mm long



Code	Description
fos-GY/70SE1	1mm ø
fos-GY/70SE2	2mm ø
fos-GY/70SE3	3mm ø
fos-GY/70SE4	4mm ø
fos-GY/70SE5	5mm ø
fos-GY/70SE6	6mm ø
fos-GY/70SE7	7mm ø
fos-GY/70SE8	8mm ø
fos-GY/70SE9	9mm ø

Code	Description
fos-GY/70SE10	10mm ø
fos-GY/70SE11	11mm ø
fos-GY/70SE12	12mm ø
fos-GY/70SE13	13mm ø
fos-GY/70SE14	14mm ø
fos-GY/70SE15	15mm ø
fos-GY/70SE16	16mm ø
fos-GY/70SE17	17mm ø

Hegar Cervix Dilator

Double ended, 200mm long



Code	Description
fos-GY/070j	Set of 8: from sizes 1 and 2mm to 15 and 16mm
fos-GY/070h	1 and 2mm ø
fos-GY/070	3 and 4mm ø
fos-GY/070a	5 and 6mm ø
fos-GY/070b	7 and 8mm ø

Code	Description
fos-GY/070c	9 and 10mm ø
fos-GY/070d	11 and 12mm ø
fos-GY/070e	13 and 14mm ø
fos-GY/070f	15 and 16mm ø
fos-GY/070g	17 and 18mm ø

Intestinal

Forceps	110
Clamps	112
Miscellaneous	113

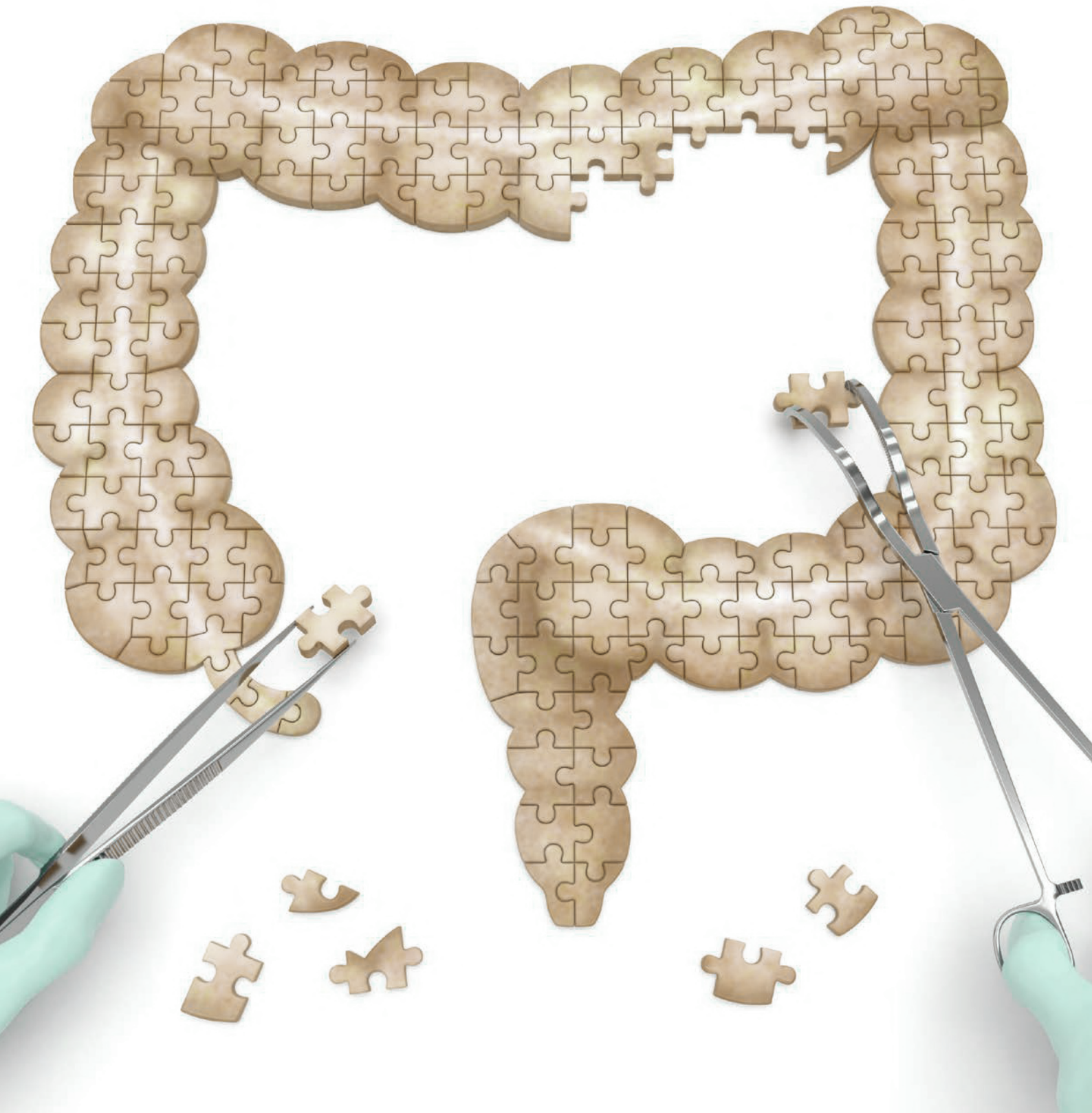

Forceps

Desjardin Gall Stone Forceps

Screw joint

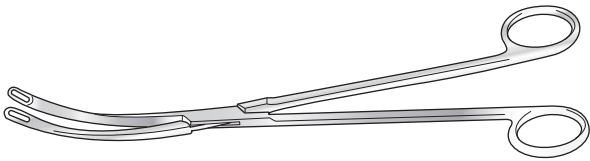

Code	Description
fos-IN/001a	Small, 220mm long
fos-IN/001b	Large, 238mm long

Lane Stomach Holding Forceps

Straight, serrated jaws, screw joint

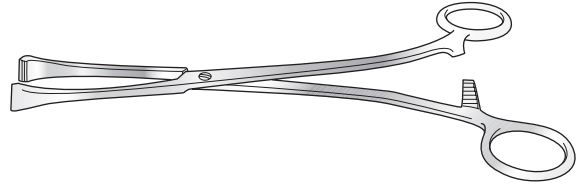

Code	Description
fos-IN/008	203mm long

Babcock Intestinal Forceps

Straight, extra light

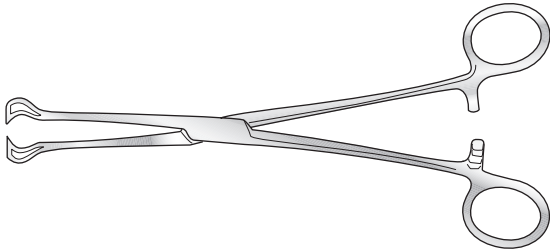

Code	Description
fos-GI/278	203mm long

Lahey Cholecystectomy Forceps

Curved, longitudinal serrations, heavier pattern

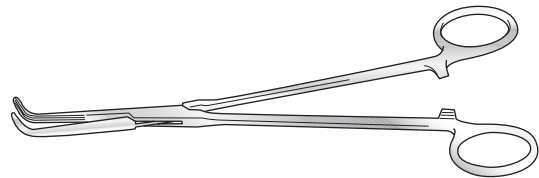

Code	Description
fos-IN/011	76mm blades, 197mm long
fos-IN/011a	225mm long

Maingot Intestinal Forceps

Straight, serrated tip, fenestrated grip

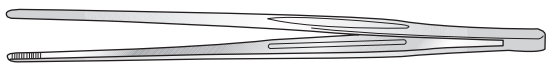

Code	Description
fos-IN/006	203mm long

Lahey Sweet Forceps

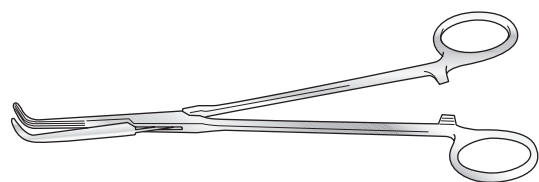

Code	Description
fos-IN/011b	200mm long
fos-IN/011c	225mm long
fos-IN/011d	230mm long

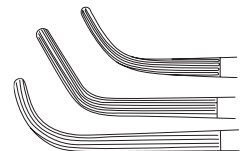

Denis Browne Intestinal Forceps

Straight, serrated tips, fenestrated jaws



Code	Description
fos-IN/007	178mm long

Moynihan Cholecystectomy Forceps

Curved on flat, screw joint

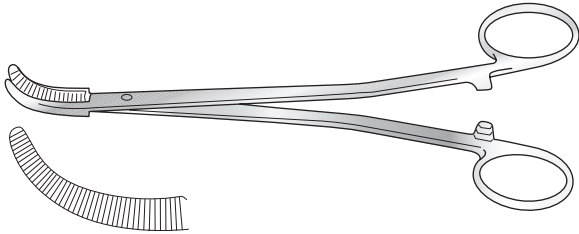

Code	Description
fos-IN/012	215mm long

Kocher Intestinal Forceps

With light spring blades and longitudinal serrations

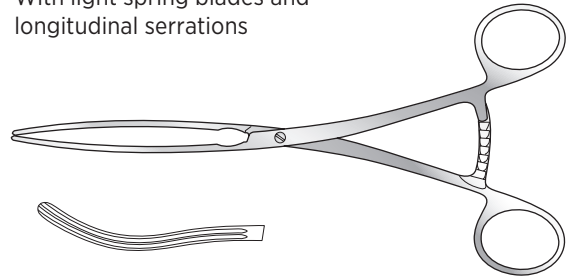

Code	Description
fos-IN/015a	Straight, 90mm blades, 210mm long
fos-IN/015b	Curved, 85mm blades, 210mm long

Lane Intestinal Forceps

110mm blades, longitudinal serrations
240mm long

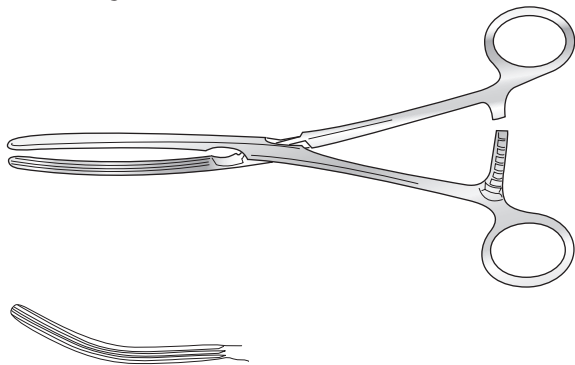

Code	Description
fos-IN/013	Straight
fos-IN/013b	Curved

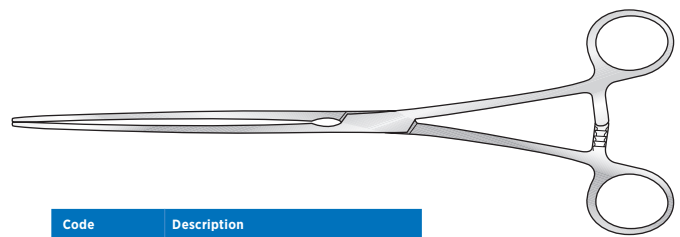

Code	Description
fos-IN/015c	Straight, 120mm blades, 250mm long
fos-IN/015d	Curved, 115mm blades, 250mm long
fos-IN/015e	Straight, 150mm blades, 250mm long
fos-IN/015f	Curved, 145mm blades, 250mm long

Seton Pringle Intestinal Forceps

Straight, longitudinal serrations
178mm long

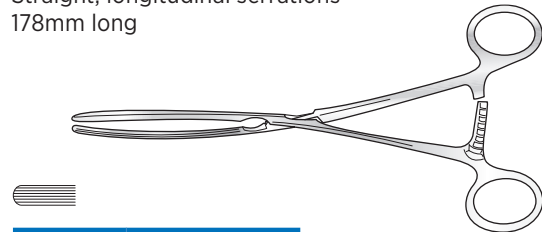

Code	Description
fos-IN/014	Fine blades 2.5mm wide

Forceps and Clamps

Lang Stevenson Intestinal Forceps

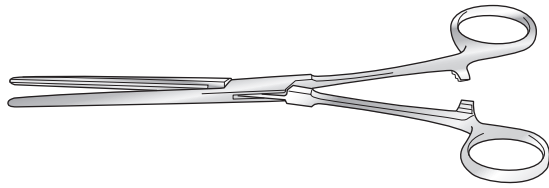

Code	Description
fos-IN/018	82mm jaw, keyed blades, 203mm long



Schoemaker-Ogilvie Colectomy Forceps

Straight, hollow blades

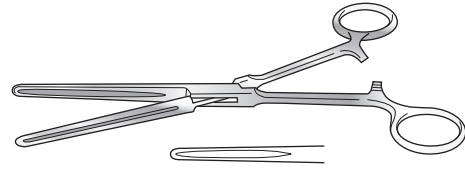

Code	Description
fos-IN/020	171mm long
fos-IN/020a	203mm long

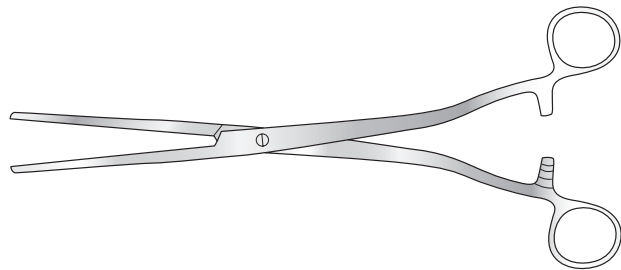

Parker Kerr Intestinal Forceps/Clamp

Blades 89mm, 254mm long

Code	Description
fos-IN/017a	Curved
fos-IN/017c	Straight



Hartman Intestinal Clamp

With diagonal serrations, 200mm long

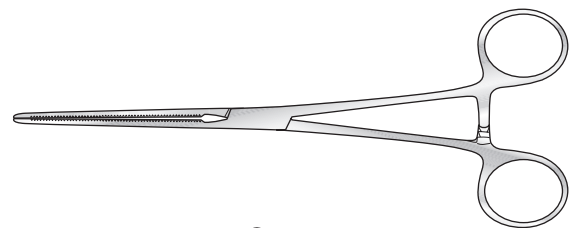

Code	Description
fos-IN/015g	Straight
fos-IN/015h	Curved

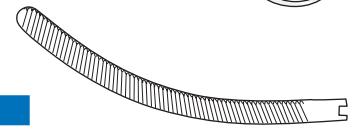

Guard/Shoe

fos-IN/017b curved, fenestrated inner or outer curve, 89mm

Code	Description
fos-IN/017d	Straight, 89mm

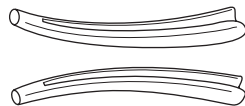

Payr Intestinal Clamp

Crushing, lever action, longitudinal serrations

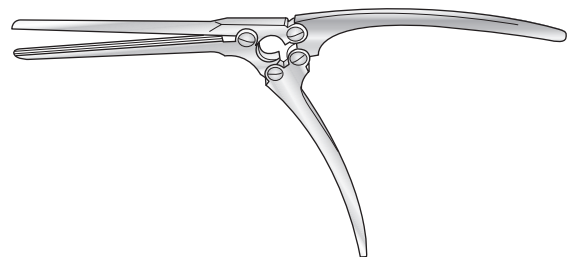

Code	Description
fos-IN/003	Extra small, 50mm blades, 150mm long
fos-IN/002a	Small, 65mm blades, 210mm long
fos-IN/002b	Medium, 100mm blades, 240mm long
fos-IN/002c	Large, 150mm blades graduated in inches, 360mm long

Doyen Intestinal Clamp

240mm long

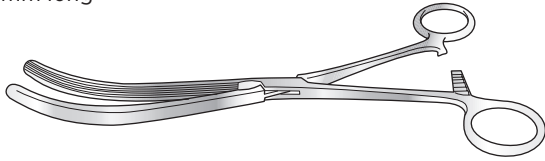

Code	Description
fos-IN/004a	Straight
fos-IN/004b	Curved

Lane Twin Stomach Clamp

Longitudinal serrations
large, 150mm blades, 305mm long

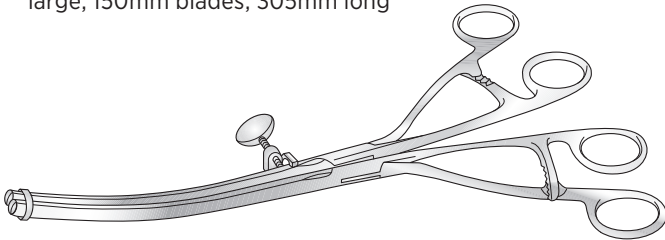

Code	Description
fos-IN/009b	Straight
fos-IN/009a	Curved

Zachary Cope Anastomosis Clamp

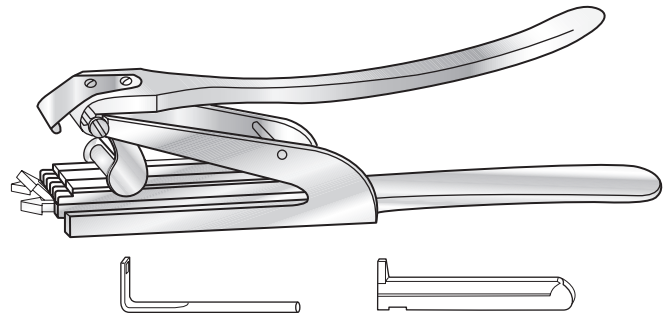

Code	Description
fos-IN/010a	Set: 3 clamps, lever action closing device and tommy bar, 233mm long
fos-IN/010b	Set of 3 clamps
fos-IN/010c	Tommy bar for set, 103mm long

Bakes Bile Duct Dilators

Malleable stems, 203mm long



Code	Description
fos-IN/016a	Set of nine
fos-IN/016c	3mm ø head
fos-IN/016d	4mm ø head
fos-IN/016e	5mm ø head
fos-IN/016f	6mm ø head

Code	Description
fos-IN/016g	7mm ø head
fos-IN/016h	8mm ø head
fos-IN/016i	9mm ø head
fos-IN/016j	10mm ø head
fos-IN/016k	11mm ø head

Yankauer Suction Tube

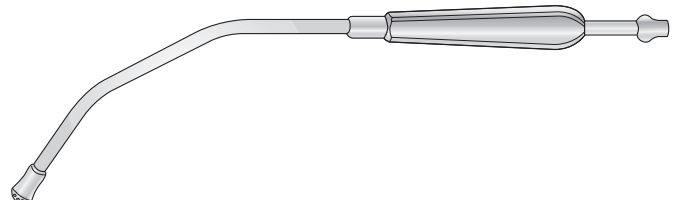

Code	Description
fos-IN/019	305mm long



Neuro/ Spinal Surgery

Forceps	115
Scissors	117
Dissectors and Probes	118
Hooks and Curettes	119
Retractors	120
Elevators	123
Suction Tubes	124
Rongeurs	125

Adson Dissecting Forceps

Bayonet, 1-2 teeth, jaw 2.5mm at tip



Code	Description
fos-NEU/001c	191mm long

Jefferson Dressing Forceps



Code	Description
fos-NEU/013	Serrated jaws, 178mm long

Adson Dissecting Forceps

Bayonet, fine, serrated jaws, jaw 2.5mm at tip

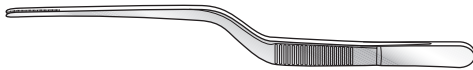

Code	Description
fos-NEU/009	178mm long

Jefferson Forceps



Code	Description
fos-NEU/002	Fine, 1-2 teeth, 178mm long

Northfield Dressing Forceps

Extra light, serrated jaws



Code	Description
fos-NEU/014	1mm wide, 203mm long

Pennybacker Dissecting Forceps



Code	Description
fos-NEU/005	3-4 teeth, 165mm long

Forceps

Silcock Iris Forceps

102mm long



Code	Description
fos-NEU/006	1-2 teeth
fos-NEU/015	Serrated jaws

Dott Dissecting Forceps

Fine, 1-2 teeth



Code	Description
fos-NEU/004	178mm long

Cairns Dissecting Forceps

Delicate, 2-3 teeth

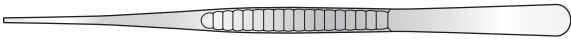

Code	Description
fos-NEU/003a	165mm long
fos-NEU/003b	216mm long

Dott Dressing Forceps

Angled

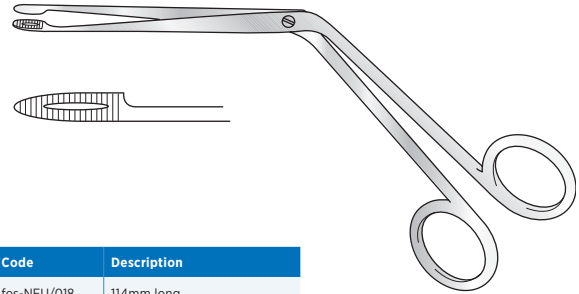

Code	Description
fos-NEU/018	114mm long

Cairns (Dott) Dressing Forceps

Serrated jaws



Code	Description
fos-NEU/010	Medium, 2mm wide, 216mm long
fos-NEU/012	Fine, 1mm wide, 178mm long

Tilley Dressing Forceps

Angled, serrated ends

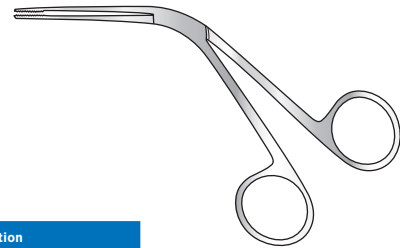

Code	Description
fos-NEU/017	89mm long

Cairns Scissors

Angled on flat

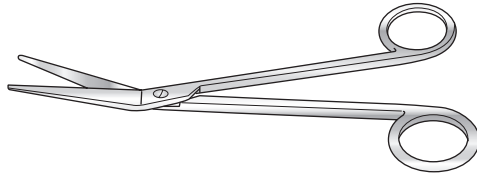

Code	Description
fos-NEU/020	178mm long

Olivecrona Scissors

Angled, with all micro serrated blade

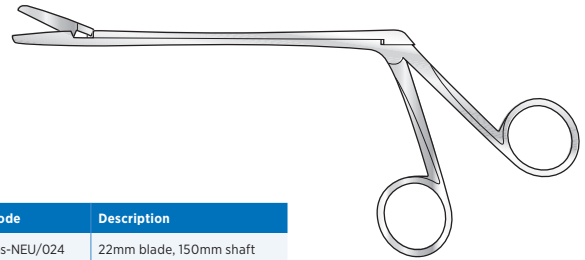

Code	Description
fos-NEU/024	22mm blade, 150mm shaft

McKissock Scissors

Straight

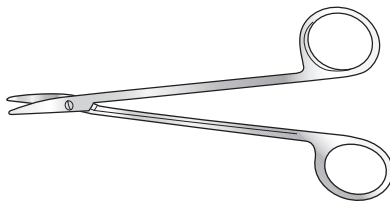

Code	Description
fos-NEU/021a	146mm long

Schmieden (Taylor) Scissors

Angled, probe-pointed under blade

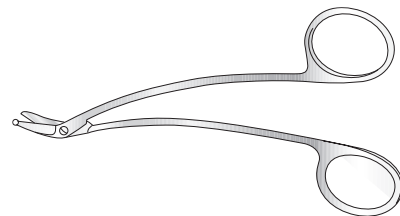

Code	Description
fos-NEU/023	146mm long

Sweet Scissors

Delicate

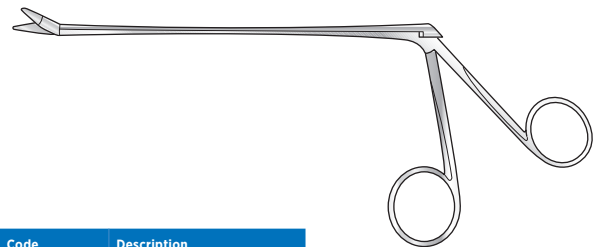

Code	Description
fos-NEU/025a	7mm blade, 144mm shaft
fos-NEU/030	13mm blade, 117mm shaft

Dissectors and Probes

Cairns Guide and Director

Malleable



Code	Description
fos-NEU/080	127mm long

Pennybacker Probe Dissector

Double ended



Code	Description
fos-NEU/101	229mm long

Dissector

200mm long



Code	Description
fos-NEU/N30210	Soft
fos-NEU/N30220	Soft, with hole

Swedish Dissector

Double ended



Code	Description
fos-NEU/100a	Light model, 178mm long
fos-NEU/100b	Heavy model, 200mm long

Penfield Dissector



No 1

Broad curve, with 7.5mm sharp round spoon, 184mm long



No 2

7.5mm sharp round spoon with wax packer, 178mm long



No 3

Full curve and wax packer, 197mm long



No 4

Slight curve, 4mm wide, 216mm long

Code	Description
fos-NEU/069a	No 1
fos-NEU/069b	No 2
fos-NEU/069c	No 3
fos-NEU/069d	No 4

Watson Cheyne Dissector

Fine, double-ended, with probe end



Code	Description
fos- 2 87	127mm long
fos- 2 88	191mm long
fos- 2 88a	230mm long
fos- 2 88b	255mm long

Hooks and Curettes

Hooks

Adson Hook

178mm long



Code	Description
fos-NEU/078a	Angled
fos-NEU/078b	Straight
fos-NEU/078b-b	Straight, blunt

Adson Oliver Neuro Hook

191mm long

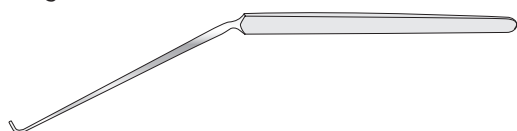

Code	Description
fos-NEU/082a	Angled downward, blunt
fos-NEU/082b	Sharp
fos-NEU/082c	Angled upward, blunt

Cairns Tissue Hook

127mm long



Code	Description
fos-NEU/081b	Half round, sharp
fos-NEU/081c	Angled, sharp

Oliver Tissue Hook

Blunt



Code	Description
fos-NEU/081a	127mm long

Curettes

Falconer Scoop Curette

Double ended, angled ends



Code	Description
fos-NEU/099	191mm long

American Spinal Fusion Curettes

Blue acetal handles, 254mm long



Straight

Code	Description
fos-NEU/074a	Size 000 2mm x 4mm
fos-NEU/074b	Size 00 2.5mm x 4.5mm
fos-NEU/074c	Size 0 2.75mm x 5mm
fos-NEU/074d	Size 1 3mm x 5.5mm
fos-NEU/074e	Size 2 3.25mm x 6mm
fos-NEU/074f	Size 3 4mm x 7mm
fos-NEU/074g	Size 4 6mm x 9.5mm
fos-NEU/074h	Size 5 7mm x 14mm
fos-NEU/074i	Size 6 9mm x 17mm

Angled

Code	Description
fos-NEU/074j	Size 000 2mm x 4mm
fos-NEU/074k	Size 00 2.5mm x 4.5mm
fos-NEU/074l	Size 0 2.75mm x 5mm
fos-NEU/074m	Size 1 3mm x 5.5mm
fos-NEU/074n	Size 2 3.25mm x 6mm
fos-NEU/074o	Size 3 4mm x 7mm
fos-NEU/074p	Size 4 6mm x 9.5mm
fos-NEU/074q	Size 5 7mm x 14mm
fos-NEU/074r	Size 6 9mm x 17mm

ALSO AVAILABLE WITH ACETAL SUREGRIP HANDLE
ADD SUFFIX BH TO CATALOGUE NUMBER

Retractors

Mastoid Retractor

3 x 3 blunt hooks

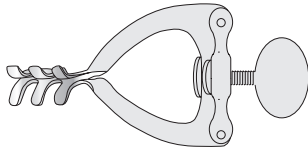

Code	Description
fos-NEU/N30350	114mm long

Henderson Retractor

Self retaining, straight, 4 x 4 blunt pointed blades

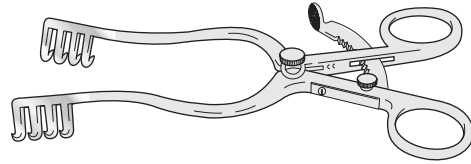

Code	Description
fos-NEU/030a	178mm long

Jansen (Shea) Retractor

Self retaining, blunt blades

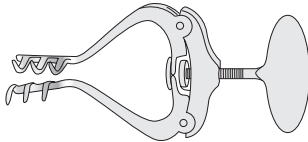

Code	Description
fos-NEU/028	114mm long

Cairns Scalp Retractor

Curved, self retaining, swivel blades

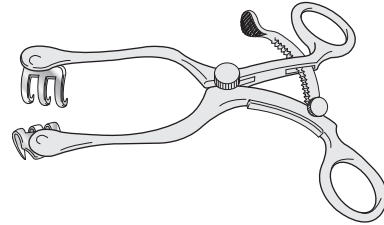

Code	Description
fos-NEU/025b	140mm long

Cone Retractor

Self retaining, hinged arms, for use in ventriculography

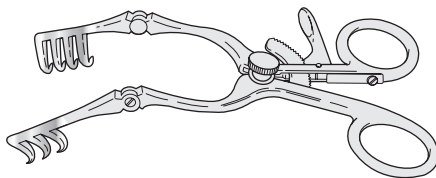

Code	Description
fos-NEU/027	165mm long

Schnitker Scalp Retractor

Curved, self retaining, blunt swivel blades

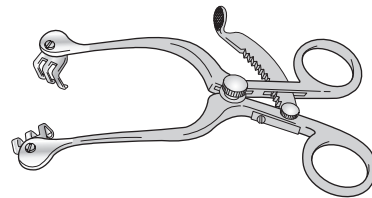

Code	Description
fos-NEU/026	140mm long

Jefferson Retractor

Self retaining, curved, blunt pointed blades

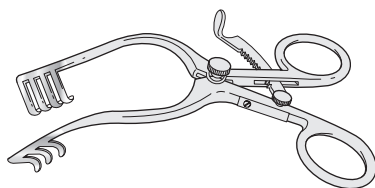

Code	Description
fos-NEU/029	140mm long

Cone Laminectomy Retractor

Hinged arms, with cam rack

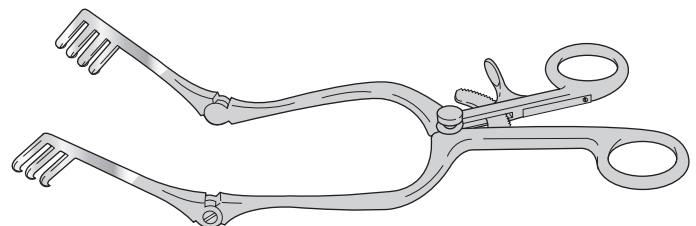

Code	Description
fos-NEU/051	254mm long

Cone Laminectomy Retractor

Hinged arms

Code	Description
fos-NEU/052a	Left, 165mm long
fos-NEU/052b	Right, 165mm long
fos-NEU/052c	Left, 254mm long
fos-NEU/052d	Right, 254mm long

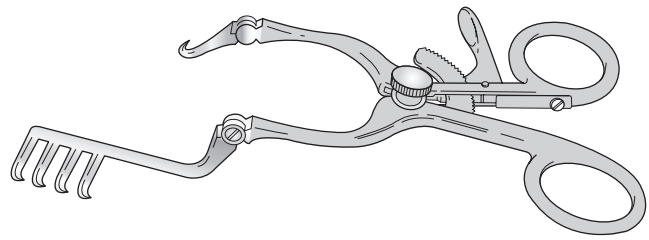

Harvey-Jackson Laminectomy Retractor

Hinged arms, blades 38mm wide x 44mm deep

Code	Description
fos-NEU/053	305mm long

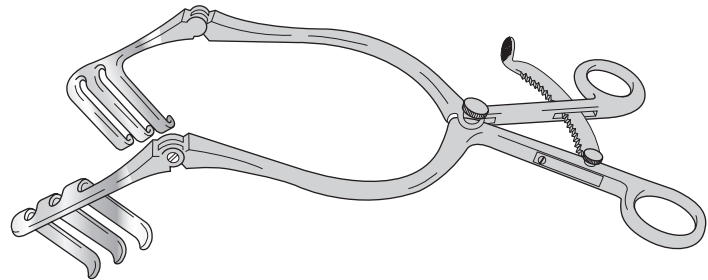

Mayo-Adson (Beckmann) Laminectomy Retractor

Hinged arms

Code	Description
fos-NEU/054	292mm long

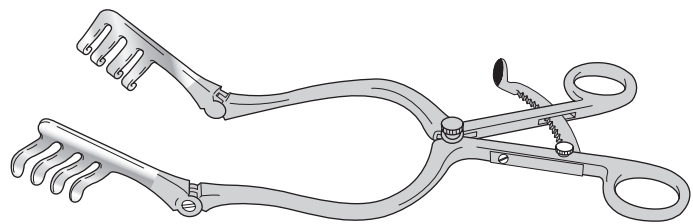

Northfield (Cairns) Retractor

Hinged arms, one pair of blades

4 prong : 25mm wide x 16mm deep
and one pair of blades

5 prong: 32mm wide x 25mm deep

Code	Description
fos-NEU/055	292mm long

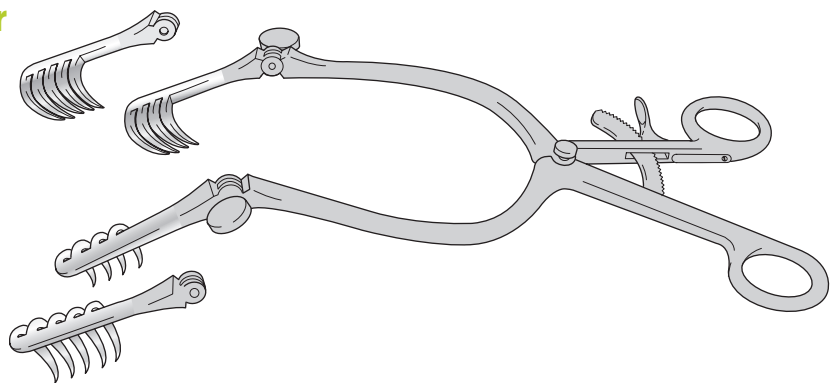

Meyerding Hemi-Laminectomy Retractor

Code	Description
fos-NEU/216	18cm long 7" blade size 50 x 10mm
fos-NEU/219	18cm long 7" blade size 50 x 20mm
fos-NEU/217	18cm long 7" blade size 60 x 10mm
fos-NEU/220	18cm long 7" blade size 60 x 20mm
fos-NEU/218	18cm long 7" blade size 70 x 10mm
fos-NEU/221	18cm long 7" blade size 70 x 20mm
fos-NEU/224	18cm long blade left 90 x 10mm
fos-NEU/225	18cm long blades left 90 x 20mm
fos-NEU/222	18cm long blades right 90 x 10mm
fos-NEU/223	18cm long blades right 90 x 20mm

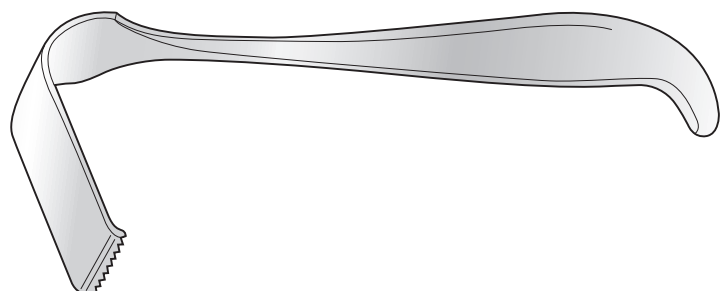

Retractors

Cairns-Northfield Laminectomy Retractor

203mm arm length with three pairs of interchangeable swivelling blades, 76mm, 64mm, and 51mm

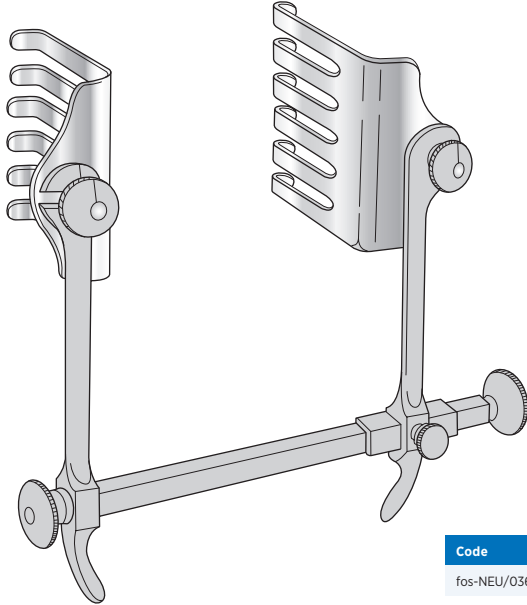

Code
fos-NEU/036

Hibbs Retractor

203mm long

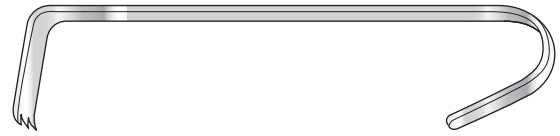

Code	Description
fos-NEU/050a	Blades 10mm x 38mm
fos-NEU/050b	Blades 16mm x 54mm

Krayenbuhl Retractor

6mm wide

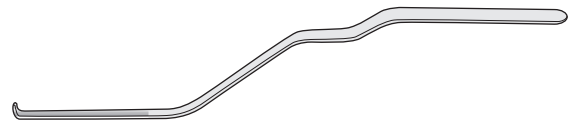

Code	Description
fos-NEU/5905	210mm long
fos-NEU/5905a	240mm long

Cairns 'Rake' Scalp Retractor

Sharp, 210mm long

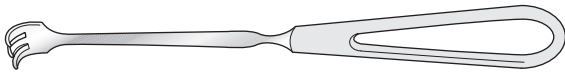

Code	Description
fos-NEU/032a	3 prong, 16mm wide
fos-NEU/032b	4 prong, 19mm wide

Love Retractor

6mm wide

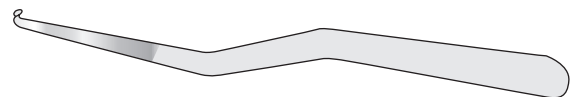

Code	Description
fos-NEU/5905b	210mm long

Cairns (Cushing) Scalp Retractor

Solid blade

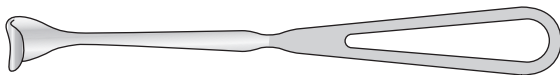

Code	Description
fos-NEU/033	16mm wide, 210mm long

Love Retractor

203mm long



Code	Description
fos-NEU/077a	Straight, blade 5mm x 5mm
fos-NEU/077b	Shaft angled 90° at handle
fos-NEU/077c	Shaft angled 45° at handle

Cairns Strip Retractor

Malleable, 203mm long
8 sizes: 6, 8, 10, 11, 13, 16, 19, 25mm

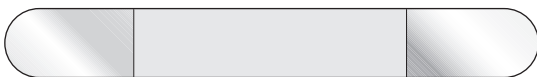

Code	Description
fos-NEU/034a	20 SWG
fos-NEU/034b	18 SWG

O'Connell Retractor

Double ended



Code	Description
fos-NEU/076	216mm long

Cobb Spinal Elevator

13mm wide, knurled handle

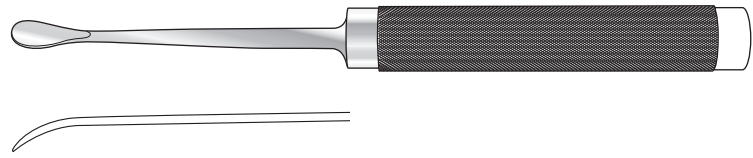

Cobb Spinal Elevator

With blue acetal handles, 279mm long

Code	Description
fos-NEU/073a	10mm wide
fos-NEU/073b	13mm wide
fos-NEU/073c	19mm wide

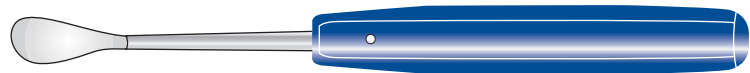

ALSO AVAILABLE WITH ACETAL SUREGRIP HANDLE
ADD SUFFIX BH TO CATALOGUE NUMBER

Adson Periosteal Elevator

Serrated grip, 165mm long

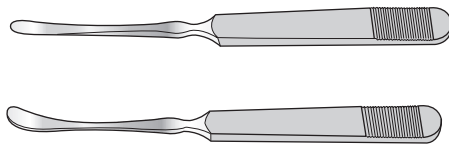

straight

Code	Description
fos-Ø/N028	7mm wide

curved

Code	Description
fos-Ø/N029	5mm wide
fos-Ø/N030	7mm wide

McKissock Spade Periosteal Elevator

Straight



Code	Description
fos-NEU/072	197mm long

Cushing Periosteal Elevator

Slightly curved end



Code	Description
fos-NEU/071	197mm long

Pennybacker Elevator

Curved, sharp, 171mm long

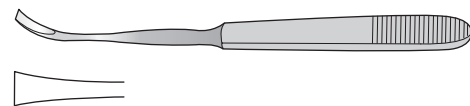

Code	Description
fos-Ø/N025	6mm wide

Suction Tubes

Adson Frazier Suction Tube

Angled, fully insulated, 180mm long



Code	Description
fos-NEU/094c	8 F.G.

Retractor Suction Tube

With stilette, 220mm long

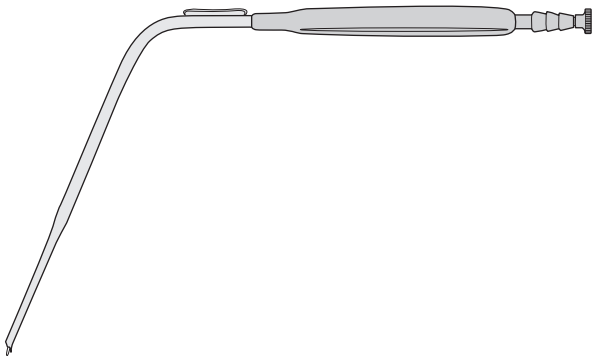

Code	Description
fos-NEU/S801STL	Replacement stilette

Frazier Suction Tubes

Malleable, silver, angled, 180mm long

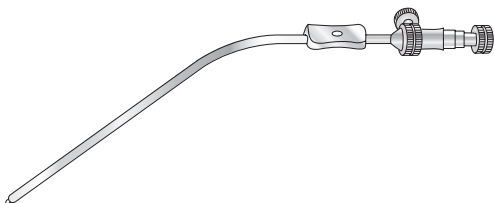

Code	Description
fos-NEU/092a	7 F.G.
fos-NEU/092b	8 F.G.
fos-NEU/092c	9 F.G.

Dandy Rongeur

Straight

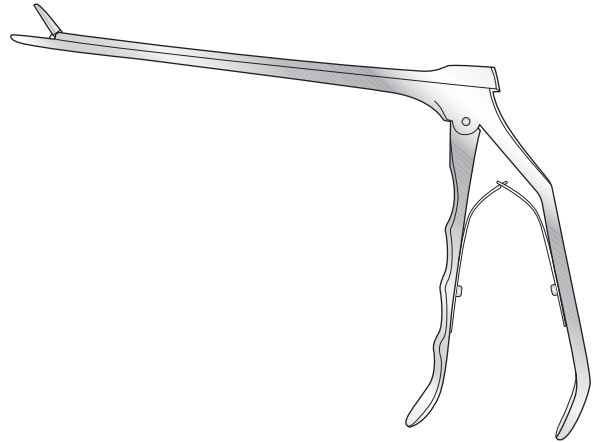

Code	Description
fos-NEU/134	3mm bite, 178mm shaft

Falconer Rongeur

Oblique jaws

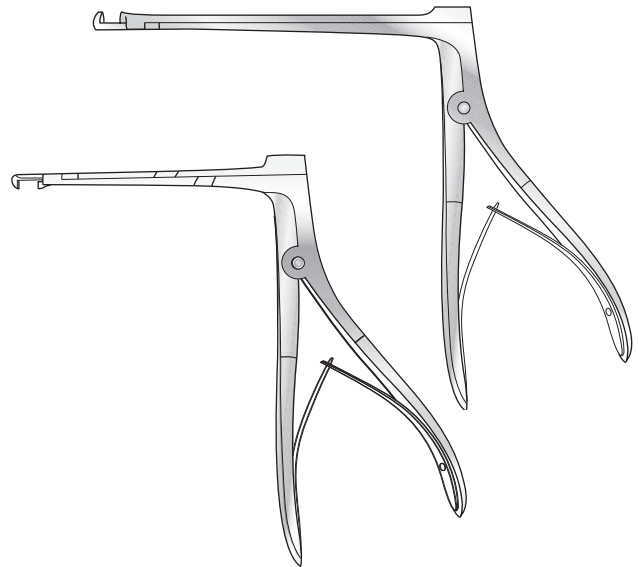

Code	Description
fos-NEU/122a	Upward cutting, 3mm bite, 110mm shaft
fos-NEU/122b	Upward cutting, 5mm bite, 110mm shaft
fos-NEU/122c	Downward cutting, 3mm bite, 85mm shaft
fos-NEU/122d	Downward cutting, 5mm bite, 110mm shaft

Beck Rongeur

Straight, for intervertebral disc

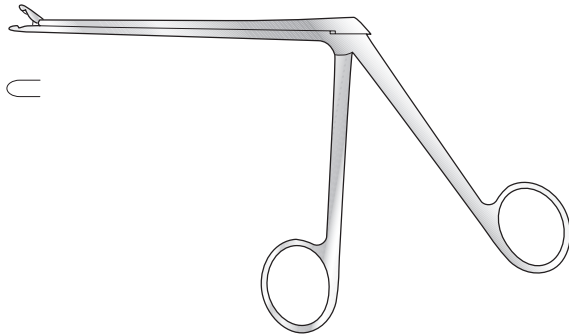

Code	Description
fos-NEU/125	2mm bite, 130mm shaft

Love-Grunwald Rongeur

Cup shaped, jaws 3mm x 10mm, 178mm shaft

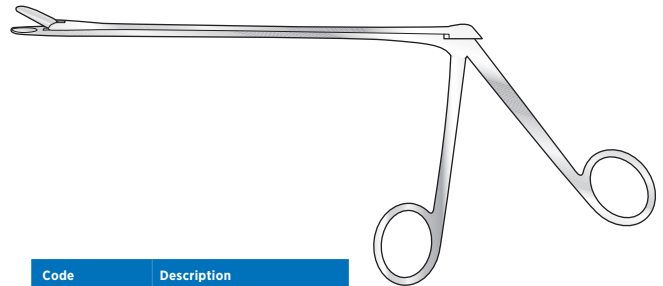

Code	Description
fos-NEU/131a	Straight
fos-NEU/131b	Curved upward
fos-NEU/131c	Curved downward

Cushing Rongeur

130mm shaft

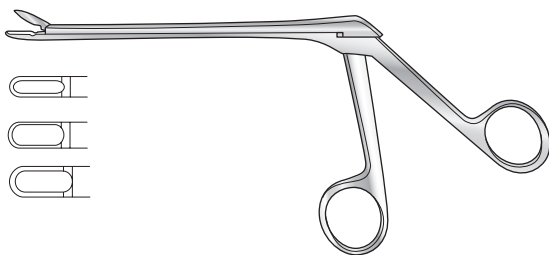

Code	Description
fos-NEU/127-2	2mm bite
fos-NEU/127-3	3mm bite
fos-NEU/127-4	4mm bite
fos-NEU/127-5	5mm bite
fos-NEU/127-6	6mm bite

Mackay Rongeur

140°, straight, 114mm shaft

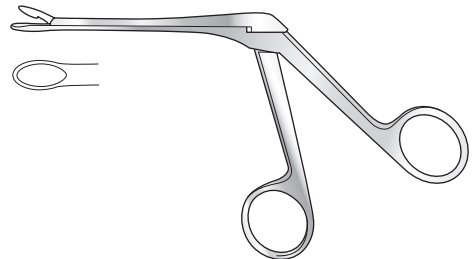

Code	Description
fos-S#4249	5.5mm

Cushing Rongeur

130mm shaft

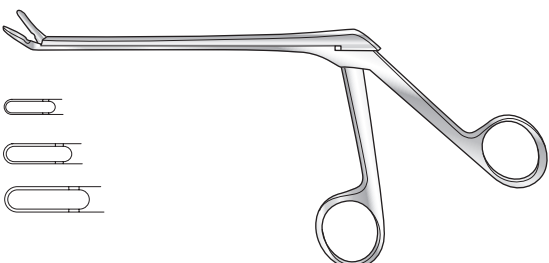

150° upward cutting

Code	Description
fos-NEU/128c	2mm bite
fos-NEU/128b	3mm bite
fos-NEU/128a	4mm bite
fos-NEU/128b	5mm bite

150° downward cutting

Code	Description
fos-NEU/130c	2mm bite
fos-NEU/130	3mm bite
fos-NEU/130a	4mm bite
fos-NEU/130b	5mm bite

Northfield Rongeur

Curved, upward cutting

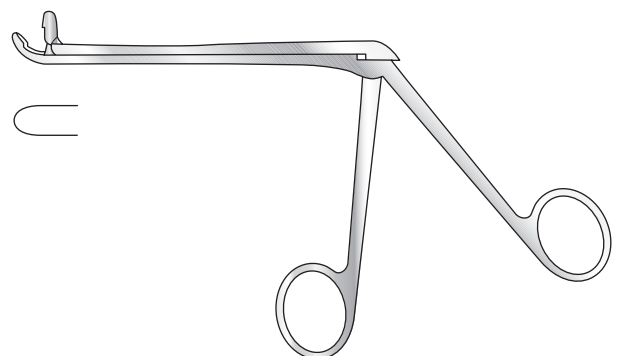

Code	Description
fos-NEU/132	4mm bite, 133mm shaft

Rongeurs

Pennybacker Rongeur

120mm shaft

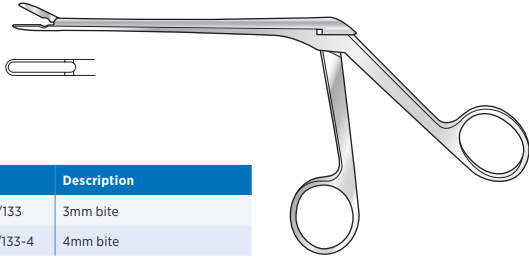

Code	Description
fos-NEU/133	3mm bite
fos-NEU/133-4	4mm bite

Daniel Rongeur

Miniature, for neuropathology

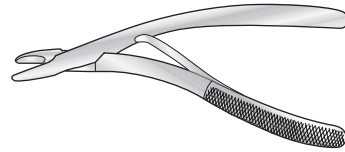

Code	Description
fos-NEU/104	1.5mm bite, 127mm long

St Bart's Rongeur

114mm shaft



Code	Description
fos-ENT/140a	3mm bite

Cairns Rongeur

Fine jaws, angled on flat, serrated jaws, curved handles

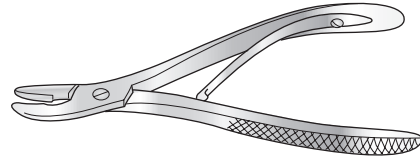

Code	Description
fos-NEU/103	4mm bite 152mm long

St Bart's Rongeur

140°, downward cutting, 114mm shaft

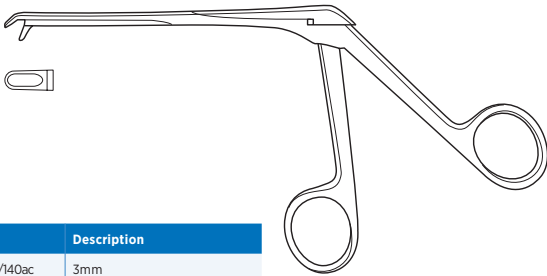

Code	Description
fos-ENT/140ac	3mm

Danish Pattern Rongeur

Angled on flat, fine jaws, curved handles, screw joint

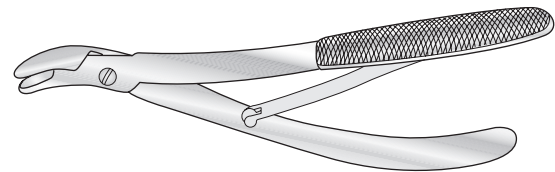

Code	Description
fos-NEU/109	4mm bite, 203mm long

St Bart's Rongeur

140°, upward cutting, 114mm shaft

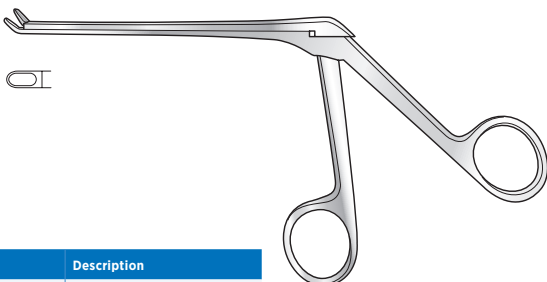

Code	Description
fos-ENT/140b	3mm

Falconer Rongeur

Angled to side, light, screw joint

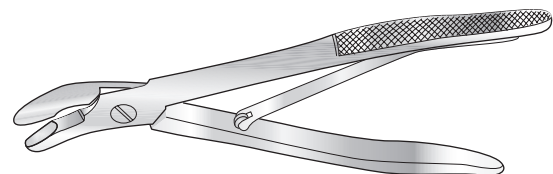

Code	Description
fos-NEU/110	6mm bite, 203mm long

Wilms Rongeur

Angled on flat, narrow jaws

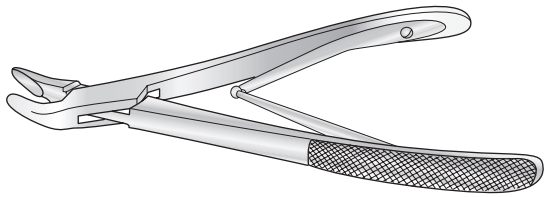

Code	Description
fos-NEU/114	4mm bite, 203mm long

Pennybacker Rongeur

Straight, fine jaws, 203mm long

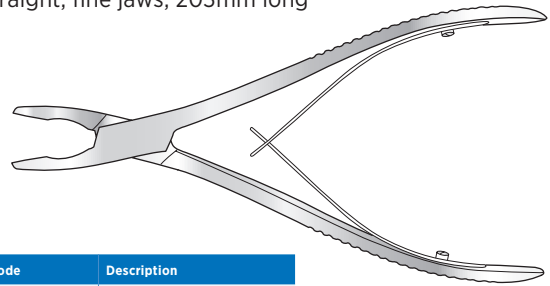

Code	Description
fos-NEU/107	4mm bite

Glasgow Pattern Rongeur

Slightly curved on flat, screw joint

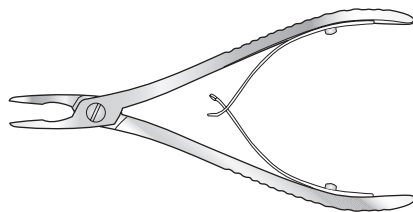

Code	Description
fos-NEU/111	4mm bite, 146mm long

Northfield Rongeur

Straight, 10mm bite

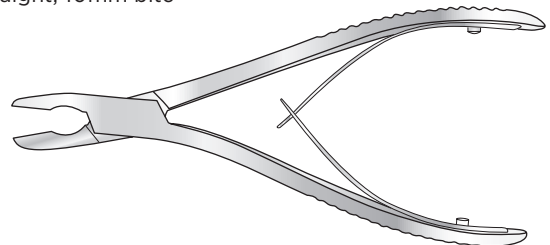

Code	Description
fos-NEU/106	One shallow blade, 200mm long

Heanley Rongeur

Long fine straight jaws, screw joint

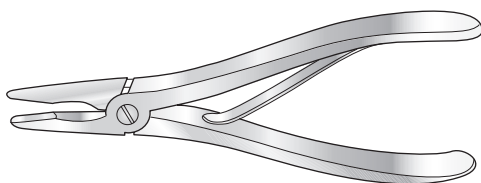

Code	Description
fos-NEU/112	4mm bite, 178mm long

Stokey Rongeur

Angled to side, fine jaws

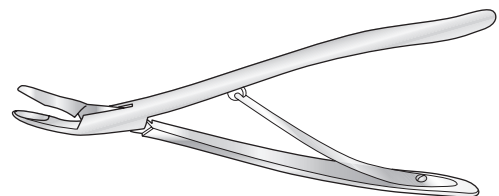

Code	Description
fos-NEU/108	3mm bite, 178mm long

Jansen Rongeur

Short curve, screw joint

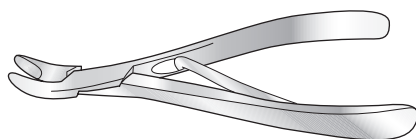

Code	Description
fos-NEU/105	8mm bite, 152mm long

Trotter Rongeur

Angled to side, strong, screw joint

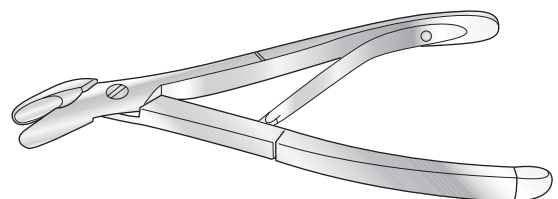

Code	Description
fos-NEU/113	10mm bite, 203mm long

Rongeurs

Luer-Jansen Rongeur

Light, curved on flat, compound action

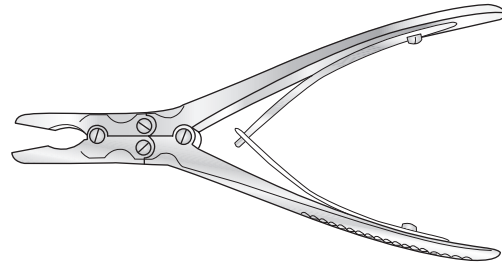
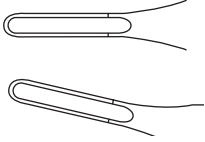

Code	Description
fos-NEU/116	4mm bite, 197mm long

Olivecrona Rongeur

Angled to side, compound action, 229mm long

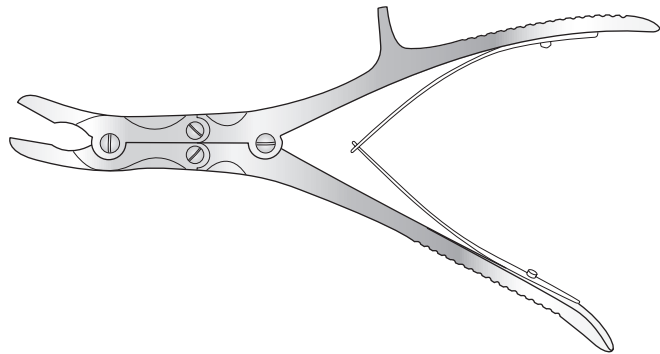

Code	Description
fos-NEU/119a	5mm bite
fos-NEU/119b	6mm bite

Ruskin Rongeur

Curved on flat, compound action

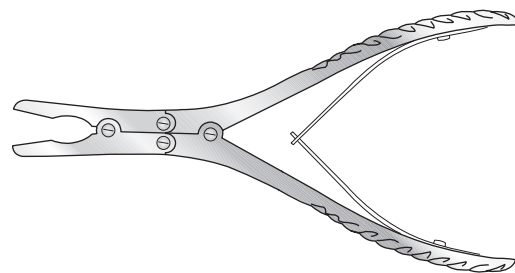

Code	Description
fos-NEU/118	6mm bite, 184mm long

Leksell Rongeur

Curved to side, compound action

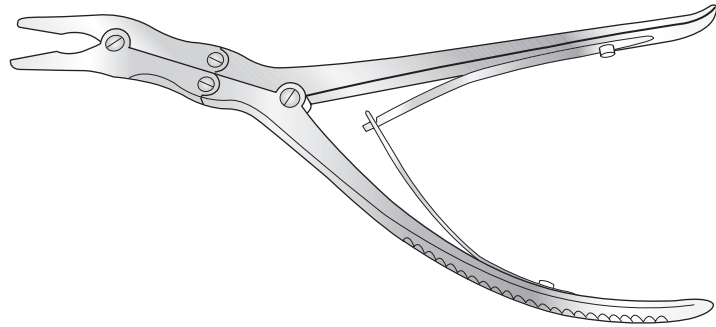
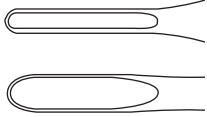

Code	Description
fos-NEU/115a	Small, 6mm bite, 229mm long
fos-NEU/115b	Large, 8mm bite, 254mm long

Luer Stille Bone Rongeur

Curved, 250mm long

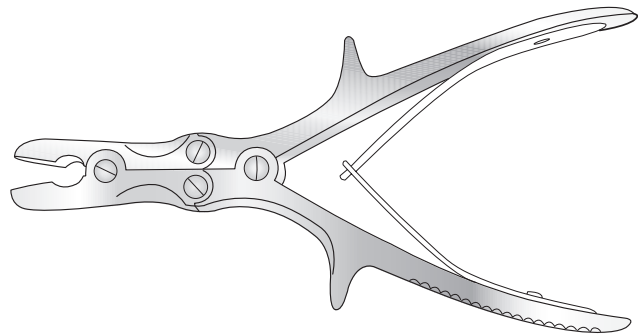
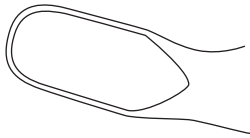

Code	Description
fos-B/071b	11mm bite
fos-NEU/117	Heavy, 229mm long

Swedish Pattern Laminectomy Shears

Double crank, compound action

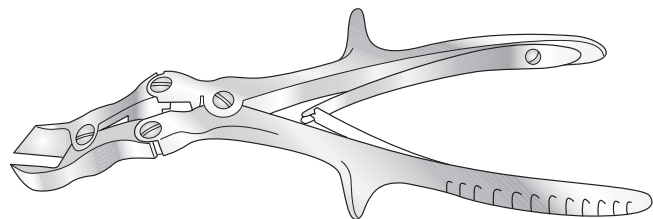

Code	Description
fos-NEU/121	267mm long

Rongeurs

Kerrison Rongeurs

Cloward disc punch (not illustrated)
130° upward cutting, 190mm long

BLACK CERAMIC COATED KERRISONS AVAILABLE
PLEASE ADD SUFFIX -BK WHEN ORDERING

Code	Description
fos-NEU/CD02	2mm wide
fos-NEU/CD03	3mm wide
fos-NEU/CD04	4mm wide
fos-NEU/CD05	5mm wide
fos-NEU/CD06	6mm wide



Kerrison punch

1mm □ 2mm □ 3mm □ 4mm □ 5mm □

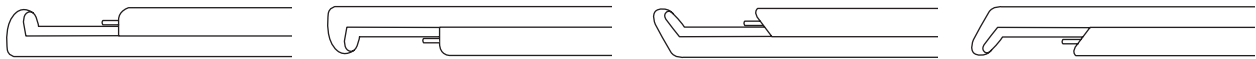

Non-Detachable

90° upward cutting

Code	Description
fos-NEU/136	180mm(L) x 1mm(W)
fos-NEU/137	180mm(L) x 2mm(W)
fos-NEU/138	180mm(L) x 3mm(W)
fos-NEU/139	180mm(L) x 4mm(W)
fos-NEU/140	180mm(L) x 5mm(W)
fos-NEU/141	230mm(L) x 2mm(W)
fos-NEU/142	230mm(L) x 3mm(W)
fos-NEU/143	230mm(L) x 4mm(W)
fos-NEU/144	230mm(L) x 5mm(W)

90° downward cutting

Code	Description
fos-NEU/154	180mm(L) x 1mm(W)
fos-NEU/155	180mm(L) x 2mm(W)
fos-NEU/156	180mm(L) x 3mm(W)
fos-NEU/157	180mm(L) x 4mm(W)
fos-NEU/158	180mm(L) x 5mm(W)
fos-NEU/159	230mm(L) x 2mm(W)
fos-NEU/160	230mm(L) x 3mm(W)
fos-NEU/161	230mm(L) x 4mm(W)
fos-NEU/162	230mm(L) x 5mm(W)

130° upward cutting

Code	Description
fos-NEU/172	180mm(L) x 1mm(W)
fos-NEU/173	180mm(L) x 2mm(W)
fos-NEU/174	180mm(L) x 3mm(W)
fos-NEU/175	180mm(L) x 4mm(W)
fos-NEU/176	180mm(L) x 5mm(W)
fos-NEU/177	200mm(L) x 3mm(W)
fos-NEU/178	200mm(L) x 4mm(W)
fos-NEU/179	200mm(L) x 5mm(W)
fos-NEU/180	200mm(L) x 6mm(W)
fos-NEU/181	230mm(L) x 2mm(W)
fos-NEU/182	230mm(L) x 3mm(W)
fos-NEU/183	230mm(L) x 4mm(W)
fos-NEU/184	230mm(L) x 5mm(W)

130° downward cutting

Code	Description
fos-NEU/198	180mm(L) x 1mm(W)
fos-NEU/199	180mm(L) x 2mm(W)
fos-NEU/200	180mm(L) x 3mm(W)
fos-NEU/201	180mm(L) x 4mm(W)
fos-NEU/202	180mm(L) x 5mm(W)
fos-NEU/203	230mm(L) x 2mm(W)
fos-NEU/204	230mm(L) x 3mm(W)
fos-NEU/205	230mm(L) x 4mm(W)
fos-NEU/206	230mm(L) x 5mm(W)

Detachable

90° upward cutting

Code	Description
fos-NEU/145	180(L) x 1mm(W)
fos-NEU/146	180(L) x 2mm(W)
fos-NEU/147	180(L) x 3mm(W)
fos-NEU/148	180(L) x 4mm(W)
fos-NEU/149	180(L) x 5mm(W)
fos-NEU/150	230(L) x 2mm(W)
fos-NEU/151	230(L) x 3mm(W)
fos-NEU/152	230(L) x 4mm(W)
fos-NEU/153	230(L) x 5mm(W)

90° downward cutting

Code	Description
fos-NEU/163	180(L) x 1mm(W)
fos-NEU/164	180(L) x 2mm(W)
fos-NEU/165	180(L) x 3mm(W)
fos-NEU/166	180(L) x 4mm(W)
fos-NEU/167	180(L) x 5mm(W)
fos-NEU/168	230(L) x 2mm(W)
fos-NEU/169	230(L) x 3mm(W)
fos-NEU/170	230(L) x 4mm(W)
fos-NEU/171	230(L) x 5mm(W)

130° upward cutting

Code	Description
fos-NEU/185	180(L) x 1mm(W)
fos-NEU/186	180(L) x 2mm(W)
fos-NEU/187	180(L) x 3mm(W)
fos-NEU/188	180(L) x 4mm(W)
fos-NEU/189	180(L) x 5mm(W)
fos-NEU/190	200(L) x 3mm(W)
fos-NEU/191	200(L) x 4mm(W)
fos-NEU/192	200(L) x 5mm(W)
fos-NEU/193	200(L) x 6mm(W)
fos-NEU/194	230(L) x 2mm(W)
fos-NEU/195	230(L) x 3mm(W)
fos-NEU/196	230(L) x 4mm(W)
fos-NEU/197	230(L) x 5mm(W)

130° downward cutting

Code	Description
fos-NEU/207	180(L) x 1mm(W)
fos-NEU/208	180(L) x 2mm(W)
fos-NEU/209	180(L) x 3mm(W)
fos-NEU/210	180(L) x 4mm(W)
fos-NEU/211	180(L) x 5mm(W)
fos-NEU/212	230(L) x 2mm(W)
fos-NEU/213	230(L) x 3mm(W)
fos-NEU/214	230(L) x 4mm(W)
fos-NEU/215	230(L) x 5mm(W)



Ophthalmic/ Micro

Forceps	132
Scissors	134
Needle Holders	136
Retractors	137
Speculum	137
Cannula	137
Miscellaneous	138

Forceps

Iris Forceps

1-2 teeth, 114mm long

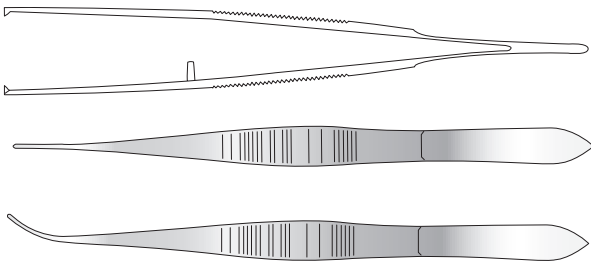

Code	Description
fos-OP/01	Straight
fos-fos-OP/02	Curved

Iris Forceps

Serrated, 114mm long

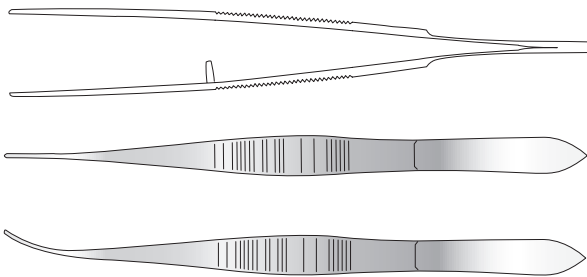

Code	Description
fos-OP/03	Straight
fos-OP/04	Curved

Iris Forceps

Extra fine, serrated, 94mm long

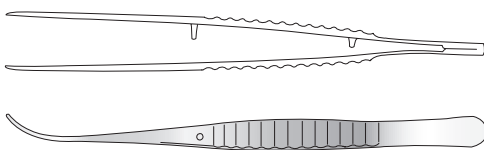

Code	Description
fos-OP/06	Curved

Iris Fixation Forceps

Extra fine, 1-2 teeth, 102mm long

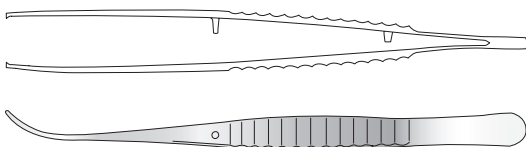

Code	Description
fos-OP/05	Curved

Barraquer Corneal Forceps

76mm long

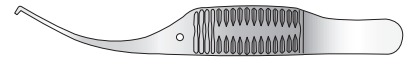

Code	Description
fos-OP/023	1-2 teeth

Epilation Forceps

89mm long

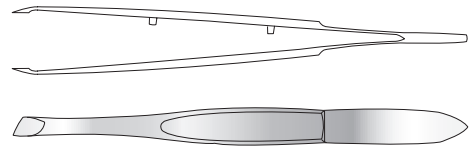

Code	Description
fos-OP/07	Oblique jaw

Epilation Forceps

89mm long

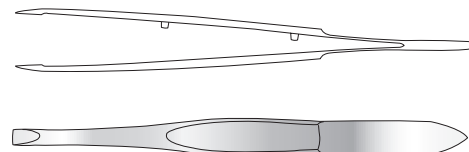

Code	Description
fos-OP/08	Straight ends, 3mm wide
fos-OP/08a	Round ends, 3mm wide

Suture/Dissecting Forceps

102mm long

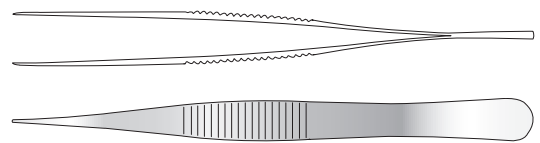

Code	Description
fos-OP/09	Extra fine

Barraquer Fixation Forceps

102mm long

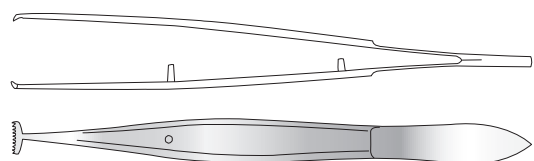

Code	Description
fos-OP/09a	9-10 teeth

Jameson Evans Cilia Forceps

120mm long

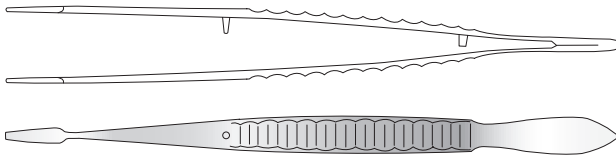

Code
fos-OP/012

Castroviejo Corneal Suture Forceps

94mm long

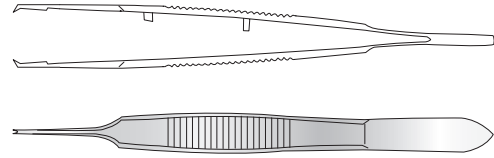

Code	Description
fos-OP/013	1-2 teeth

Tarsal Cyst Forceps

89mm long

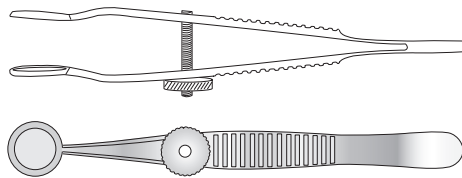

Code	Description
fos-OP/015	Round ends

Arruga Intra Capsule Forceps

For removal of residual lens material during extra-capsula extraction, 120mm long

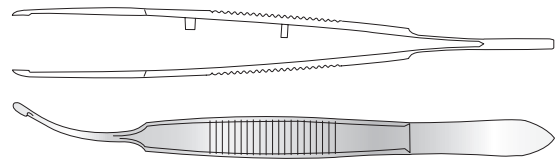

Code	Description
fos-OP/024	Curved tips

St Martin Corneal Suturing Forceps

1-2 teeth, 89mm long

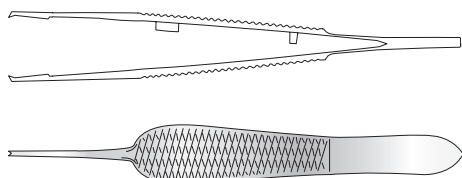

Code	Description
fos-OP/022	For fine work

Desmarre Entropian Forceps

89mm long

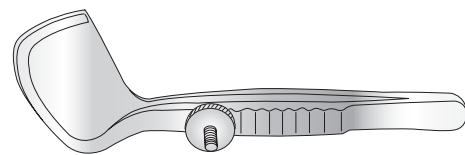

Code	Description
fos-OP/014	Right eye
fos-OP/014a	Left eye

St Martin Micro Corneal Suturing Forceps

1-2 teeth, 89mm long

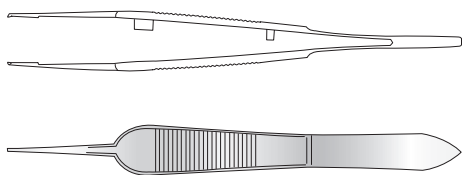

Code	Description
fos-OP/022a	Fine pattern

Wilde Entropian Forceps

3 sizes, 89mm long

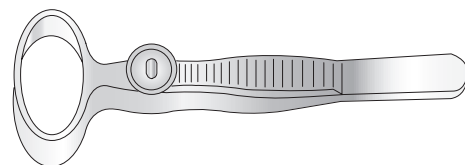

Code	Description
fos-OP/015a	With screw action

Scissors

i FOR INFORMATION ON BLACK AND GOLD BOWS SEE PAGE 23

de Wecker Iris Scissors

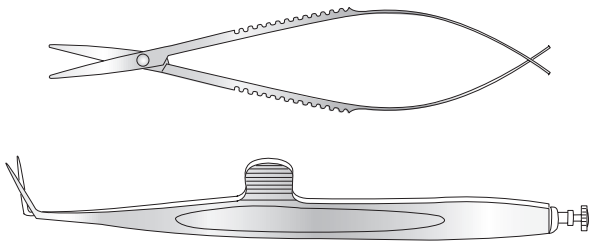

Code	Description
fos-OP/031	114mm long

Castroviejo Scissors

102mm long

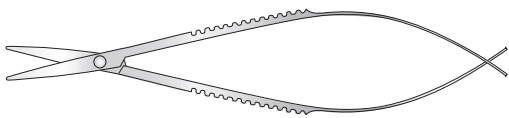

Code	Description
fos-OP/025	Curved

Barraquer Iris Scissors

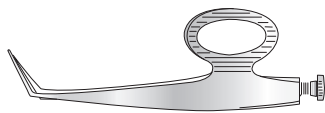

Code	Description
fos-OP/031a	62mm long

Iris Scissors

102mm long

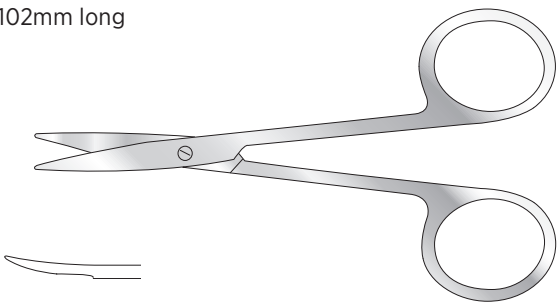

Code	Description
fos-OP/032	Straight
fos-OP/033	Curved

Pooley Conjunctival Scissors

89mm long

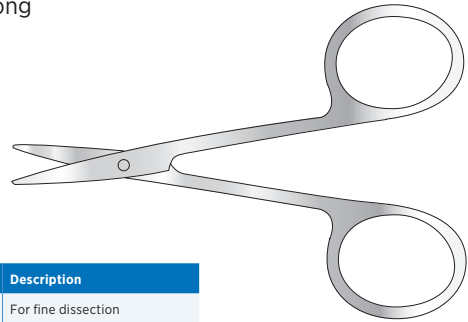

Code	Description
fos-OP/017	For fine dissection

Thomas Strabismus Scissors

114mm long

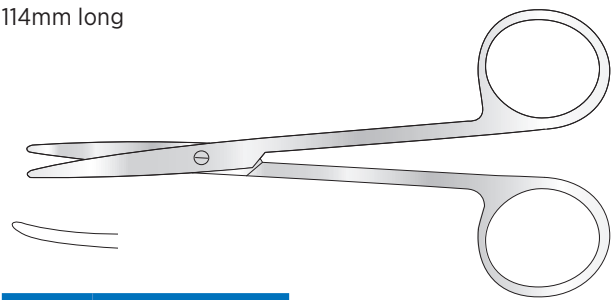

Code	Description
fos-OP/029	Straight
fos-OP/030	Curved

Strabismus Scissors

Supercut, 114mm long

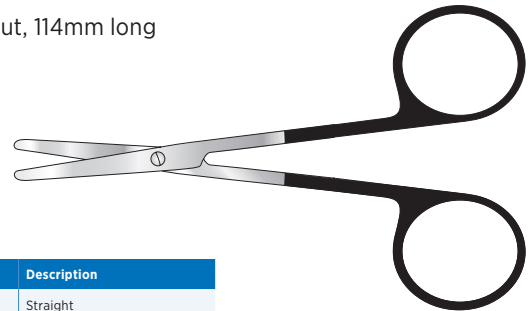

Code	Description
fos- £ 475	Straight
fos- £ 475a	Curved

Iris Scissors

Supercut, 114mm long

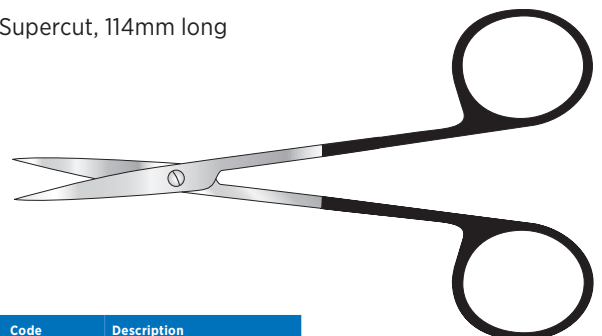

Code	Description
fos-OP/0476	Straight
fos-OP/0476a	Curved

Westcott Scissors

120mm long

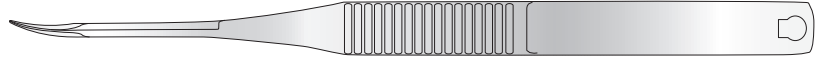

Code	Description
fos-OP/251	Curved, blunt
fos-OP/249	Curved, sharp
fos-OP/250	Straight, blunt
fos-OP/248	Straight, sharp

Vannas Scissors

Scissors

Code	Description
fos-OP/241	Blunt, curved 45°, 110mm
fos-OP/245	Curved 85mm
fos-OP/244	Straight 85mm
fos-OP/246	Strongly curved 85mm

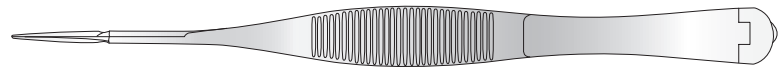

Micro Scissors

Code	Description
fos-OP/278	Delicate, straight, 85mm
fos-OP/280	Delicate, curved, 85mm
fos-OP/279	Delicate, strongly curved in plane, 85mm

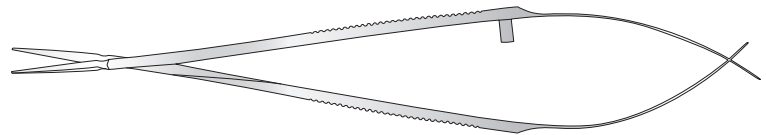

Needle Holders

Castroviejo Needle Holder

Code	Description
fos-OP/021	140mm long, with catch
fos-OP/020	140mm long, without catch

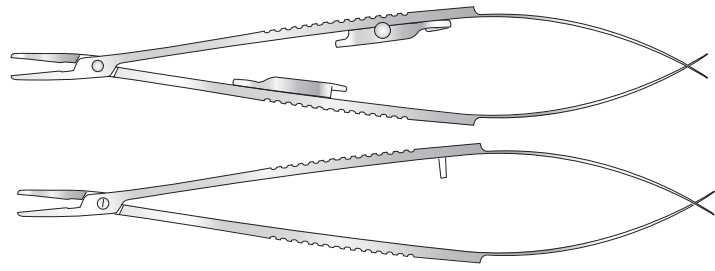

Diamond dust jaws

Code	Description
fos-TB/060	180mm long, without catch
fos-TB/061	200mm long, without catch
fos-TB/062	215mm long, without catch



ALSO AVAILABLE WITH CATCH - ADD SUFFIX CTH TO CODE

Tungsten carbide jaws

Code	Description
fos-TB/058a	180mm long
fos-TB/058	200mm long
fos-TB/059	215mm long

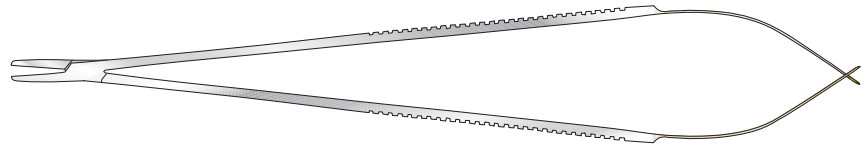

ALSO AVAILABLE WITH CATCH - ADD SUFFIX CTH TO CODE

Silcock Needle Holder

140mm long

Code	Description
fos-OP/21a	With catch
fos-OP/20	Without catch

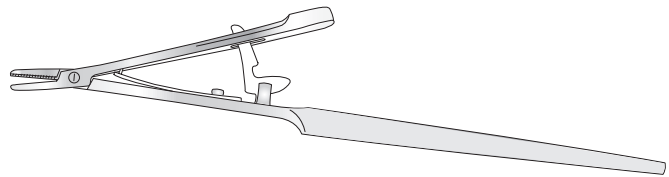

Micro Needle Holder

Round knurled handle, 120mm long

Code	Description
fos-OP/YA020	Curved, without catch
fos-OP/YA050	Curved, with catch
fos-OP/WA010	Straight, without catch

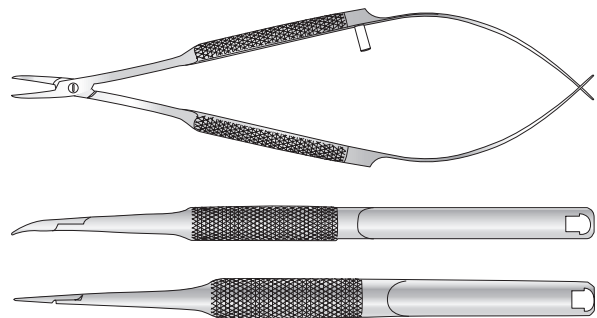

Micro Needle Holder

Curved, without catch

Code	Description
fos-OP/YA010	110mm long

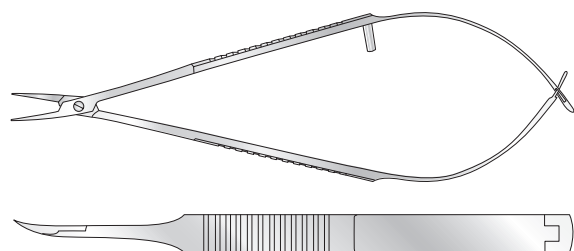

Retractors, Speculums and Cannulas

Lang Eyelid Retractor

76mm long

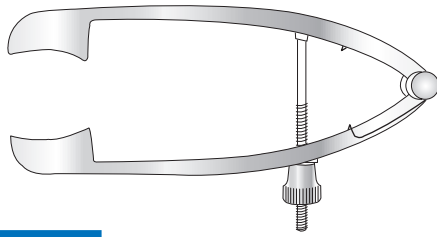

Code	Description
fos-OP/011b	Left eye
fos-OP/011c	Right eye

Desmarre Eyelid Retractor

Single, 140mm long



Code	Description
fos-OP/013	12.7mm wide blade
fos-OP/014	15.9mm wide blade
fos-OP/015	19mm wide blade

Barraquer Eye Speculum

Stainless steel wire, 44mm long

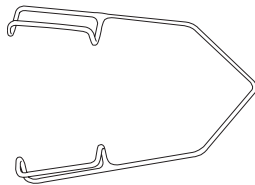

Code	Description
fos-OP/006	Standard
fos-OP/007	Small

Speculum

Wire, 30mm wide x 45mm long

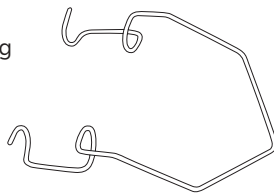

Code	Description
fos-OP/8004012	Titanium
fos-OP/8004012ss	Stainless

Speculum

Wire, 25mm wide x 40mm long

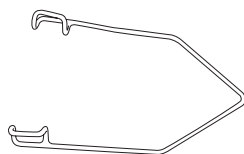

Code	Description
fos-OP/8004013	Titanium
fos-OP/8004013ss	Stainless

Speculum

Wire, 20mm wide x 30mm long

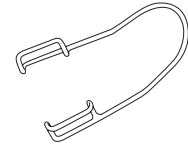

code	Description
fos-OP/8004013a	Titanium
fos-OP/8004013a-ss	Stainless

Clark Speculum

Wire, 35mm wide x 84mm long

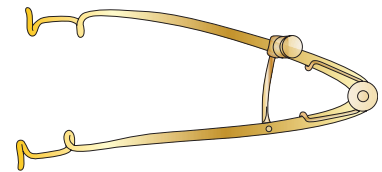

Code	Description
fos-S/5746	
fos-S/5746L	Infant - left
fos-S/5746R	Infant - right

Lang Lachrymal Cannula

38mm long

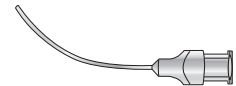

Code	Description
fos-OP/026	Cannula = 1mm ø

Cannula

Curved, 44mm long



Code	Description
fos-OP/026	Flat ended

Harrison Butler Lachrymal Cannula

38mm long



Code	Description
fos-OP/027	Cannula = 0.6mm ø

Miscellaneous

Spring Bag Clip

Serrated

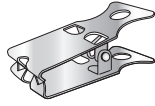

Code	Description
fos- E 345	26mm wide

Castroviejo Calliper

89mm long

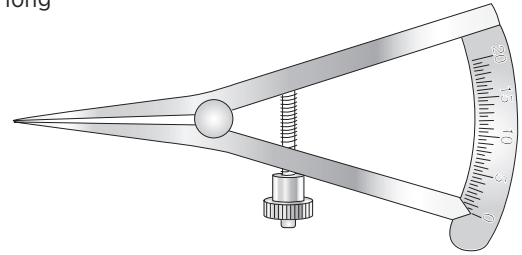

Code	Description
fos-OP/028	Stainless
fos-OP/8006007	Titanium

Graefe Knife

127mm long

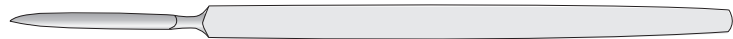

Code
fos-OP/010

Tooke Knife

122mm long



Code	Description
fos-OP/035	6 sizes

Chalazian Sharp Spoons

122mm long

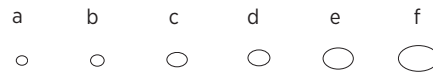

Code	Description
fos-OP/034	6 sizes

Snellen Vectis

Blunt, long loop, 140mm long



Code	Description
fos-OP/018	Straight
fos-OP/019	Angled



Orthopaedic

Bone Cutting Forceps	140
Bone Rongeurs	141
Bone Holding Forceps	144
Bone Holding Clamps	146
Plaster Spreaders and Shears	147
Bone Curettes	148
Bone Levers	153
Retractors	154
Dissecting Forceps and Hooks	156
Raspatories, Burr and Rugines	157
Osteotomes, Chisels and Gouges	158
Wire Cutters and Pliers	161
Accessories	164
Mallets	165
Raspatories, Files and Punches	167
Pushers, Impactors and Skids	168
Elevators	169
Retractors and Bone Levers	172
Saws, Shears and Knives	173
Screw and Plate Instruments	173
Pins	174
Sterile Kirschner and Arthrodesis Wires	175
Extremities Instruments and Sets	176
Shoulder Instruments	178

Bone Cutting Forceps

McIndoe Bone Cutting Forcep

Lightweight, compound action, angled jaw with prismatic points

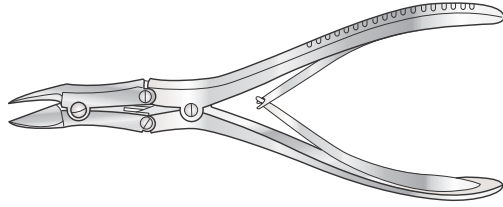

Code	Description
fos-OR/13b	165mm long
fos-OR/13c	191mm long

Liston Box Joint Bone Cutting Forcep

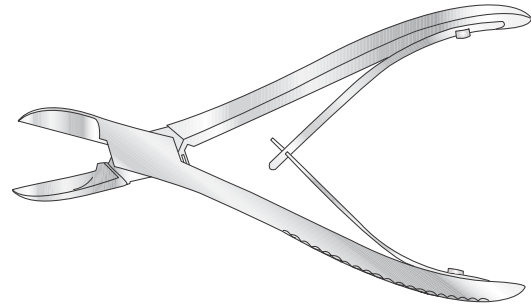

Straight

Code	Description
fos-OR/032	140mm long
fos-OR/033	200mm long
fos-OR/027	220mm long

Angled

Code	Description
fos-OR/061	170mm long
fos-OR/062	220mm long

Liston Screw Joint Bone Cutting Forcep

With fluted handle

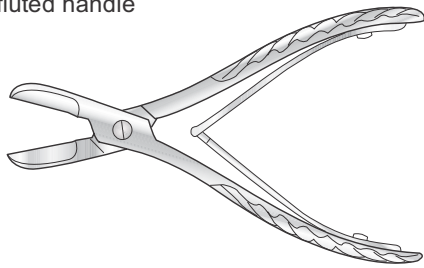

150mm long

Code	Description
fos-OR/24	Straight
fos-OR/24a	Angled

200mm long

Code	Description
fos-OR/26	Straight

180mm long

Code	Description
fos-OR/25	Straight
fos-OR/25a	Angled

230mm long

Code	Description
fos-OR/27	Straight

Screw Joint Bone Cutting Forcep

Straight

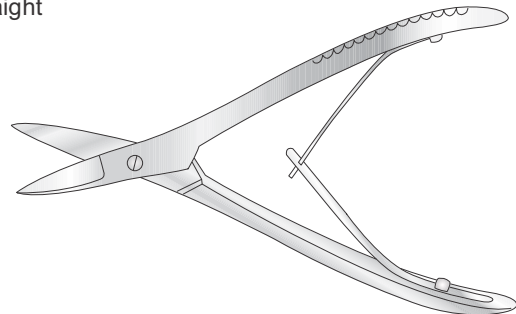

Code	Description
fos-OR/030	160mm long

Liston Compound Action Bone Cutting Forcep

Straight, for heavy duty

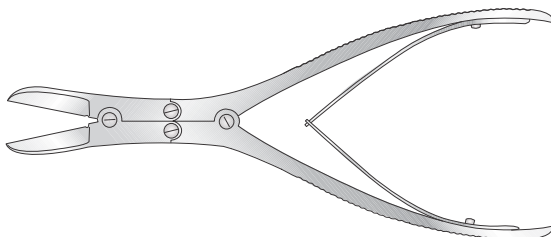

Code	Description
fos-OR/27a	305mm long
fos-OR/27b	300mm long
fos-OR/27c	190mm long

Ruskin-Liston Bone Cutting Forcep

Compound action, fine

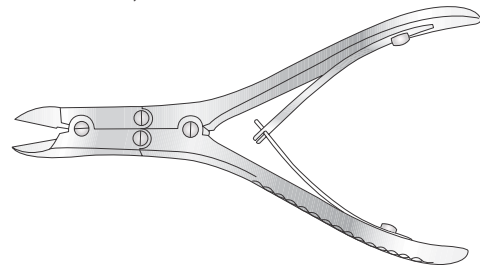

Straight

Code	Description
fos-OR/057	140mm long
fos-OR/074	145mm long
fos-OR/073	190mm long

Angled

Code	Description
fos-OR/063	190mm long

Bone Cutting Forceps and Bone Rongeur

Ward Bone Cutting Forceps

Slightly angled on flat

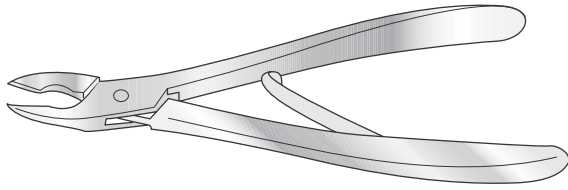

Code	Description
fos-GI/459	180mm long

Kleinert Kutz Bone Rongeur

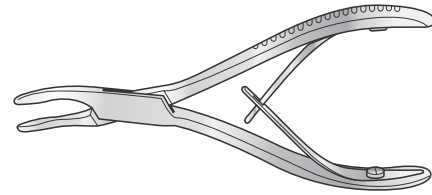

Code	Description
fos-OR/009a	Curved, 140mm, width 2mm
fos-OR/009	Curved, 155mm, width 2mm
fos-OR/011	Curved, 155mm, width 3mm

Horsley Compound Action Bone Cutter

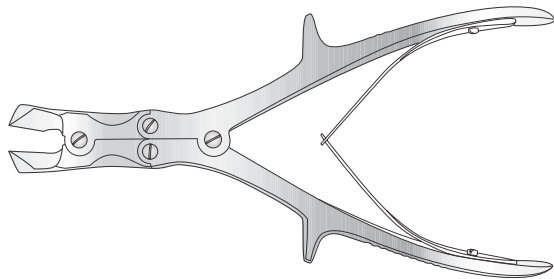

Code	Description
fos-OR/002	235mm long

Kleinert Kutz Skin Hooks



Code	Description
fos-PL/109	16cm large
fos-PL/108	16cm medium
fos-PL/107	16cm small

Stamms Box Joint Bone Cutter

Standard, stainless steel

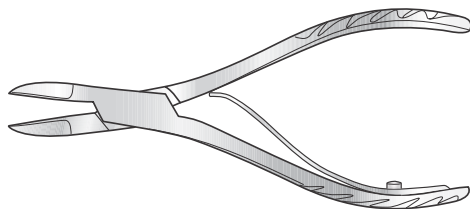

Code	Description
fos-OR/N056	140mm long

Bone Rongeurs

Echlin Compound Action Bone Rongeur

Straight, with or without horn, 230mm long

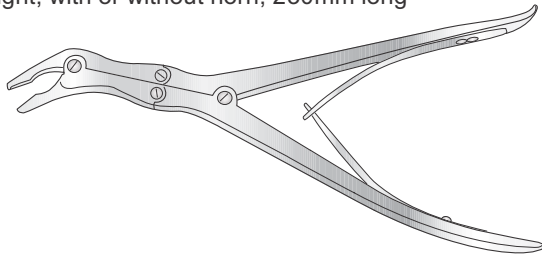

Code	Description
fos-OR/005	Width 2mm
fos-OR/006	Width 3mm
fos-OR/007	Width 4mm

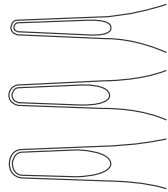

Stille Compound Action Bone Rongeur

Angled to side, 240mm long

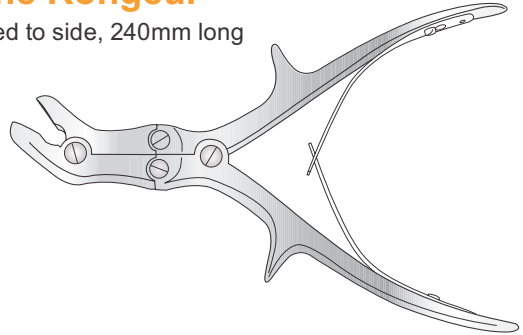

Code	Description
fos-OR/037	11mm bite

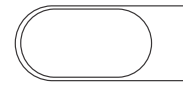

Leksell Compound Action Bone Rongeur

250mm long

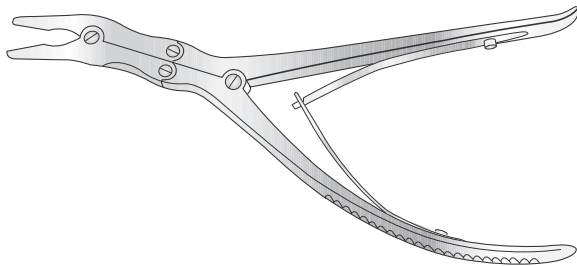

Code	Description
fos-OR/066	3mm bite
fos-OR/069	5mm bite
fos-OR/065	8mm bite

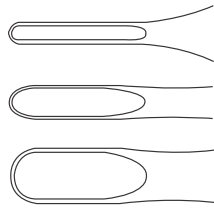

Leksell Stille Compound Action Bone Rongeur

240mm long

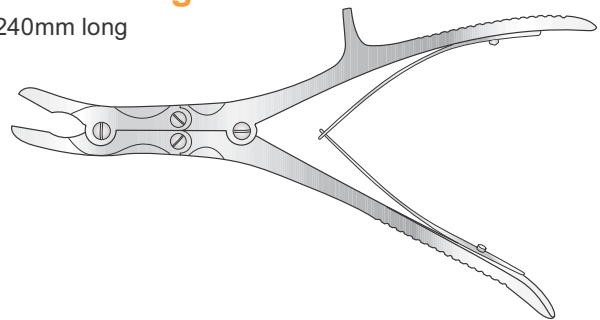

Code	Description
fos-OR/065a	8mm bite



Leksell Compound Action Bone Rongeur

240mm long

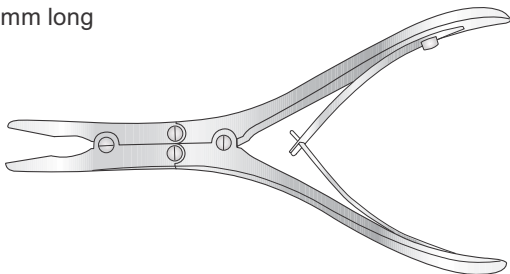

Code	Description
fos-OR/008	Width 3mm



Luer Stille Compound Action Bone Rongeur

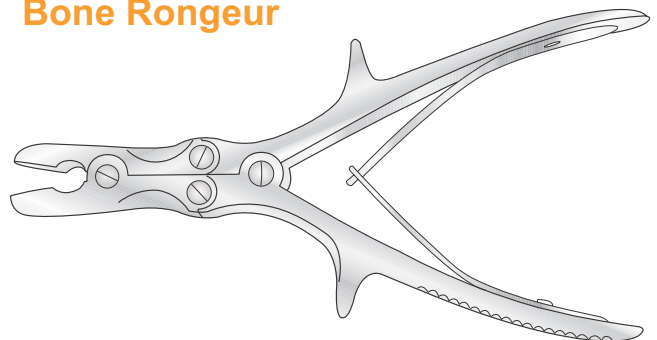

Straight

Code	Description
fos-OR/071	10mm bite, 220mm long
fos-OR/072	12mm bite, 260mm long

Curved

Code	Description
fos-OR/071a	10mm bite, 220mm long
fos-OR/071b	11mm bite, 230mm long

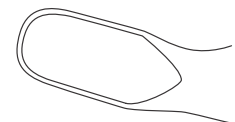

Luer Compound Action Bone Rongeur

6mm bite, 190mm long

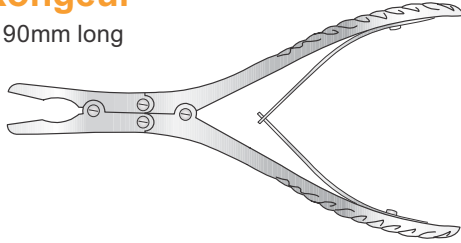

Code	Description
fos-OR/13	Straight
fos-OR/13a	Curved

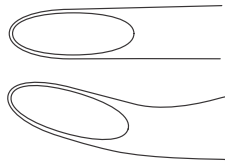

Ruskin Compound Action Bone Rongeur

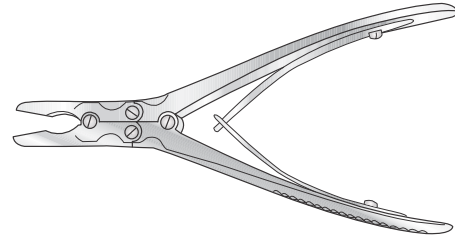

3mm bite, 150mm long

4mm bite, 185mm long

Code	Description
fos-OR/034	Straight
fos-OR/035	Curved

Code	Description
fos-OR/028	Straight
fos-OR/036	Curved

Luer Box Joint Bone Rongeur

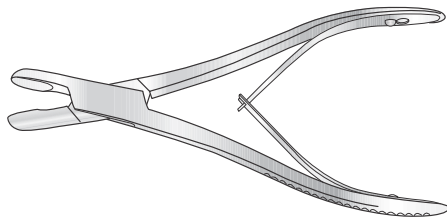

Straight, 185mm long

Curved, 210mm long

Code	Description
fos-OR/031	8mm bite
fos-OR/041	10mm bite

Code	Description
fos-OR/042	8mm bite

Compound Action Bone Rongeur

Lightweight pattern, curved, 150mm long

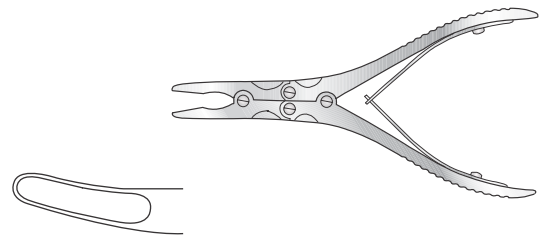

Code	Description
fos-OR/013d	4mm bite

Cushing Screw Joint Bone Rongeur

190mm long

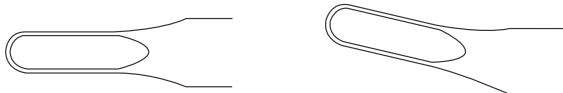
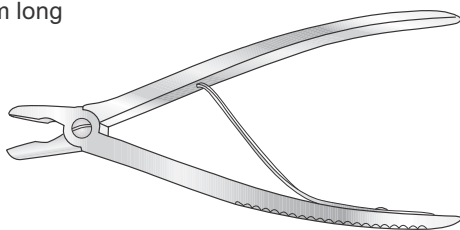

Straight

Curved

Code	Description
fos-OR/039	4mm bite
fos-OR/058	6mm bite
fos-OR/059	8mm bite

Code	Description
fos-OR/060	4mm bite
fos-OR/067	6mm bite
fos-OR/068	8mm bite

Lempert Box Joint Bone Rongeur

3mm bite, 155mm long

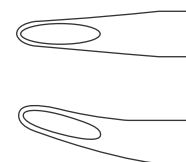
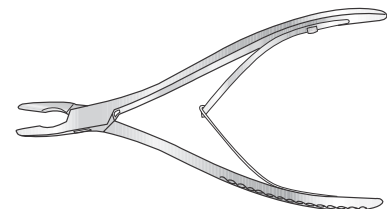

Code	Description
fos-OR/327	Straight
fos-OR/010	Curved

Bone Holding Forceps

Lambotte Bone Holding Forceps

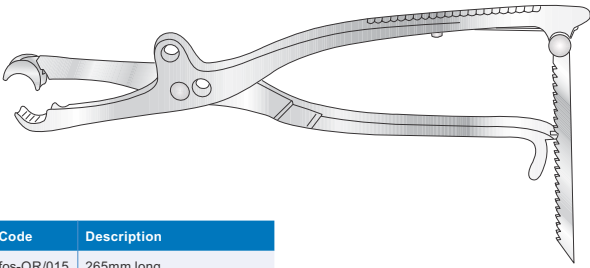

Code	Description
fos-OR/015	265mm long

Bone Holding Forceps

Screw joint, with holding screw

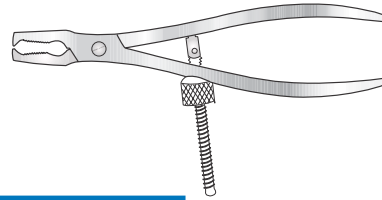

Code	Description
fos-OR/029	165mm long

Lambotte Bone Holding Forceps

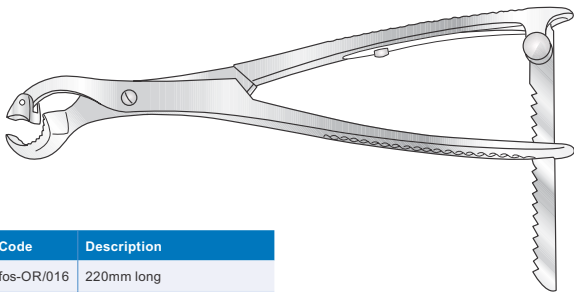

Code	Description
fos-OR/016	220mm long
fos-OR/017	215mm long
fos-OR/022	330mm long

Hey Groves Bone Holding Forceps

With screw locking device



Code	Description
fos-OR/29d	200mm long
fos-OR/29e	225mm long
fos-OR/29f	305mm long

Farabeuf Bone Holding Forceps

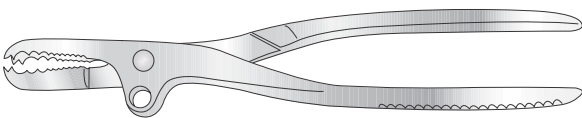

Code	Description
fos-OR/021	230mm long
fos-OR/328	250mm long

Bone Holding Forceps

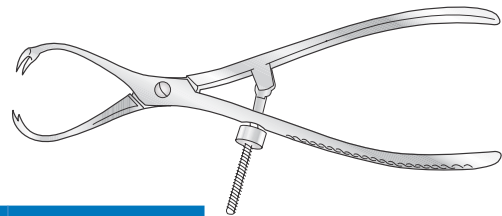

Code	Description
fos-OR/13	140mm long
fos-OR/014	185mm long
fos-OR/018	215mm long
fos-OR/019	275mm long

Farabeuf-Lambotte Bone Holding Forceps

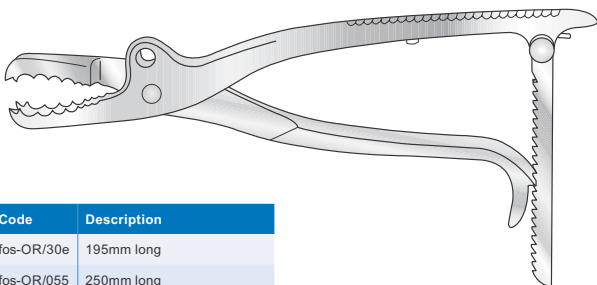

Code	Description
fos-OR/30e	195mm long
fos-OR/055	250mm long
fos-OR/30f	260mm long

Fergusson Bone Holding Forceps

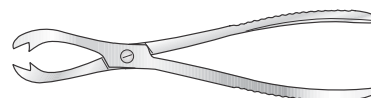

Code	Description
fos-OR/30	150mm long
fos-OR/30a	200mm long
fos-OR/30b	230mm long

Frosch Bone Holding Forceps

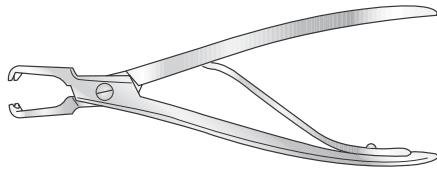

Code	Description
fos-OR/N061	180mm long

Sequestrum (Necrosis) Forcep

Straight, long fine jaws

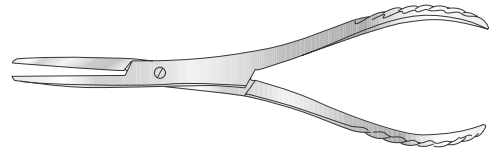

Code	Description
fos-OR/SEQ001	191mm long
fos-OR/SEQ002	203mm long

Joint Calcaneal Spreader

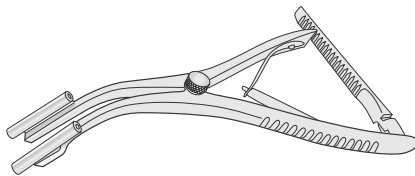

Code	Description
fos-OR/CAL001	40mm opening, 1.6mm ø, 170mm long

Calcaneal Spreader

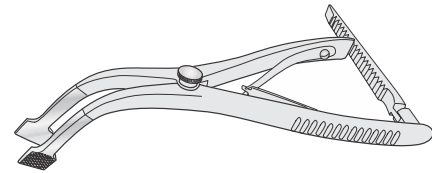

Code	Description
fos-OR/CAL002	40mm opening, 15mm wide tip, 70mm long

Inge Type Lamina Spreader

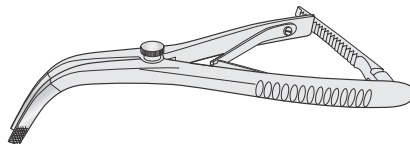

Code	Description
fos-OR/CAL003	40mm opening, no teeth, 5mm wide tip, 170mm long

Inge Type Lamina Spreader

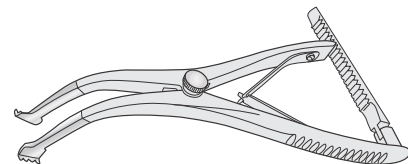

Code	Description
fos-OR/CAL004	Baby, 40mm opening, with teeth, 10mm wide tip, 160mm long
fos-OR/CAL004a	50mm opening, with teeth, 10mm wide tip, 240mm long

Harrison Bone Holding Forceps

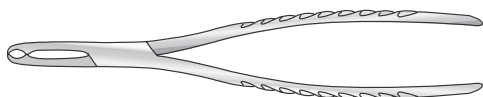

Code	Description
fos-OR/30d	190mm long

St Thomas Bone Holding Forceps

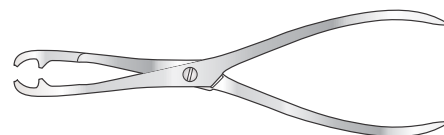

Code	Description
fos-OR/403c	182mm long

Bone Holding Forceps and Clamps

Burns Bone Holding Forceps

Box joint

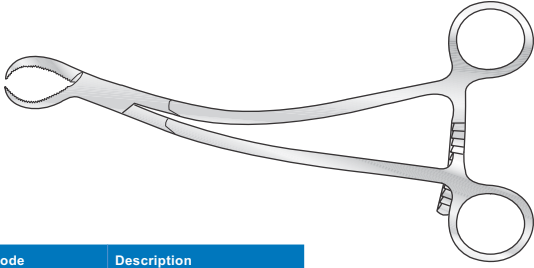

Code	Description
fos-OR/29a	200mm long

Scarf Type Clamp

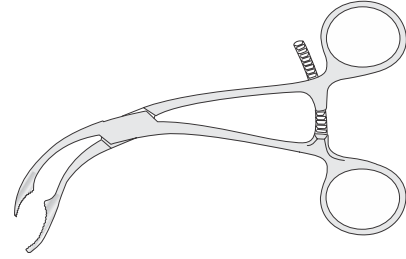

Code	Description
fos-OR/SCA	150mm long

Orthopaedic Grasping Forceps

Box joint

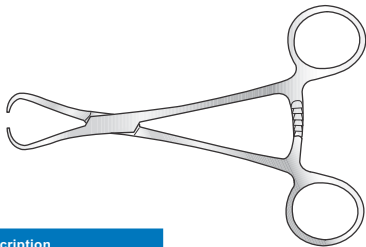

Code	Description
fos-OR/29b	125mm long
fos-OR/29c	165mm long

Lowman Bone Holding Clamp

Infant 125mm long
Child 175mm long
Adult 205mm long

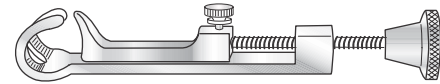

Code
fos-OR/28

Reduction Forcep

With adjustable lock

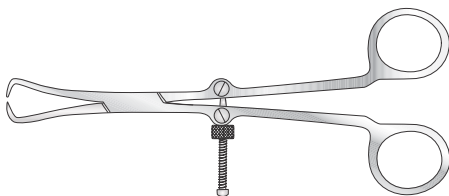

Code	Description
fos-OR/RED001a	Small, 135mm long
fos-OR/RED001b	Large, 168mm long

Parker Modified Lowman Bone Holding Clamp, Single

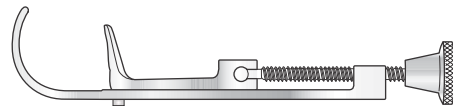

Code	Description
fos-OR/5644	160mm long

Verbrugge Bone Holding Forceps

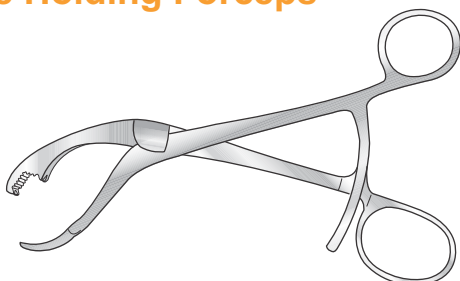

Code	Description
fos-OR/30c	180mm long

Parker Retractor

For use with Lowman clamp

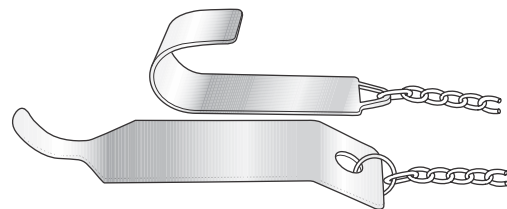

Code	Description
fos-OR/5643	Chain 850mm long

Haglund Plaster Spreader

Working part curved in right

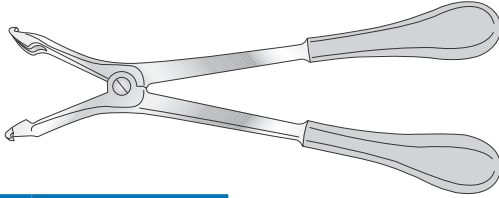

Code	Description
fos-OR/207	280mm long

Plaster Cutter

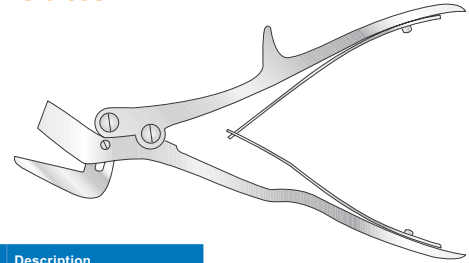

Code	Description
fos-OR/40	240mm long

Lawton Plaster Spreader

Working part curved in right

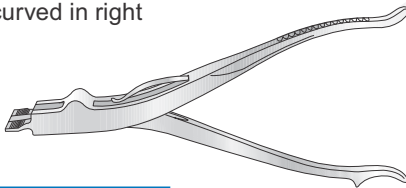

Code	Description
fos-OR/208	220mm long

Bohler Plaster Shears

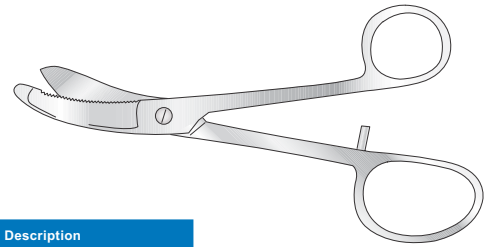

Code	Description
fos-OR/38	240mm long

Henning Plaster Spreader

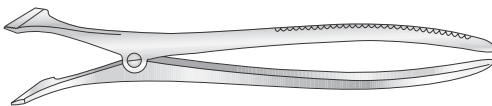

Code	Description
fos-OR/211	270mm long

Guys Plaster Shears



Code	Description
fos-OR/39	240mm long

Wolf Plaster Spreader

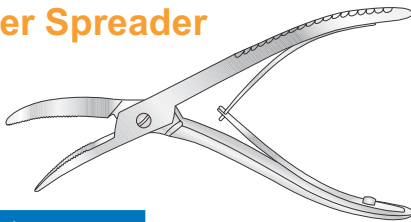

Code	Description
fos-OR/212	180mm long
fos-OR/329	250mm long

Engel Plaster Saw

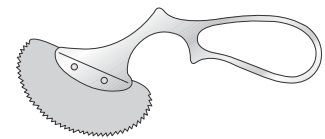

Code	Description
fos-OR/40b	150mm long

Stille Type Plaster Shears

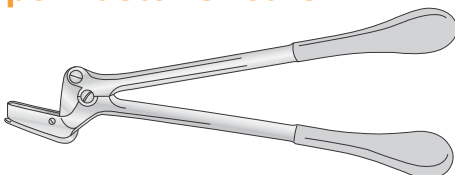

Code	Description
fos-OR/210	380mm long
fos-OR/210a	330mm long
fos-OR/210b	460mm long

Eccentric Plaster Shears

Without heavy serrated blade

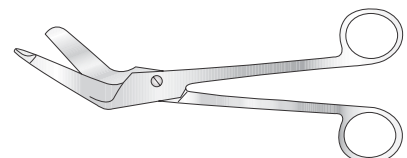

Code	Description
fos-OR/40a	190mm long

Bone Curettes

Bone Curette

Straight, 180mm long

Code	Description	Code	Description
fos-OR/075	Width 2mm	fos-OR/079	Width 10mm
fos-OR/076	Width 4mm	fos-OR/080	Width 12mm
fos-OR/077	Width 6mm	fos-OR/081	Width 14mm
fos-OR/078	Width 8mm	fos-OR/082	Width 16mm

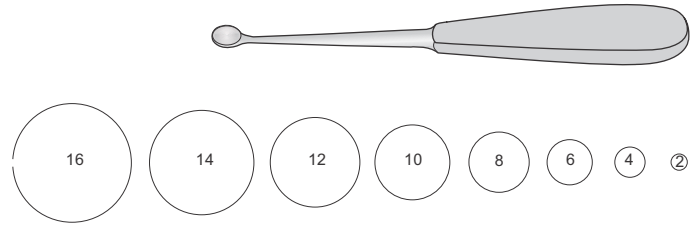

Bone Curette

Straight, 260mm long

Code	Description	Code	Description
fos-OR/083	Width 2mm	fos-OR/086	Width 8mm
fos-OR/084	Width 4mm	fos-OR/087	Width 10mm
fos-OR/085	Width 6mm	fos-OR/088	Width 12mm

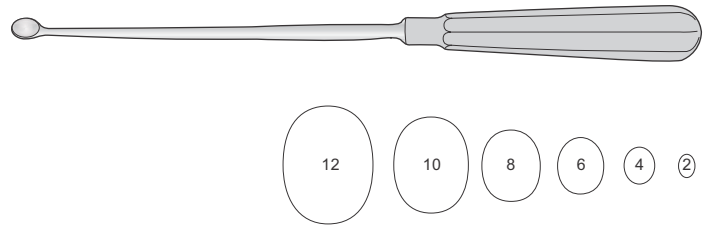

Bone Curette

Straight, 210mm long

Code	Description
fos-OR/089	Width 2mm
fos-OR/090	Width 4mm
fos-OR/091	Width 6mm
fos-OR/092	Width 8mm
fos-OR/093	Width 10mm
fos-OR/094	Width 12mm
fos-OR/095	Width 14mm
fos-OR/096	Width 16mm
fos-OR/097	Width 20mm

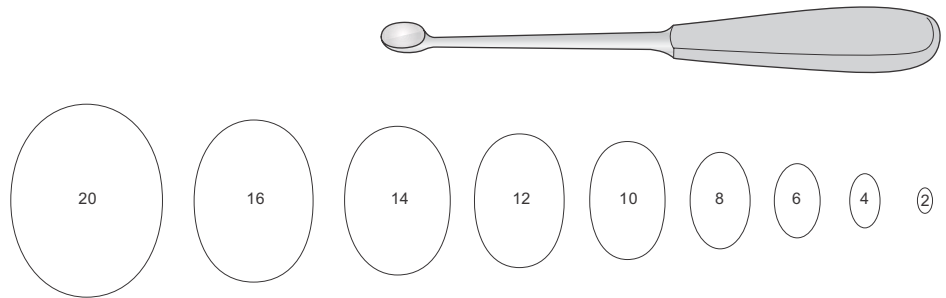

Busche Bone Curette

Angled, 250mm long

Code	Description
fos-OR/138	Width 3mm
fos-OR/139	Width 4mm
fos-OR/140	Width 5mm

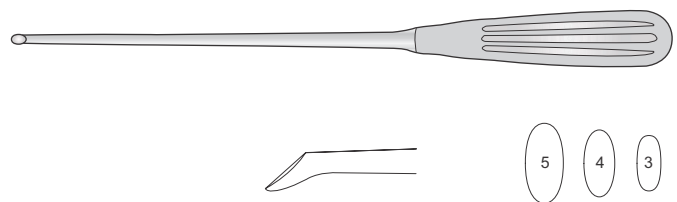

Bruns Bone Curette

225mm long

Straight

Code	Description
fos-OR/189	Width 3mm
fos-OR/190	Width 4mm
fos-OR/191	Width 5mm
fos-OR/192	Width 6mm
fos-OR/193	Width 7mm
fos-OR/194	Width 8mm

Angled

Code	Description
fos-OR/195	Width 3mm
fos-OR/196	Width 4mm
fos-OR/197	Width 5mm
fos-OR/198	Width 6mm
fos-OR/199	Width 7mm
fos-OR/200	Width 8mm

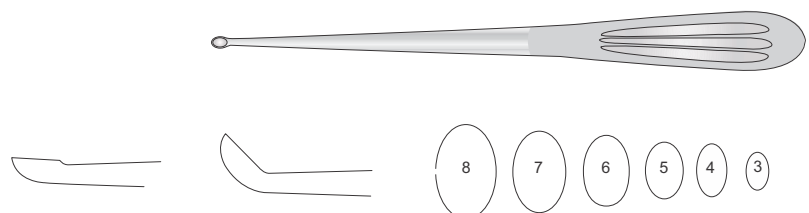

Gourdet Bone Curette

Straight, blunt
280mm long

Code	Description
fos-OR/157	Width 6mm
fos-OR/158	Width 8mm
fos-OR/159	Width 10mm
fos-OR/160	Width 12mm
fos-OR/161	Width 14mm

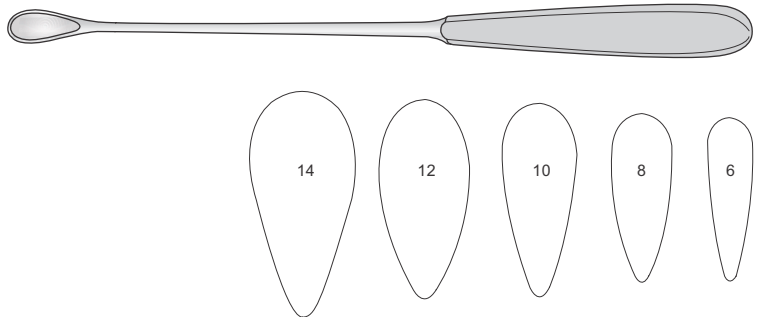

Shroeder Bone Curette

Straight, 310mm long

Code	Description
fos-OR/151	Width 6mm
fos-OR/152	Width 8mm
fos-OR/153	Width 10mm
fos-OR/154	Width 12mm
fos-OR/155	Width 14mm

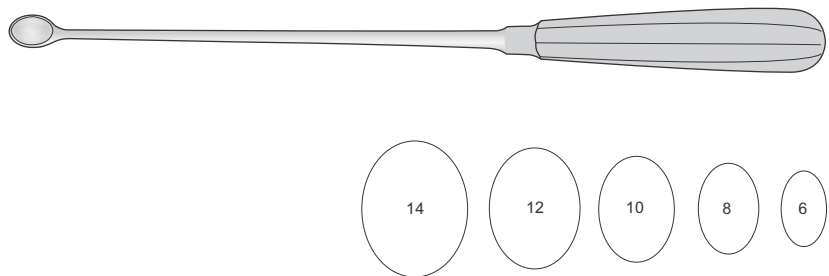

Simon Bone Curette

Straight, 240mm long

Code	Description
fos-OR/145	Width 6mm
fos-OR/146	Width 8mm
fos-OR/147	Width 10mm
fos-OR/148	Width 12mm
fos-OR/149	Width 14mm

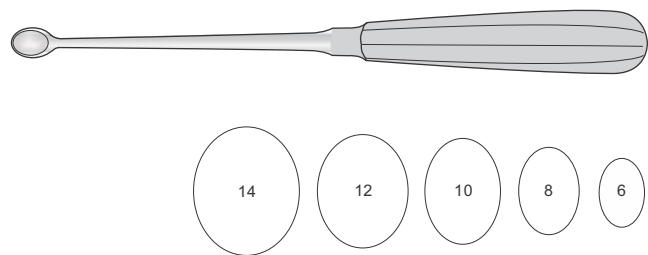

Spinal Curette

Oval, 205mm long

Code	Description	Code	Description
fos-OR/031a	Width 4mm	fos-OR/031e	Width 8mm
fos-OR/031b	Width 5mm	fos-OR/031f	Width 9mm
fos-OR/031c	Width 6mm	fos-OR/031g	Width 10mm
fos-OR/031d	Width 7mm	fos-OR/031h	Width 11mm

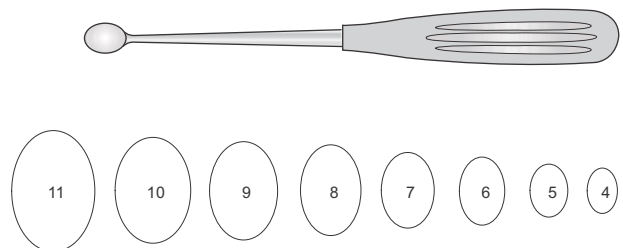

Bone Curettes

Volkman Bone Curette

Straight, 170mm long

Code	Description
fos-OR/112	Width 2mm
fos-OR/113	Width 3mm
fos-OR/114	Width 4mm
fos-OR/115	Width 5mm
fos-OR/116	Width 6mm

Code	Description
fos-OR/117	Width 8mm
fos-OR/118	Width 10mm
fos-OR/119	Width 12mm
fos-OR/120	Width 14mm

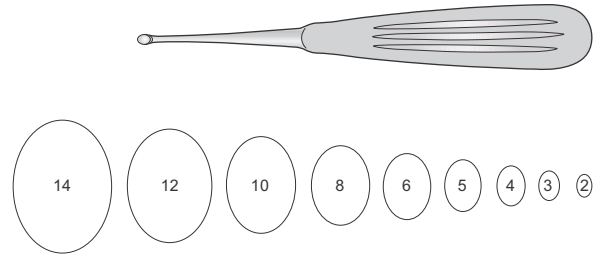

Volkman Bone Curette

Straight, 230mm long

Code	Description
fos-OR/SH.5687	Bowl width 10mm, bowl length 14.5mm



Wallich Bone Curette

Blunt

Code	Description
fos-OR/162	420mm long

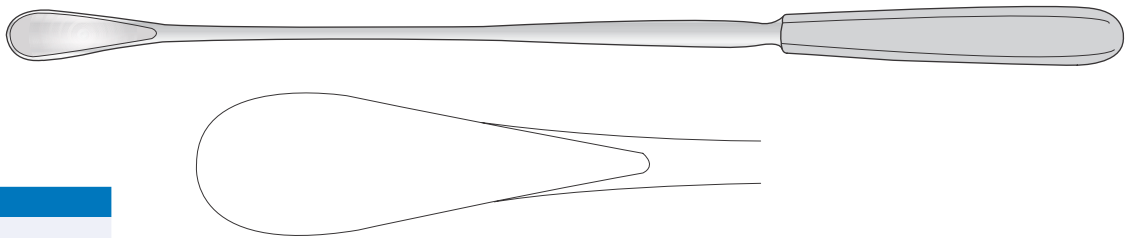

Williger Bone Curette

Straight, 170mm long

Code	Description
fos-OR/122	Width 3.5mm
fos-OR/123	Width 5.5mm



Charnley Bone Curette

With T handle,
380mm long

Code	Description
fos-OR/N040	Large, 20 x 14mm
fos-OR/N041	Medium, 17 x 12mm
fos-OR/N042	Small, 11 x 8mm

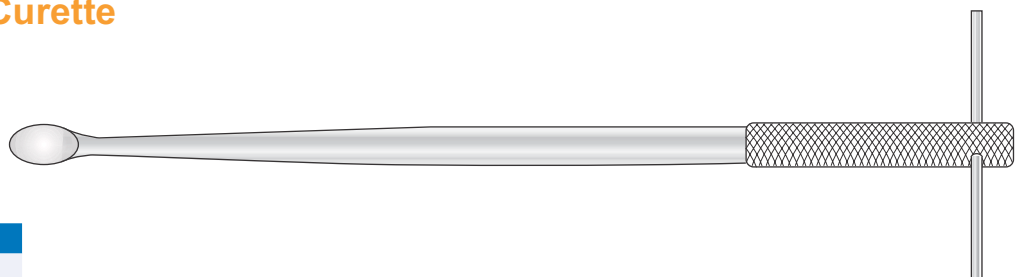

Sypert Bone Curette

Blue acetal "Suregrip" handle, 380mm long

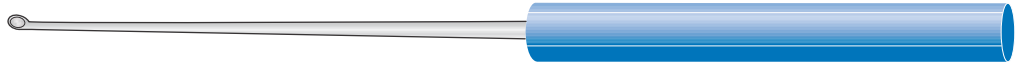

Straight

Code	Description
fos-OR/236	Width 3mm
fos-OR/237	Width 4mm
fos-OR/238	Width 5mm

Angled

Code	Description
fos-OR/240	Width 3mm
fos-OR/241	Width 4mm
fos-OR/245	Width 5mm



Bone Curette

Blue acetal "Suregrip" handle, 410mm long



Straight

Code	Description
fos-OR/249	Width 3mm
fos-OR/250	Width 4mm
fos-OR/251	Width 5mm

Angled

Code	Description
fos-OR/252	Width 3mm
fos-OR/253	Width 4mm
fos-OR/254	Width 5mm

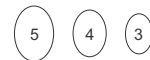

Caspar Bone Curette

Blue acetal "Suregrip" handle, 220mm long

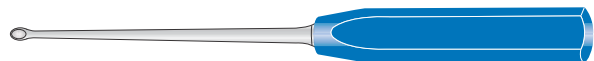

Straight

Code	Description
fos-OR/230	Width 3.5mm
fos-OR/231	Width 4.5mm
fos-OR/232	width 5.5mm

Angled

Code	Description
fos-OR/233	Width 3.5mm
fos-OR/234	Width 4.5mm
fos-OR/235	Width 5.5mm

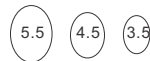

Bone Curette

Blue acetal "Suregrip" handle, 270mm long, straight

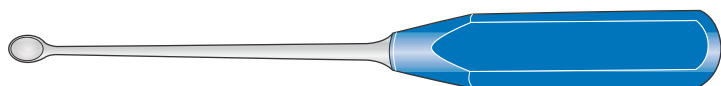

Code	Description
fos-OR/226	Width 4mm
fos-OR/227	Width 6mm
fos-OR/228	Width 8mm
fos-OR/229	Width 10mm

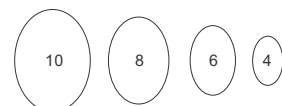

Bone Curettes

Capener Spoon

Blue acetal "Suregrip" handle 285mm long

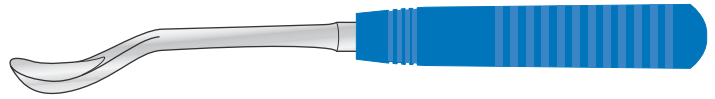

Code	Description
fos-OR/389a	Width 16mm
fos-OR/389b	Width 20mm

Capener Lamina Curette

Blue acetal "Suregrip" handle 300mm long



Code	Description
fos-OR/389c	12 x 32mm
fos-OR/389d	6 x 18mm

Stanley Boyd Curette

Double ended



Code	Description
fos-OR/162a	Small - 50mm long
fos-OR/162b	Medium - 200mm long
fos-OR/162c	Large - 250mm long

Volkman Bone Scoop

Double-ended, straight



Code	Description
fos-OR/31	175mm long
fos-OR/213	220mm long
fos-OR/175	220mm long

Martini Bone Curette

Shown at half size

double-ended, straight 140mm long



Code	Description
fos-OR/170	Small and medium
fos-OR/171	Medium and large

Lane Bone Lever

240mm long

6mm

Code	Description
fos-OR/N011	Slight curve
fos-OR/N012	Full curve

8mm

Code	Description
fos-OR/N013	Slight curve
fos-OR/N014	Full curve



Lane Bone Lever

For small bones

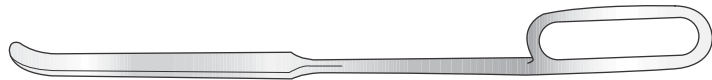

Code	Description
fos-OR/N015	10mm wide, 265mm long

Lane Bone Lever

For small bones, serrated end

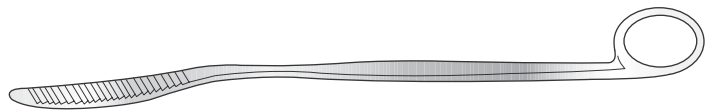

Code	Description
fos-OR/N016	10mm wide, 260mm long

Trethowan Bone Lever

Ring handle



Code	Description
fos-OR/N017	220mm long

Watson-Jones Bone Lever

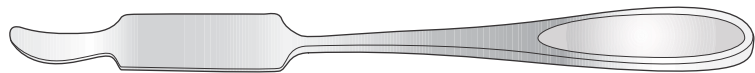

Code	Description
fos-OR/N054	275mm long

Bankhart Bone Lever



Code	Description
fos-OR/SH.5315	300mm long

Retractors

Hip Set

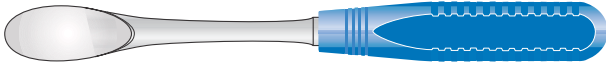

Femoral Dislocation Lever 285mm

Code	Description
fos-OR/N059A	Spoon elevator 25mm with blue acetal suregrip handle – large

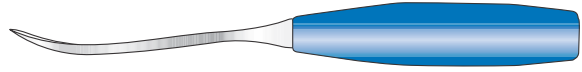

Curved Osteotome 260mm

Code	Description
fos-OR/N059D	With blue acetal suregrip handle - 2

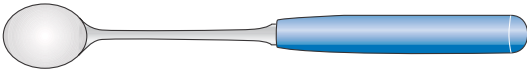

Muller Curette 240mm

Code	Description
fos-OR/N059B	Curette 27mm with blue acetal suregrip handle – large

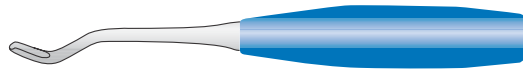

Small Gouge 240mm

Code	Description
fos-OR/N059E	8mm cranked blue acetal suregrip handle



Muller Curette 270mm

Code	Description
fos-OR/N059C	Curette 9mm with blue acetal suregrip handle – small

Charnley Initial Incision Retractor

Code	Description
fos-OR/N038a	Frame only
fos-OR/N038b	Weight only, 75mm x 50mm ø
fos-OR/N038s	Goal post pins and chain

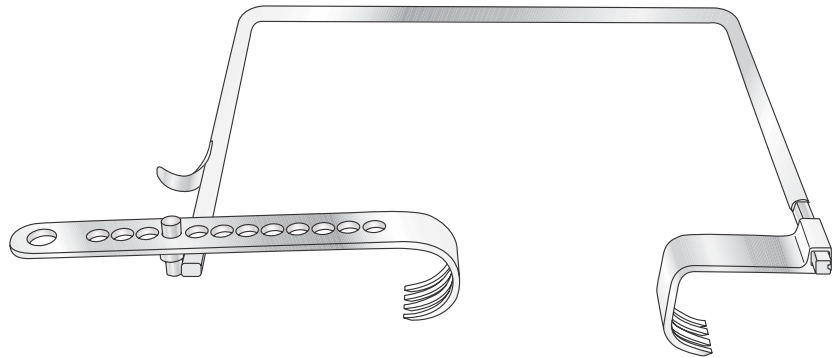

Short blades

Code	Description
fos-OR/N038r	Short blade, 25mm deep
SH006084	Short blade, 35mm deep
fos-OR/N038c	Short blade, 50mm deep
fos-OR/N038l	Short blade, 65mm
fos-OR/N038e	Short blade, 75mm deep
fos-OR/N038q	Short blade, 80mm deep
fos-OR/N038g	Short blade, 100mm deep
SH003879	Short blade, 125mm
SH003880	Short blade, 150mm

Long blades

Code	Description
SH006085	Long blade, 35mm deep
fos-OR/N038d	Long blade, 50mm deep
fos-OR/N038k	Long blade, 65mm
fos-OR/N038p	Long blade, 70mm deep
fos-OR/N038f	Long blade, 75mm deep
fos-OR/N038h	Long blade, 100mm deep
SH003877	Long blade, 125mm
SH003878	Long blade, 150mm
fos-OR/N038m	Long round blade, 50mm deep

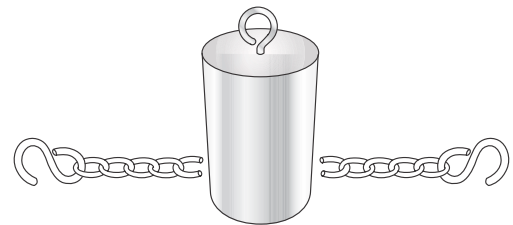

Travers Retractor

Self retaining, internal rack, 210mm long

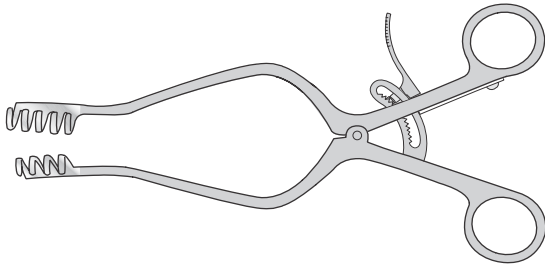

Code	Description
fos-GI/323	4 x 5 teeth, 95mm fully open

Jackson Burrows Retractor

Self retaining

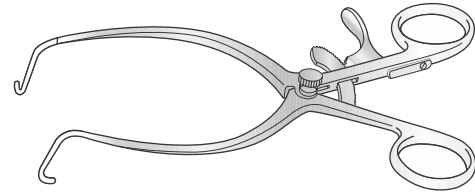

Code	Description
fos-GI/377	175mm

West Retractor

Self retaining, 140mm long

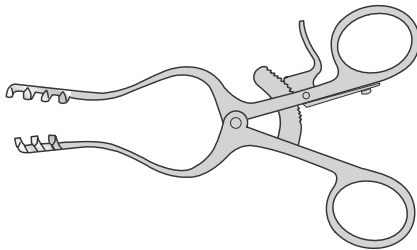

Code	Description
fos-GI/326	3 x 4 teeth, 60mm fully open
fos-GI/326cr	3 x 4 teeth, 60mm fully open, with cam rack

Norfolk and Norwich Retractor

4 x 5 teeth 50mm blades x 223mm long

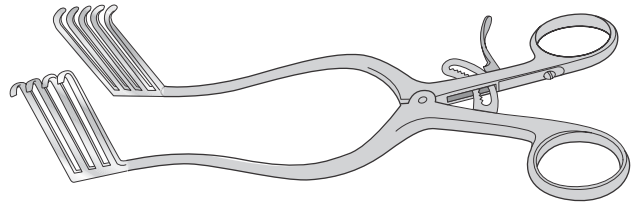

Code	Description
fos-GI/325	Standard rack

Retractors, Dissecting Forceps and Hooks

Jackson Burrows Hand Retractor

225mm long

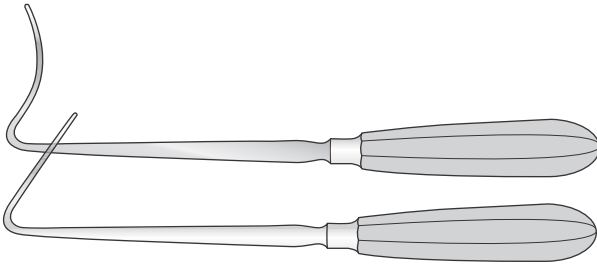

Code	Description
fos-OR/N050	Narrow curve, 13mm blade
fos-OR/N050a	Broad, angular, 20mm blade

Ballance (Volkman) Retractor

203mm long

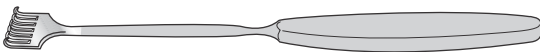

Sharp

Code	Description
fos-GI/463	1 prong
fos-GI/463a	2 prong
fos-GI/463b	3 prong
fos-GI/463c	4 prong
fos-GI/463d	6 prong

Blunt

Code	Description
fos-GI/463e	1 prong
fos-GI/463f	2 prong
fos-GI/463g	3 prong
fos-GI/463h	4 prong
fos-GI/463i	6 prong

Jackson Burrows Dissecting Forcep

140mm long

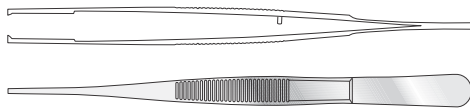

Code	Description
fos-OR/N037	Tongue and groove only
fos-OR/N037a	Tongue and groove, 1-2 teeth

Charnley-McIndoe Dissecting Forceps

150mm long

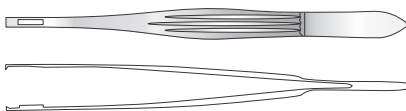

Code	Description
fos-OR/N045a	2-3 teeth

Kocher Bone Hook

220mm long

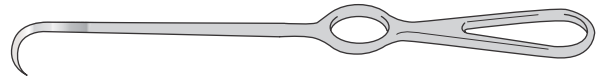

Code	Description
fos-OR/N036	Sharp
fos-OR/N036a	Blunt

Langenbeck Bone Hook

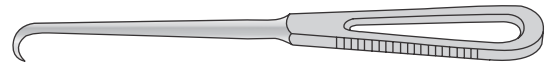

Code	Description
fos-OR/391	200mm long

Dislocation Hook

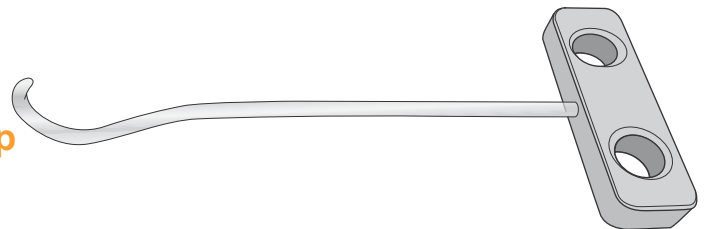

Code	Description
fos-OR/SH-5703	253mm long

Dislocation Hip Hook

Blue acetal "Suregrip" handle

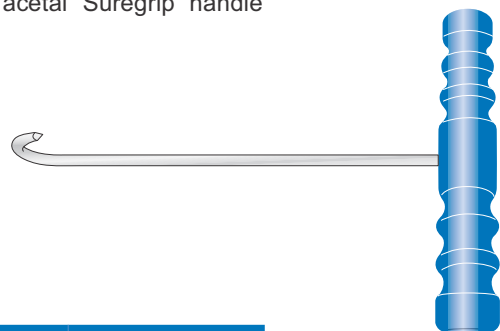

Code	Description
fos-OR/420	185mm long

Key Raspatories

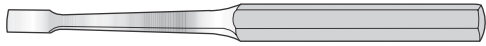

Code	Description
fos-OR/310	Width 6.4mm 180mm long
fos-OR/313	Width 9.5mm 190mm long
fos-OR/311	Width 12.7mm 190mm long
fos-OR/312	Width 19mm 200mm long
fos-OR/314	Width 25.4mm 210mm long

Lambotte Raspatory

205mm Long

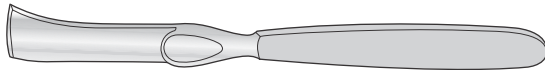

Code	Description
fos-OR/242	Width 10mm
fos-OR/243	Width 15mm
fos-OR/244	Width 20mm

Paton Bone Burr

Satin handle, 155mm long

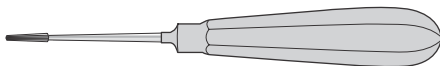

Code	Description
fos-OR/403	3.5mm ø x 17mm
fos-OR/403a	4.5mm ø x 17mm
fos-OR/403b	5.0mm ø x 17mm

Robert Jones Rugine

Convex sharp edge, fan shaped end, with solid pistol handle

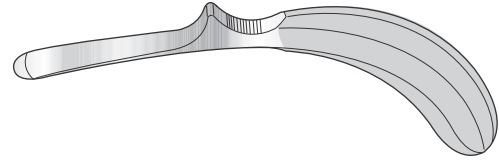

Code	Description
fos-OR/N035	185mm long

Mitchell Rugine

Straight, sharp edge, fan shaped, hollow handle

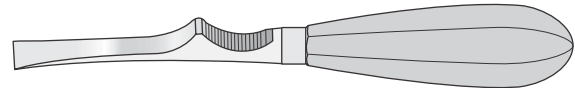

Code	Description
fos-OR/N034	210mm long

Farabeuf Rugine

Curved end, chisel edge, hollow handle

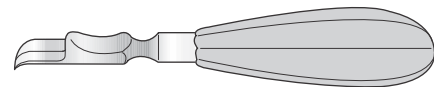

Code	Description
fos-OR/N033	160mm long

Osteotomes, Chisels and Gouges

Lexer Osteotome

Blue acetal "Suregrip" handle, 180mm long



Code	Description
fos-OR/SH5347a	4mm

Capener Lamina Gouge

Blue acetal "Suregrip" handle, straight, 265mm long

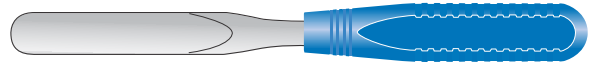

Code	Description
fos-OR/362	Width 6mm
fos-OR/363	Width 10mm
fos-OR/364	Width 12mm

Code	Description
fos-OR/365	Width 15mm
fos-OR/366	Width 20mm
fos-OR/367	Width 25mm

Capener Osteotome

Blue acetal "Suregrip" handle, 250mm long

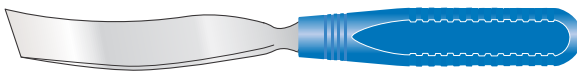

Shallow curved

Code	Description
fos-OR/384	Width 6mm
fos-OR/385	Width 10mm
fos-OR/386	Width 12mm
fos-OR/387	Width 15mm
fos-OR/388	Width 20mm
fos-OR/389	Width 25mm
fos-OR/390	Width 30mm

Acute curved

Code	Description
fos-OR/390a	Width 6mm
fos-OR/390b	Width 10mm
fos-OR/390c	Width 15mm
fos-OR/390d	Width 20mm
fos-OR/390e	Width 25mm

Capener Lamina Gouge

Cranked, blue acetal "Suregrip" handle, 250mm long

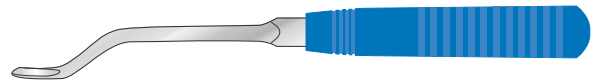

With reversed edge

Code	Description
fos-OR/373c	Width 6mm
fos-OR/373d	Width 8mm
fos-OR/373j	Width 10mm
fos-OR/373e	Width 11mm
fos-OR/373f	Width 16mm
fos-OR/373k	Width 17mm

Code	Description
fos-OR/373cre	Width 6mm
fos-OR/373dre	Width 8mm
fos-OR/373jre	Width 10mm
fos-OR/373ere	Width 11mm
fos-OR/373fre	Width 16mm
fos-OR/373kre	Width 17mm

OTHER LENGTHS AND SIZES AVAILABLE

Capener Osteotome

Blue acetal "Suregrip" handle, straight, 255mm long

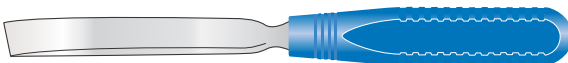

Code	Description
fos-OR/374	Width 6mm
fos-OR/375	Width 8mm
fos-OR/376	Width 10mm
fos-OR/377	Width 12mm
fos-OR/378	Width 13mm

Code	Description
fos-OR/379	Width 15mm
fos-OR/380	Width 18mm
fos-OR/381	Width 20mm
fos-OR/382	Width 25mm
fos-OR/383	Width 30mm

Capener Lamina Gouge

Swan neck, blue acetal "Suregrip" handle, 250mm long

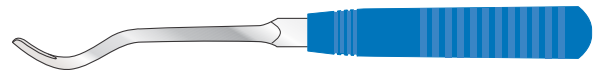

Code	Description
fos-OR/373g	Width 8mm

Capener Chisel

Blue acetal "Suregrip" handle straight, 250mm long

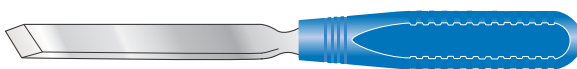

Code	Description
fos-OR/368	Width 6mm
fos-OR/369	Width 10mm
fos-OR/370	Width 12mm

Code	Description
fos-OR/371	Width 15mm
fos-OR/372	Width 20mm
fos-OR/373	Width 25mm

Capener Lamina Gouge

Reverse cranked, blue acetal "Suregrip" handle, 245mm long

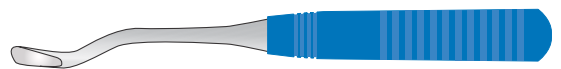

Code	Description
fos-OR/373ar	Width 11mm
fos-OR/373nr	Width 16mm
fos-OR/373jr	Width 17mm

Code	Description
fos-OR/3730r	Width 6mm
fos-OR/3731r	Width 8mm
fos-OR/373mr	Width 10mm

Read Osteotome

Serrated head
180mm long



Code	Description
fos-OR/335	Width 4mm
fos-OR/336	Width 5mm

Read Gouge

Serrated head, 180mm long



Code	Description
fos-OR/344	Width 2mm
fos-OR/345	Width 3mm
fos-OR/346	Width 4mm
fos-OR/347	Width 5mm

Code	Description
fos-OR/341	Width 6mm
fos-OR/342	Width 7mm
fos-OR/343	Width 8mm

Read Chisel

Serrated head, 180mm long



Code	Description
fos-OR/337	Width 2mm
fos-OR/338	Width 3mm
fos-OR/339	Width 4mm
fos-OR/340	Width 5mm

Code	Description
fos-OR/341	Width 6mm
fos-OR/342	Width 7mm
fos-OR/343	Width 8mm

Swedish Pattern Osteotome

200mm long

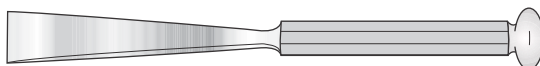

Code	Description
fos-OR/348	Width 10mm
fos-OR/349	Width 15mm
fos-OR/350	Width 20mm
fos-OR/351	Width 25mm
fos-OR/352	Width 30mm

With tungsten carbide edge

Code	Description
fos-OR/348tc	Width 10mm
fos-OR/349tc	Width 15mm
fos-OR/350tc	Width 20mm
fos-OR/351tc	Width 25mm
fos-OR/352tc	Width 30mm

Swedish Pattern Chisel

200mm long

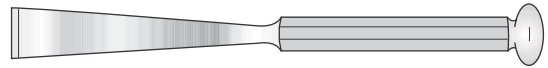

With tungsten carbide edge

Code	Description
fos-OR/353	Width 10mm
fos-OR/354	Width 15mm
fos-OR/355	Width 20mm
fos-OR/356	Width 25mm
fos-OR/357	Width 30mm

Code	Description
fos-OR/355tc	Width 20mm
fos-OR/356tc	Width 25mm
fos-OR/357tc	Width 30mm
fos-OR/356tc	Width 25mm
fos-OR/357tc	Width 30mm

Swedish Pattern Gouge

200mm long

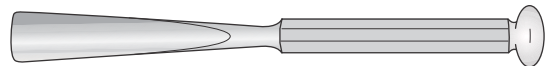

With tungsten carbide edge

Code	Description
fos-OR/358	Width 10mm
fos-OR/359	Width 15mm
fos-OR/360	Width 20mm
fos-OR/361	Width 25mm

Code	Description
fos-OR/358tc	Width 10mm
fos-OR/359tc	Width 15mm
fos-OR/360tc	Width 20mm
fos-OR/361tc	Width 25mm

Lambotte Osteotome

230mm long



Straight

Code	Description
fos-OR/392	2mm wide
fos-OR/392a	4mm wide
fos-OR/392b	7mm wide
fos-OR/392c	15mm wide
fos-OR/392d	20mm wide
fos-OR/392e	25mm wide
fos-OR/392f	30mm wide
fos-OR/392g	38mm wide
fos-OR/392h	44mm wide
fos-OR/392i	50mm wide

Curved

Code	Description
fos-OR/392j	15mm wide
fos-OR/392k	20mm wide
fos-OR/392m	25mm wide
fos-OR/392n	30mm wide
fos-OR/392o	38mm wide
fos-OR/392p	40mm wide
fos-OR/392q	44mm wide
fos-OR/392r	50mm wide

Osteotomes, Chisels and Gouges

Albee Osteotome

190mm long

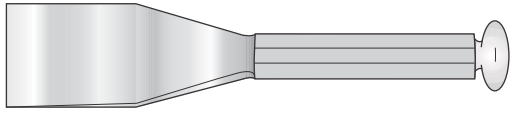

Code	Description
fos-OR/NO62a	Width 38mm
fos-OR/NO62b	Width 50mm

Small Gouges

150mm long



Code	Description
fos-OR/16-4	4mm wide
fos-OR/16-6	6mm wide
fos-OR/16-8	8mm wide

Moore Hollow Osteotome

Rectangular, for curved standard stems



Code	Description
fos-OR/N008	135mm long
fos-OR/N008a	255mm long

Box Chisel

Blue acetal "Suregrip" handle, 285mm long



Code
fos-OR/N008b

Small Osteotomes

150mm long



Code	Description
fos-OR/14-4	4mm wide
fos-OR/14-6	6mm wide
fos-OR/14-8	8mm wide

Alexander Gouge

Straight, 170mm long



Code	Description
fos-OR/290	Width 5mm
fos-OR/291	Width 7mm

Code	Description
fos-OR/292	Width 9mm
fos-OR/293	Width 11mm

Small Chisels

150mm long



Code	Description
fos-OR/18-4	4mm wide
fos-OR/18-4	6mm wide
fos-OR/18-4	8mm wide

Partsch Gouge

Straight



140mm long

Code	Description
fos-OR/283	Width 3mm
fos-OR/284	Width 4mm
fos-OR/285	Width 5mm
fos-OR/286	Width 6mm

170mm long

Code	Description
fos-OR/294	Width 3mm
fos-OR/287	Width 4mm
fos-OR/295	Width 5mm
fos-OR/288	Width 6mm
fos-OR/289	Width 7mm

Wire Cutting Pliers

Tungsten carbide edge, for cutting up to and including 6mm \varnothing

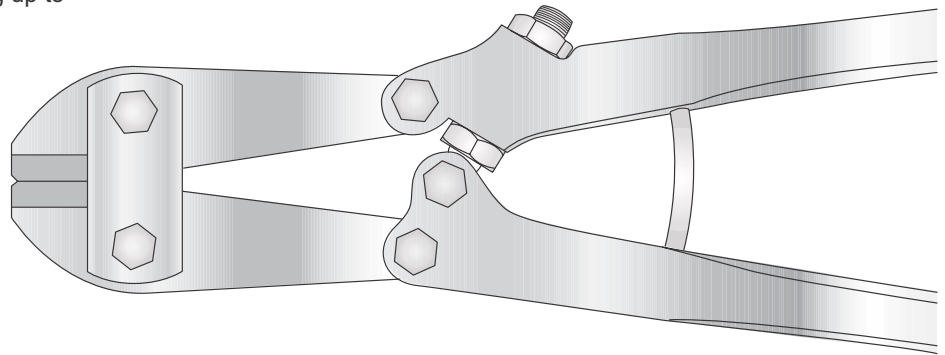

Code	Description
fos-OR/258	450mm long
fos-OR/259	560mm long

Wire Cutting Pliers

Tungsten carbide edge, for cutting Kirschner wires up to and including 5.5mm \varnothing

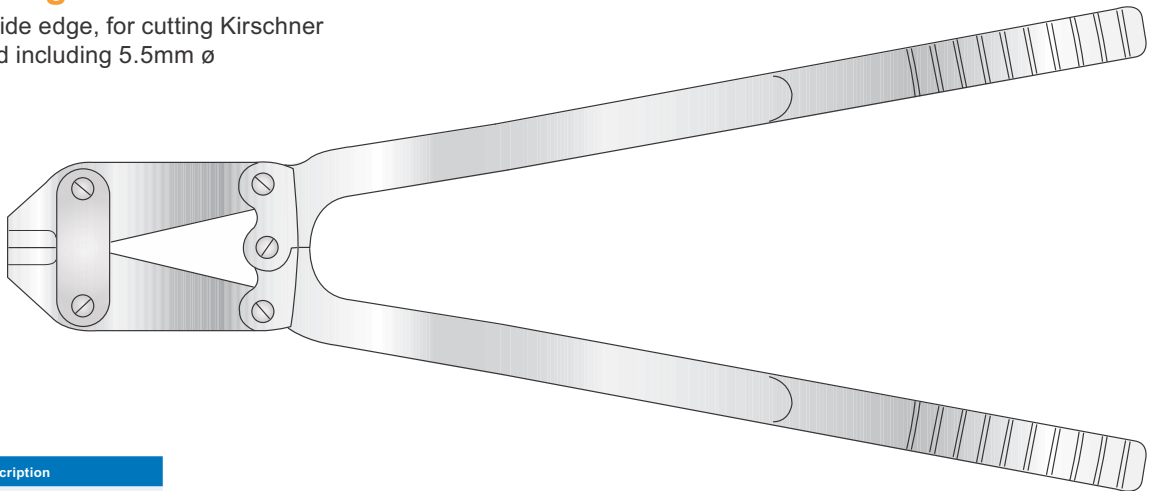

Code	Description
fos-OR/07a	480mm long

Wire Cutting Pliers

Tungsten carbide edge, for cutting Kirschner wires up to 4mm \varnothing

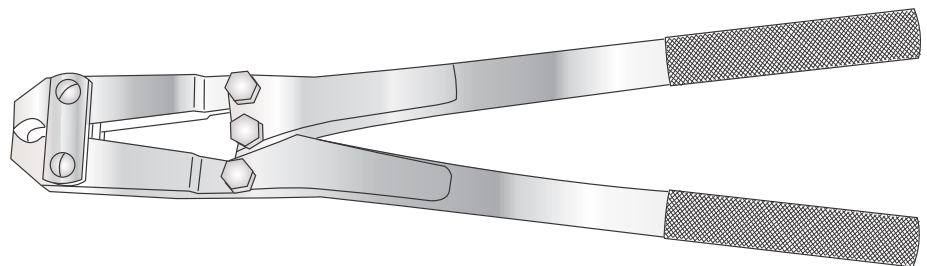

Code	Description
fos-OR/261	380mm long

Wire Cutters and Pliers

Top Cutter

Gold handles, tungsten carbide edge, for cutting Kirschner wire

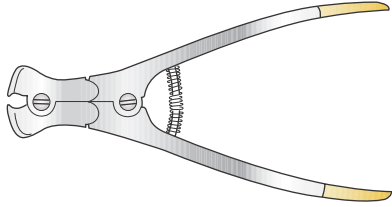

Code	Description
fos-OR/06	Up to 2.5mm, 215mm long
fos-OR/06a	Up to 1.5mm, 145mm long

Side Cutter

Gold handles, tungsten carbide edge, jaws have rounded edges, for cutting Kirschner wires

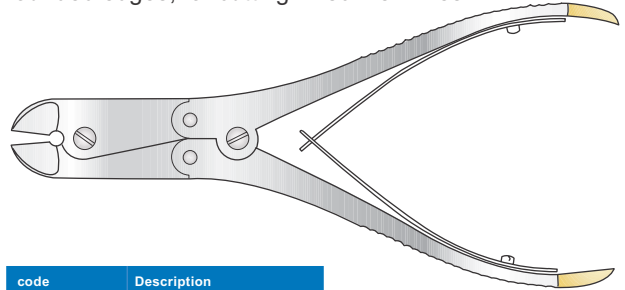

code	Description
fos-OR/331	Up to 2.5mm ø, 230mm long
fos-OR/332	Up to 2.2mm ø, 215mm long
fos-OR/333	Up to 1.5mm ø, 145mm long

Top and Side Cutter

Small, gold handles, tungsten carbide edge, for cutting Kirschner wires up to 1.5mm ø

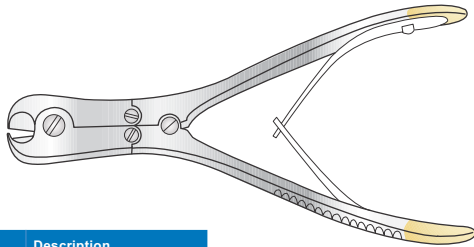

Code	Description
fos-OR/06b	175mm long

Wire Cutting Pliers

Gold handles, tungsten carbide edge, 120mm long

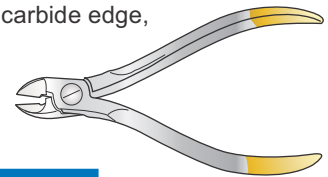

Code	Description
fos-OR/263	For wire up to 0.2mm ø
fos-OR/267	For wire up to 0.3mm ø
fos-OR/262	For wire up to 0.5mm ø
fos-OR/269	For wire up to 0.5mm ø 115mm long
fos-OR/268	For wire up to 0.7mm ø

Side Cutter

Compound action, angled tungsten carbide jaw, gold handles, for Kirschner wire up to 1.6mm ø

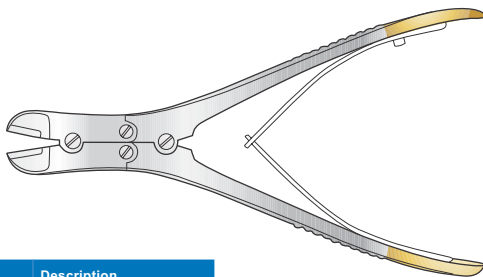

Code	Description
fos-OR/N060	180mm long

Orthopaedic Plier/Cutter

Stainless steel

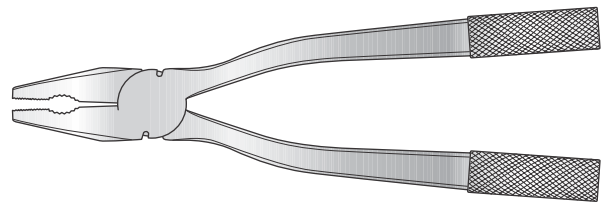

Code	Description
fos-OR/271b	180mm long
fos-OR/271c	220mm long

Side Cutter

Gold handles, tungsten carbide edge, for cutting Kirschner wires up to 1.5mm ø

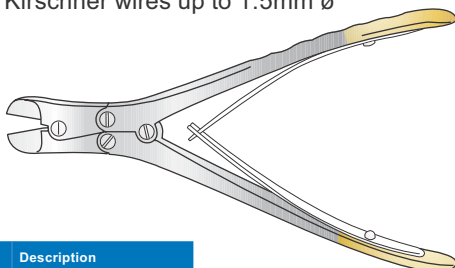

Code	Description
fos-OR/260	170mm long

Bone Plate Bender/Wire Cutter Pliers

For nipping and breaking of soft wire only
Not suitable for Kirschner wires

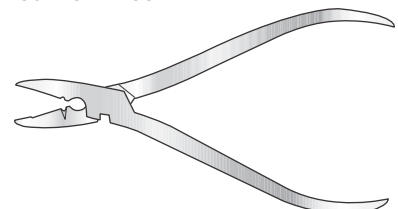

Code	Description
fos-OR/32a	150mm long

Pliers for Wire

175mm long

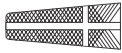
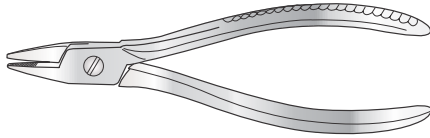

Code
fos-OR/273

Code
fos-OR/275

Orthopaedic Plier/Cutter

Stainless steel, tungsten carbide edge, for cutting Kirschner wire up to 1.6mm

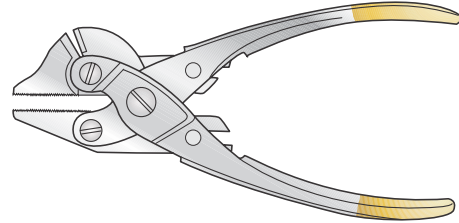

Pliers for Bone Burrs

190mm long

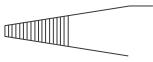
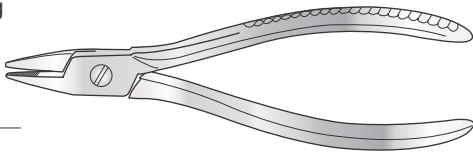

Code
fos-OR/274

Code	Description
fos-OR/271a	TC 180mm long
fos-OR/271b	Non TC for cutting soft wire only, max cut 1.6mm, 180mm long

Mole Grip Type Wrench

Stainless steel

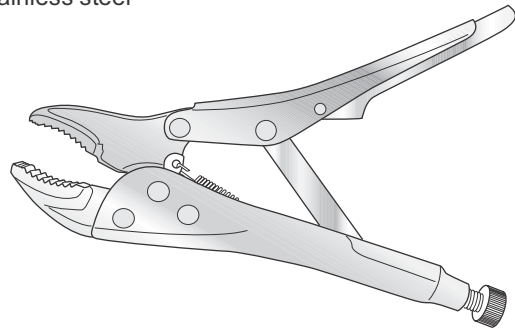

Orthopaedic Pliers

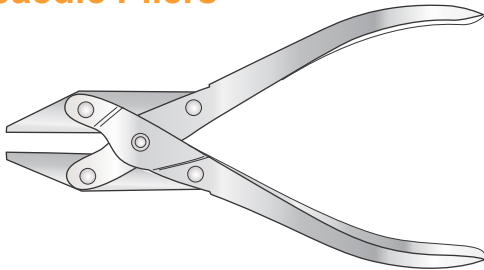

Code	Description
fos-OR/49b	185mm

Code	Description
fos-OR/N052	190mm long

Accessories

Wire Twister Biomet Type



Code	Description
fos-OR/49a	150mm long

Martin Cartilage Forceps

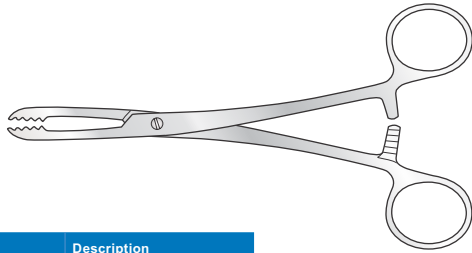

Code	Description
fos-OR/393	180mm long

Charnley Suture Forcep

Slotted, 1-2 teeth



Code	Description
fos-OR/N045	180mm long

Suture Wire Cutting Scissors

Angled to cut soft wire only, max cut 1.2mm

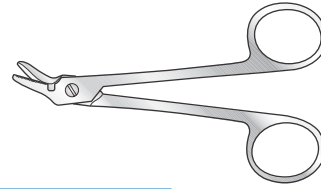

Code	Description
fos-OR/07b	120mm long

Suture Wire Cutting Scissors

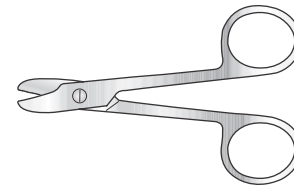

Code	Description
fos-OR/07c	110mm long

Mallet

With serrated head, 170mm long

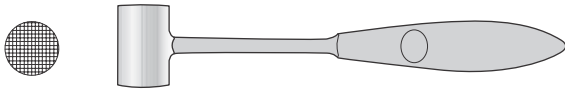

Code	Description
fos-OR/023	190 grams

Mallet

Blue acetal, 240mm long

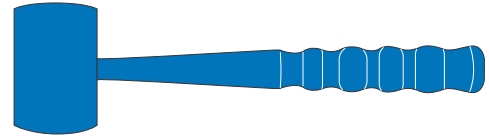

Code	Description
fos-OR/LE1001	340 grams, vertical end

Mallet

Blue acetal "Suregrip" handle, 275mm long

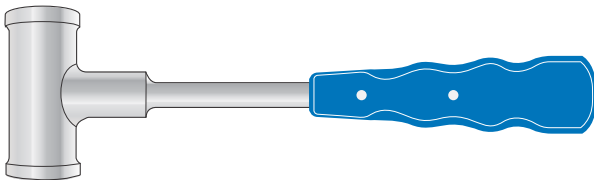

Code
fos-OR/270A-BH

Mallet

Blue acetal, 255mm long

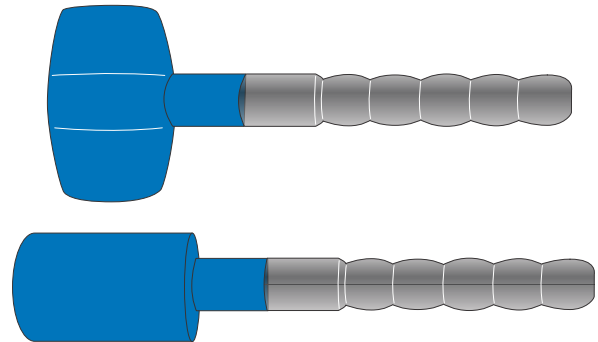

Code	Description
fos-OR/22a	520 grams, vertical end
fos-OR/22	650 grams, horizontal end

Mallet

Stainless steel, 270mm long

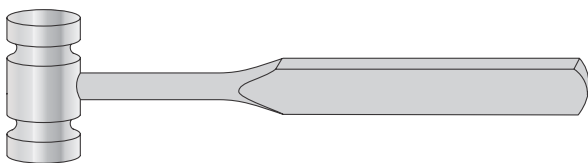

Code	Description
fos-OR/270	640 grams
fos-OR/271	1020 grams

Heath Mallet

Stainless steel, 135mm long

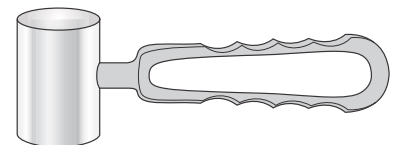

Code	Description	Code	Description
fos-OR/N044c	650 grams	fos-OR/N044	1150 grams
fos-OR/N044b	920 grams	fos-OR/N044a	1340 grams

Mallet

Stainless steel, with pistol grip*
240mm long

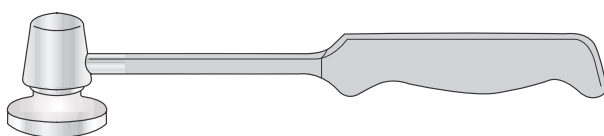

Code	Description
fos-OR/20	580 grams

*ALSO AVAILABLE WITH
BLUE ACETAL HANDLE

Royal Cornwall Mallet

Stainless steel, with extended handle and strong welded head, 190mm long

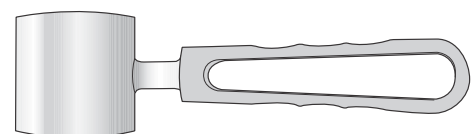

Code	Description
fos-OR/N044rc	1000 grams

Mallets

Orthopaedic Mallet

Surgical Holdings pattern, stainless steel, 170mm long

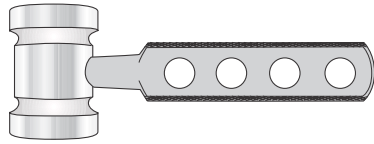

Code	Description
fos-OR/N055b	800 grams
fos-OR/N055	880 grams
fos-OR/N055a	1020 grams

Orthopaedic Mallet

Stainless steel, Surgical Holdings pattern, one flat and one domed end, 180mm long

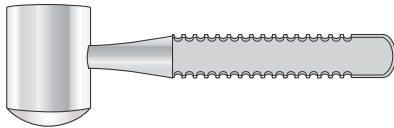

Code	Description
fos-OR/272a	960 grams
fos-OR/272c	750 grams

ToËe Hammer

Stainless steel, one plain and one serrated side, 190mm long

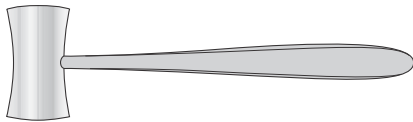

Code	Description
fos-OR/N047	280 grams

Ombredanne Mallet

Stainless steel, one flat and one domed end

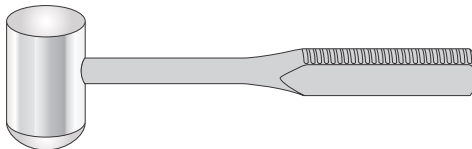

Code	Description
fos-OR/272	950 grams, 240mm long
fos-OR/272b	1110 grams, 270mm long

Collin Mallet

Stainless steel, 205mm long

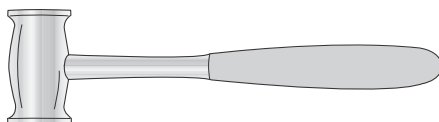

Code	Description
fos-OR/23	270 grams

Kelsey Fry Mallet

With renewable acetal ends, 190mm long

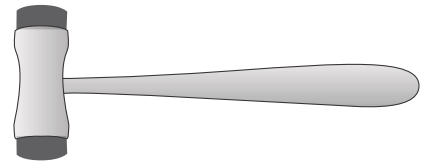

Code	Description
fos-OR/N047a	280 grams
fos-OR/N048	Replacement end - pair

Surgical Holdings Orthopaedic Mallet

Stainless steel with blue acetal "Suregrip" handle 270mm long

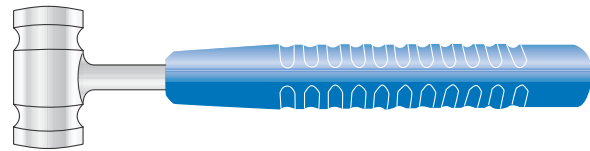

Code	Description	Code	Description
fos-OR/410	720 grams	fos-OR/412	900 grams
fos-OR/411	800 grams	fos-OR/413	970 grams

Surgical Holdings Orthopaedic Mallet

Stainless steel with blue acetal "Suregrip" handle 200mm long

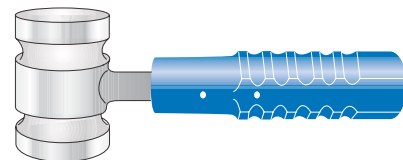

Code	Description	Code	Description
fos-OR/414BH	660 grams	fos-OR/416BH	1020 grams
fos-OR/415BH	790 grams	fos-OR/417BH	1400 grams

Surgical Holdings Mallet

Stainless steel with blue acetal "Suregrip" handle domed faced head, 200mm long

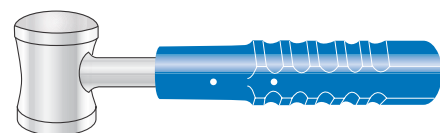

Code	Description
fos-OR/418BH	650 grams

Putti Raspatory



Code	Description
fos-OR/12	300mm long

OTHER SHAPES AND CONFIGURATIONS ON REQUEST

Bone File and Raspatory

Stainless steel



Code	Description
fos-OR/12a	215mm long

Austin Moore Type Raspatory

Including tommy bar,
295mm long

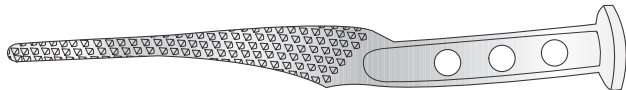

Code	Description
fos-OR/HP001	Standard
fos-OR/HP002	Narrow (not illustrated)

Thompson Type Raspatory

Including tommy bar

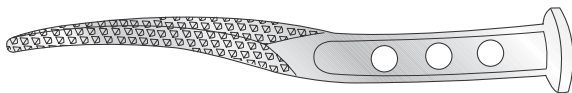

Many other types available
Supply a drawing of the prosthesis - we will make the rasp in any batch size you require. The teeth will be chipped up at 0.75mm per face over and above the size of the prosthesis stem, to allow for cementing.

Code	Description
fos-OR/HP003	270mm long

Miller Bone File

180mm long

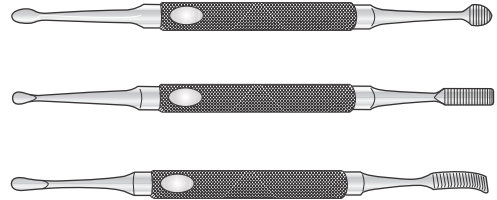

Code	Description
fos-OR/318	Short end
fos-OR/319	Slight curve
fos-OR/322	Full curve

McGoey Punch

Double ended, 220mm long

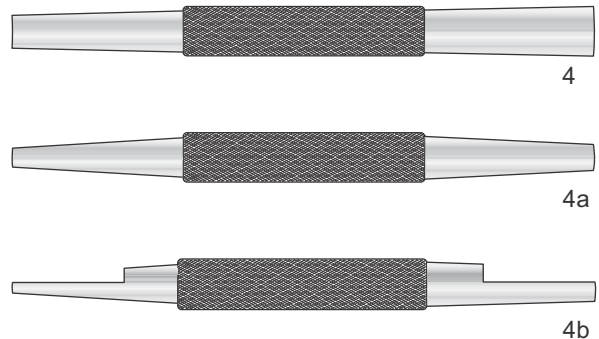

Code	Description
fos-OR/N04	13 x 19mm
fos-OR/N04a	6 x 10mm
fos-OR/N04b	13 x 6mm half round

Smillie Bone Punch



Head size 15 x 19.5mm

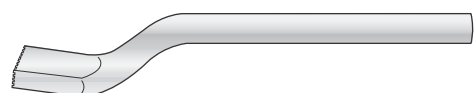

Head size 9.5 x 15.5mm

Code	Description
fos-OR/N018	Straight 140mm long
fos-OR/N019	Cranked 175mm long

Pushers, Impactors and Skids

Charnley Cup Pusher

With nylon head



Code	Description
fos-OR/N020	295mm long

Hardinge Cement Restrictor

With T handle



Code	Description
fos-OR/HR001	335mm long

Charnley Prosthesis Pusher

Stainless steel handle
with nylon insert



Code	Description
fos-OR/N021	180mm long

Moore Femoral Head Extractor

With T handle

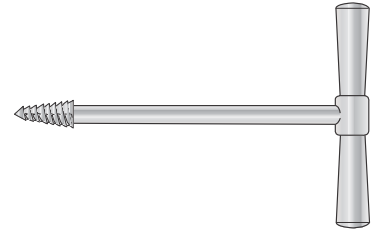

Code	Description
fos-OR/N005	150mm long
fos-OR/N006	205mm long

Judet Impactor

Stainless steel handle
with nylon head

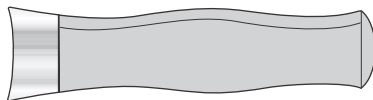

Code	Description
fos-OR/N009	140mm long

Murphy Skids

Double ended, 355mm long



Code	Description
fos-OR/N007	Uncoated
fos-DIA/111	Coated

Femoral Pusher

Head impactor, white Pomalux

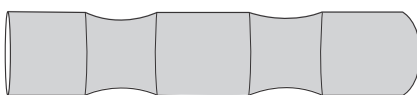

Code	Description
fos-OR/N053	31mm ø x 180mm long

Murphy Skids

Single ended, 330mm long



Code	Description
fos-OR/N007a	Coated

Adson Periosteal Elevator

Serrated grip, 165mm long

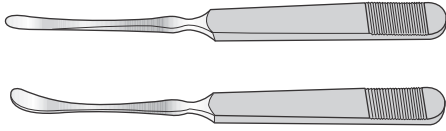

straight

Code	Description
fos-OR/N028	7mm wide

curved

Code	Description
fos-OR/N029	5mm wide
fos-OR/N030	7mm wide

Langenbeck Elevator

Straight

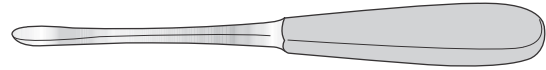

Code	Description
fos-OR/302	200mm long

Bristow Periosteal Elevator

Sharp edge



Code	Description
fos-OR/N010	240mm long

MacDonald Dissector Double Ended



Code	Description
fos-GI/285	191mm long

Doyen Periosteal Elevator

Satin finish handle

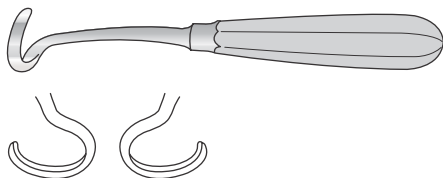

165mm long

Code	Description
fos-OR/N031	Right
fos-OR/N032	Left

180mm long

Code	Description
fos-OR/256	Right
fos-OR/255	Left

Pennybacker Elevator

Curved, sharp, 6mm wide

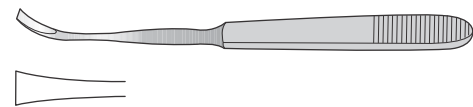

Code	Description
fos-OR/N025	170mm long

Key Periosteal Elevator

190mm long



Code	Description
fos-OR/N023	10mm wide
fos-OR/N024	13mm wide

Periosteal Elevator

Straight



Code	Description
fos-OR/19a	175mm long

Elevators

Periosteal Elevator

Straight, 12 x 20mm, with blue acetal "Suregrip" handle



Code	Description
fos-OR/SH-5695	195mm long

Periosteal Elevator

Curved, 5 x 25mm, with blue acetal "Suregrip" handle



Code	Description
fos-OR/SH-5696	185mm long

Tudor Edwards Periosteal Elevator

For first rib, satin finish handle, 175mm long

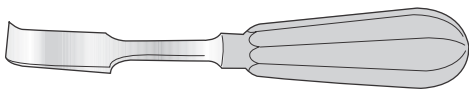

Code	Description
fos-OR/N026	12mm wide
fos-OR/N027	18mm wide

Hohmann Bone Elevator

Matt finish, 160mm long

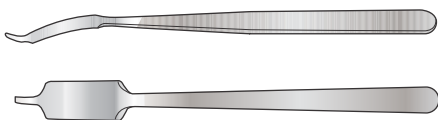

Code	Description
fos-OR/307a	6mm wide
fos-OR/307b	8mm wide
fos-OR/307d	10mm wide
fos-OR/307e	15mm wide

Hohmann-Muller Spike Elevator

With narrow spade



Code	Description
fos-OR/307f	220mm long, 10mm wide
fos-OR/307	230mm long, 12mm wide
fos-OR/308	240mm long, 18mm wide

Hohmann-Aldinger Bone Elevator

Curved

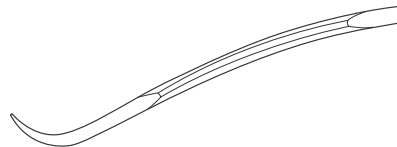

Code	Description
fos-OR/304	270mm long x 24mm wide

Hohmann Bone Elevator

Curved

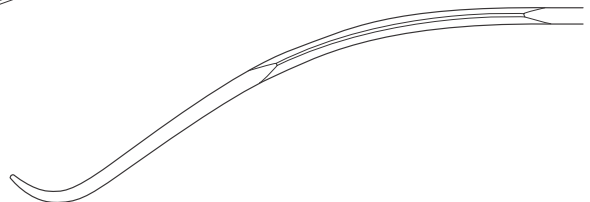
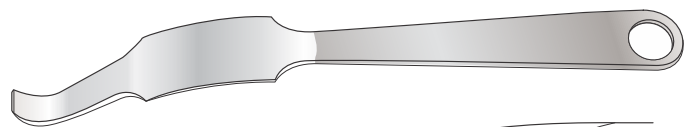

Code	Description
fos-OR/305	285mm long x 34mm wide

Hohmann Bone Lever

Curved, Leicester Royal Infirmary pattern

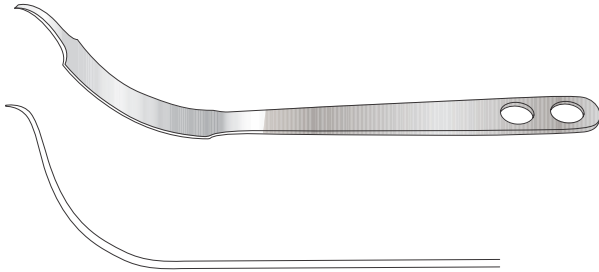

Code	Description
fos-OR/LGH-HOH	340mm long x 23mm wide

Wagner Bone Elevator

220mm long

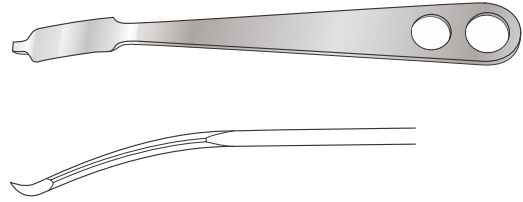

Code	Description
fos-OR/307h	17mm wide

Schumacher Bone Elevator

290mm long

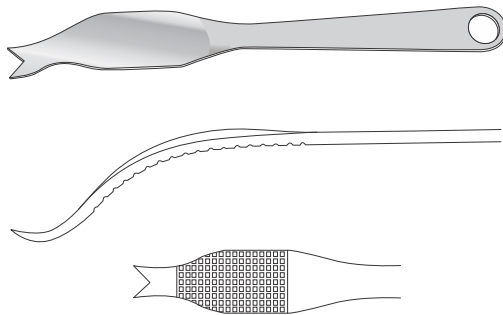

Code	Description
fos-OR/307k	35mm wide, 18mm at edge

Lange-Hohmann Bone Elevator

250mm long

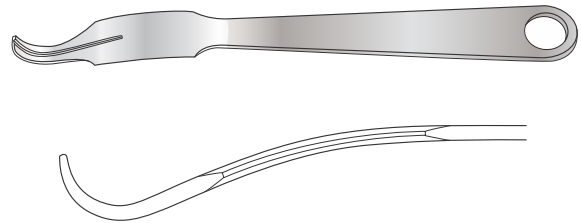

Code	Description
fos-OR/307i	24mm wide

Muller Soft Tissue Retractor

40mm wide

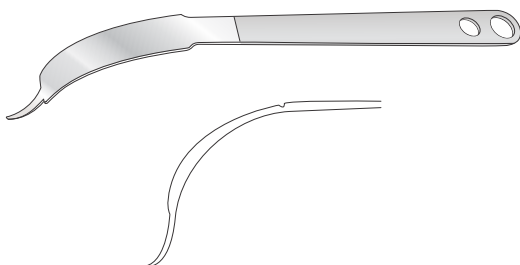

Code	Description
fos-OR/307aNOR	410mm long
fos-OR/307bNOR	300mm long

Schumacher Bone Elevator

345mm long

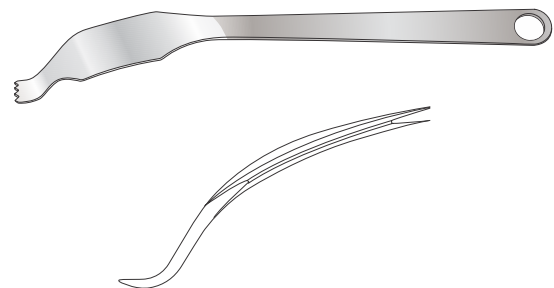

Code	Description
fos-OR/307j	37mm wide, 18mm at edge

Retractors and Bone Levers

Fakuda Type Retractor

230mm long

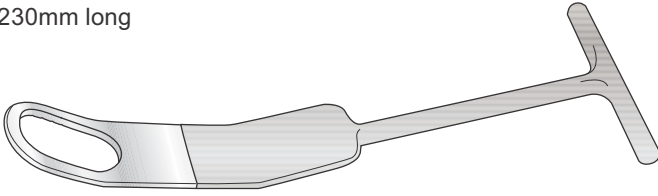

Code

fos-OR/SH5507

Hohmann Retractor

45° angle, 200mm long

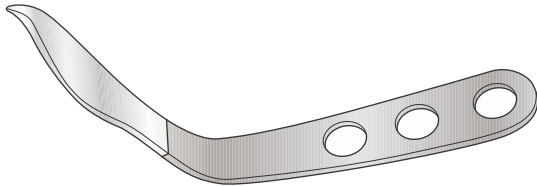

Code

fos-OR/SH5394

Hohmann Tapered Spike Retractor

225mm overall length

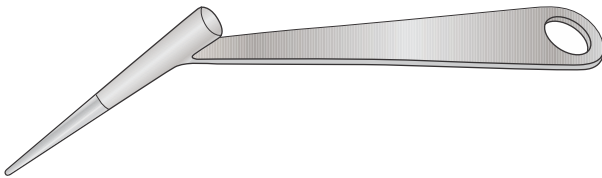

Code

fos-OR/308a

Posterior Bone Lever

230mm long

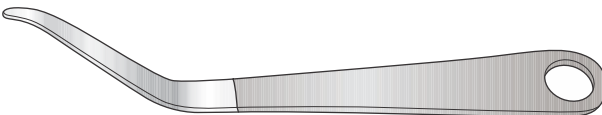

Code

fos-OR/308r

Trethowan Bone Lever

Bent, ring handle 222mm long, 280mm long

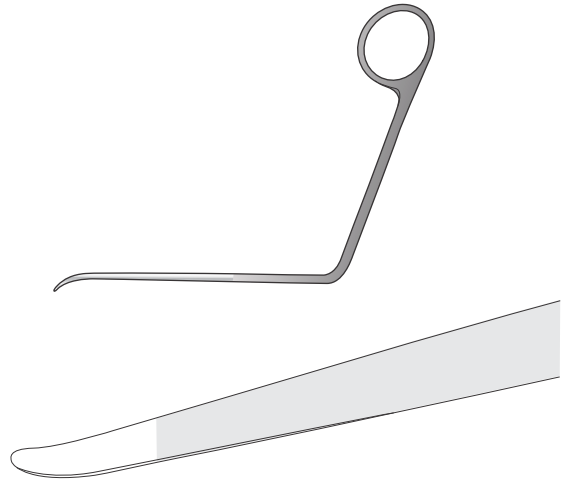

Code	Description
fos-OR/no17b	90° angle
fos-OR/no17c	70° angle (illustrated)
fos-OR/no17d	45° angle

Gigli Saw Handles

Per pair

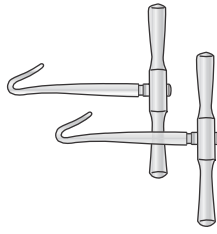

Code	Description
fos-OR/08	65mm long

Guys Tenotomy Knife



Code	Description
fos-OR/N046	140mm long

Charnley Saws

Code	Description
fos-OR/10c	500mm long
fos-OR/11c	700mm long

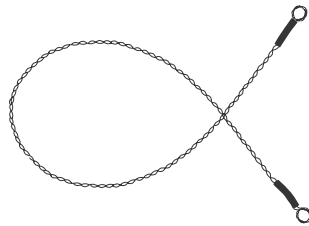

Smillie Menisectomy Knife

175mm long

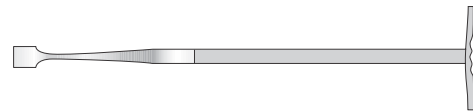

Gigli Saws

Code	Description
fos-OR/09	300mm long
fos-OR/10	500mm long
fos-OR/11	700mm long

Code	Description
fos-OR/048	Straight

Collin Rib Shears

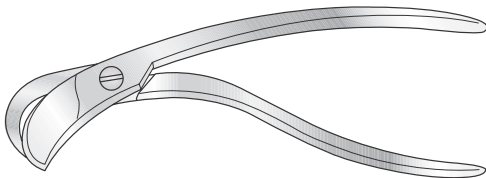

Code	Description
fos-OR/001	195mm long

Smillie Menisectomy Knife

Protruding beak at base, 175mm long

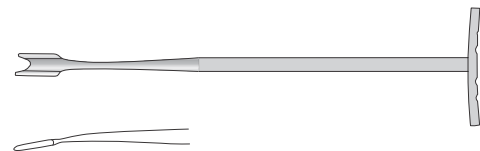

Code	Description
fos-OR/N0048a	Curved to right
fos-OR/N0048b	Curved to left

Screw and Plate Instruments

Allen Key Sets

Bright guard

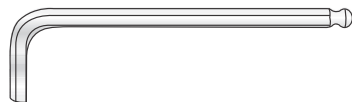

Code	Description
fos-OR/N051	1.5mm - 10mm

To order quote fos-OR/N051 then add size required e.g. fos-OR/N051-1.5

Size mm	Overall Length
1.5	63mm
2.0	77mm
2.5	87mm
3.0	93mm
4.0	104mm
5.0	120mm
6.0	141mm
7.0	147mm
8.0	158mm
10.0	180mm

Orthopaedic Ruler Stainless Steel



Code	Description
fos-OR/51a	Metric, 300mm

Pins

Denham Pin

Temporary implants, material conforms to BS 7252: Part 1: 1997. ISO 5832-1: 1997. Comp.D. CE marking available on request.



Code	Size
fos-DP/1-3SE	3.96mm dia x 203mm long trocar/3 side end
fos-DP/1SQ	3.96mm dia x 203mm long trocar/square end
fos-DP/2-3SE	3.96mm dia x 229mm long trocar/3 side end
fos-DP/2SQ	3.96mm dia x 229mm long trocar/square end

Code	Size
fos-DP/3-3SE	4.76mm dia x 203mm long trocar/3 side end
fos-DP/3SQ	4.76mm dia x 203mm long trocar/square end
fos-DP/4-3SE	4.76mm dia x 229mm long trocar/3 side end
fos-DP/4SQ	4.76mm dia x 229mm long trocar/square end

THREE SIDED END OR
SQUARE END IN STOCK
OTHER SIZES AVAILABLE

Steinmann Pins

Temporary implants, material conforms to BS 7252: Part 1: 1997. ISO 5832-1: 1997. Comp.D. CE marking available on request

Various specs available –
contact us for full information

Ø mm*	Ø mm*
1.58	3.96
2.00	4.36
2.38	4.76
2.78	6.00
3.17	6.35
3.57	8.00

LENGTHS 150, 180, 200, 250mm
*Other lengths and diameters available

When ordering, use prefix letters
with size following
e.g. Trocar with one screw end
Ø4.76mm = IPTS/476



IPTT = trocar/trocar ends



IPTS = trocar/trocar with one screw end



IPTSE = trocar/square end



IPTSE3 = trocar/with 3 sided end

Bohler Stirrup

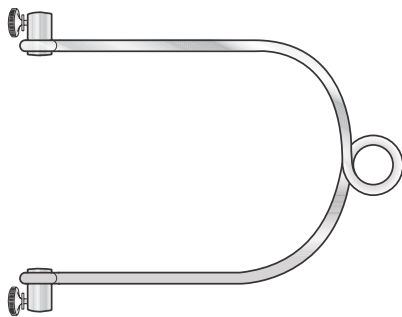

Code	Description
fos-OR/N001	Small 89 x 102mm
fos-OR/N002	Medium 114 x 165mm
fos-OR/N003	Large 152 x 241mm

Steinmann Pin Cap with Screw

Code	Description
fos-OR/54b-4	4mm ø
fos-OR/54c	Replacement screw

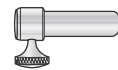

fos-OR 54b

Sterile Kirschner and Arthrodesis Wires

Sterile Kirschner and Arthrodesis Wires

Temporary implants, material conforms to BS 7252: Part 1: 1997. ISO 5832-1: 1997. Comp.D.

Sterile Trocar/ Sterile Trocar Arthrodesis Wires

Code	Size
KWHS325A-S	0.8mm x 70mm
KWHS037-S	0.9mm x 70mm
KWHS055-S	0.9mm x 75mm
KWHS091-S	0.9mm x 100mm
KWHS127-S	0.9mm x 125mm
KWHS145-S	0.9mm x 140mm
KWHS0009-S	0.9mm x 150mm
KWHS163-S	0.9mm x 180mm
KWHS038-S	1.0mm x 70mm
KWHS056-S	1.0mm x 75mm
KWHS092-S	1.0mm x 100mm
KWHS269-S	1.1mm x 90mm
KWHS272-S	1.1mm x 100mm
KWHS275-S	1.1mm x 115mm
KWHS278-S	1.1mm x 125mm
KWHS281-S	1.1mm x 140mm
KWHS0010C-S	1.1mm x 150mm

Code	Size
KWHS290-S	1.1mm x 200mm
KWHS0019B-S	1.25mm x 150mm
KWHS039-S	1.2mm x 70mm
KWHS093-S	1.2mm x 100mm
KWHS129-S	1.2mm x 125mm
KWHS147-S	1.2mm x 140mm
KWHS0010B-S	1.2mm x 150mm
KWHS165-S	1.2mm x 180mm
KWHS183-S	1.2mm x 200mm
KWHS040-S	1.4mm x 70mm
KWHS094-S	1.4mm x 100mm
KWHS112-S	1.4mm x 115mm
KWHS130-S	1.4mm x 125mm
KWHS148-S	1.4mm x 140mm
KWHS0011-S	1.4mm x 150mm
KWHS166-S	1.4mm x 180mm
KWHS184-S	1.4mm x 200mm

Code	Size
KWHS005-S	1.6mm x 50mm
KWHS041-S	1.6mm x 70mm
KWHS095-S	1.6mm x 100mm
KWHS113-S	1.6mm x 115mm
KWHS131-S	1.6mm x 125mm
KWHS0012-S	1.6mm x 150mm
KWHS167-S	1.6mm x 180mm
KWHS185-S	1.6mm x 200mm
KWHS283-S	1.8mm x 200mm
KWHS096-S	2.0mm x 100mm
KWHS114-S	2.0mm x 115mm
KWHS132-S	2.0mm x 125mm
KWHS0013-S	2.0mm x 150mm
KWHS168-S	2.0mm x 180mm
KWHS186-S	2.0mm x 200mm

Sterile Trocar/Sterile Kirschner Wires (Pack of 10 Sterile Singles)

Code	Size
KWHS325-S	0.8mm x 70mm
KWHS043-S	0.9mm x 70mm
KWHS061-S	0.9mm x 75mm
KWHS097-S	0.9mm x 100mm
KWHS133-S	0.9mm x 125mm
KWHS151-S	0.9mm x 140mm
KWHS0014A-S	0.9mm x 150mm
KWHS169-S	0.9mm x 180mm
KWHS044-S	1.0mm x 70mm
KWHS062-S	1.0mm x 75mm
KWHS098-S	1.0mm x 100mm
KWHS270-S	1.1mm x 90mm
KWHS273-S	1.1mm x 100mm
KWHS276B-S	1.1mm x 115mm
KWHS279-S	1.1mm x 125mm
KWHS282-S	1.1mm x 140mm
KWHS285-S	1.1mm x 150mm

Code	Size
KWHS291-S	1.1mm x 200mm
KWHS0015A-S	1.25mm x 150mm
KWHS045-S	1.2mm x 70mm
KWHS099-S	1.2mm x 100mm
KWHS135-S	1.2mm x 125mm
KWHS153-S	1.2mm x 140mm
KWHS0019-S	1.2mm x 150mm
KWHS171-S	1.2mm x 180mm
KWHS189-S	1.2mm x 200mm
KWHS046-S	1.4mm x 70mm
KWHS100-S	1.4mm x 100mm
KWHS118-S	1.4mm x 115mm
KWHS136-S	1.4mm x 125mm
KWHS154-S	1.4mm x 140mm
KWHS0021-S	1.4mm x 150mm
KWHS172-S	1.4mm x 180mm
KWHS190-S	1.4mm x 200mm

Code	Size
KWHS011-S	1.6mm x 50mm
KWHS047-S	1.6mm x 70mm
KWHS101-S	1.6mm x 100mm
KWHS119-S	1.6mm x 115mm
KWHS137-S	1.6mm x 125mm
KWHS0017-S	1.6mm x 150mm
KWHS173-S	1.6mm x 180mm
KWHS191-S	1.6mm x 200mm
KWHS475-S	1.8mm x 200mm
KWHS102-S	2.0mm x 100mm
KWHS120-S	2.0mm x 115mm
KWHS138-S	2.0mm x 125mm
KWHS0018-S	2.0mm x 150mm
KWHS174-S	2.0mm x 180mm
KWHS192-S	2.0mm x 200mm

OTHER SIZES, FULL AND PARTIALLY THREADED STYLES ARE ALSO AVAILABLE PLEASE CONTACT US WITH YOUR REQUIREMENTS.

Extremities Instruments and Sets

Fine Hand Set

Includes: small stille type mallet 17cm long and 2mm, 4mm, 6mm, 8mm, 10mm and 12mm osteotomes

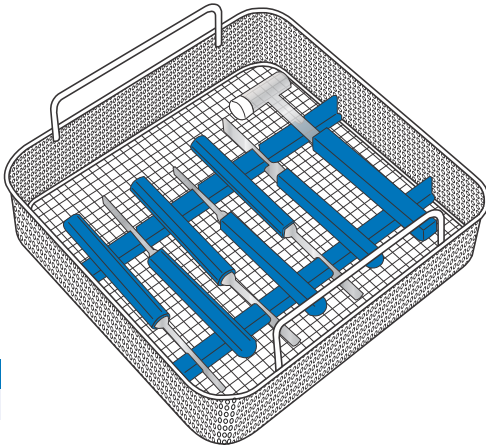

Code
SH-6969

Mini-Lexer Gouges

With blue acetal handle



Code	Description
fos-OR/587-04	4mm wide, 18cm long
fos-OR/587-06	6mm wide, 18cm long
fos-OR/587-08	8mm wide, 18cm long
fos-OR/587-10	10mm wide, 18cm long

Flexible Chisels and Blades

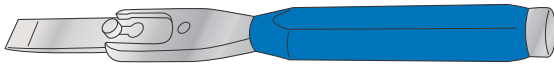

Code	Description
fos-OR/593	Allen key for flat chisel blades introducer handle 185mm long
fos-OR/594	Chisel blade 5mm for introducer handle
fos-OR/594A	Chisel blade 5mm curved for introducer handle
fos-OR/595	Chisel blade 10mm for introducer handle
fos-OR/595A	Chisel blade 10mm curved for introducer handle
fos-OR/596	Chisel blade 15mm for introducer handle
fos-OR/596A	Chisel blade 15mm curved for introducer handle
SH-6954	Introducer handle for flat chisel blades 185mm long

Mini-Lexer Osteotome and Gouge Set

Includes 4mm, 6mm, 8mm, 10mm gouges 18cm long and 2mm, 4mm, 6mm, 8mm and 10mm osteotomes 18cm long

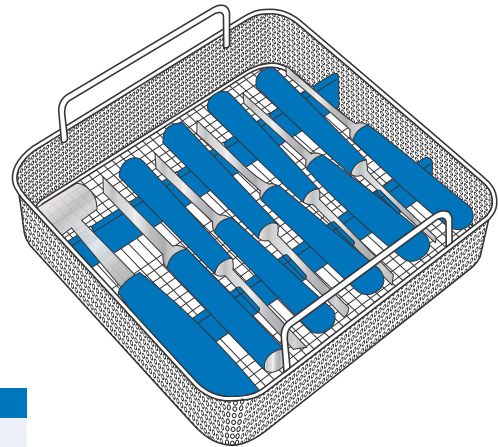

Code
fos-OR/587

Mini Fine Hand Osteotomes

With blue acetal handle



Code	Description
SH-6956	2mm wide, 165mm long
SH-6957	4mm wide, 165mm long
SH-6958	6mm wide, 165mm long
SH-6959	8mm wide, 165mm long
SH-6960	10mm wide, 165mm long
SH-6961	12mm wide, 165mm long

Mini-Lexer Osteotomes

With blue acetal handle



Code	Description
fos-OR/588-02	2mm wide, 18cm long
fos-OR/588-04	4mm wide, 18cm long
fos-OR/588-06	6mm wide, 18cm long
fos-OR/588-08	8mm wide, 18cm long
fos-OR/588-10	10mm wide, 18cm long

Removable Flexible Chisel and Blade Set

With blue acetal handle

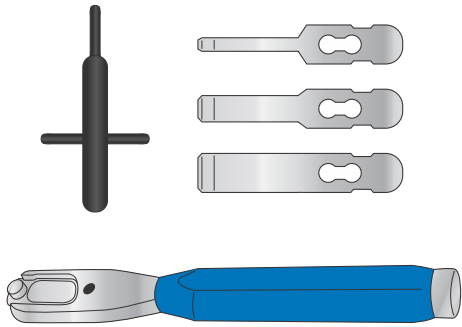

Code	Description
SH-7002	5mm, 10mm and 16mm straight
SH-7002A	5mm, 10mm and 16mm curved

Chirobloc Hand Immobiliser

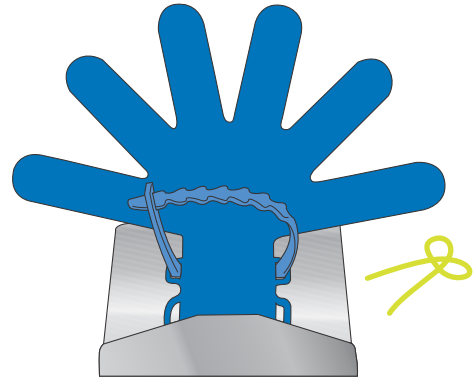

Code	Description
CB3	Chirobloc 3 with wrist strap and 5 ForgetMeNots
CBL	Chirobloc Ballast
CBM	Chirobloc Large
CBP	Chirobloc Small
FMN2B.B	Chirobloc ForgetMeNot Blue
FMN2B.Y	Chirobloc ForgetMeNot Yellow

Small Mallet

Small mallet 340 gram 210mm long with one flat and one round end fitted with blue acetal handle

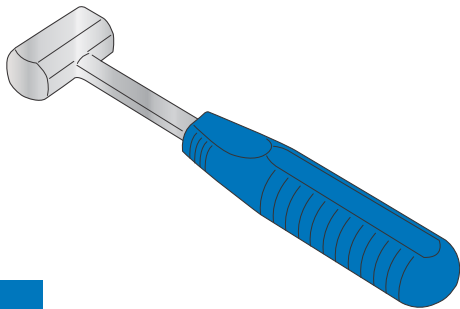

Code
SH-6955

Small Stille Type Mallet

Ultra fine mallet 180mm long with one nylon head fitted with a blue acetal handle 180 gram

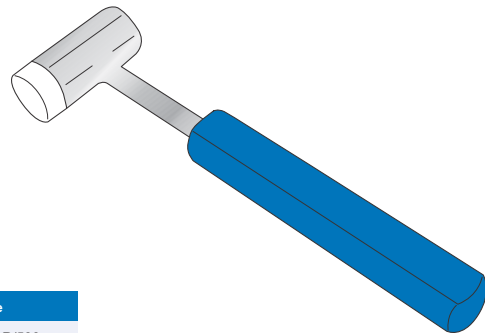

Code
fos-OR/580

Shoulder Instruments

Kolbel Soft Tissue Retractor

Single-pronged, angled, 190mm

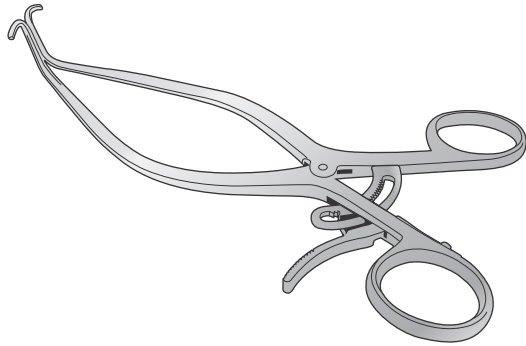

Code

SH004637943

Kolbel Soft Tissue Retractor

Single-pronged, straight, very fine tips, 190mm

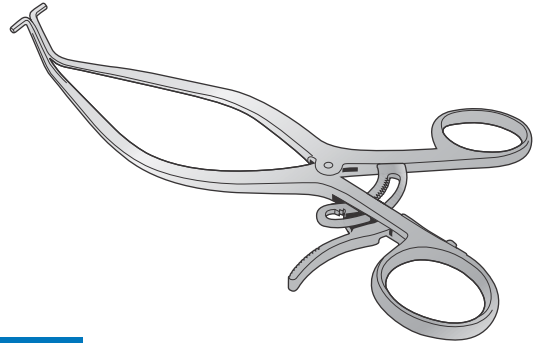

Code

SH004636943

Kolbel Soft Tissue Retractor

Double pronged, angled, 190mm

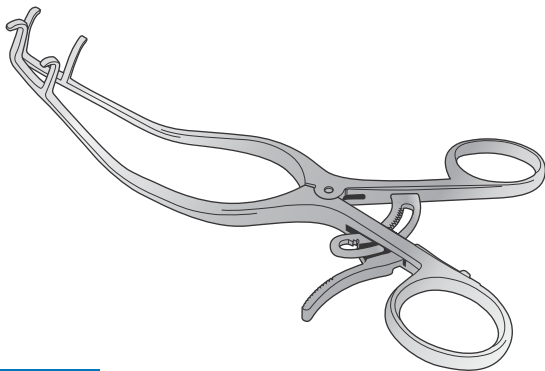

Code

SH004454965

Capsule Spreader

Single-pronged, fine, 90° curved, 165mm

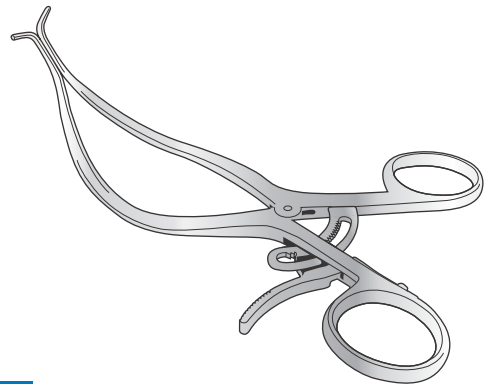

Code

SH004455954

Fukuda-Kujat Humeral Head Retractor

35mm, wide blade, 225mm

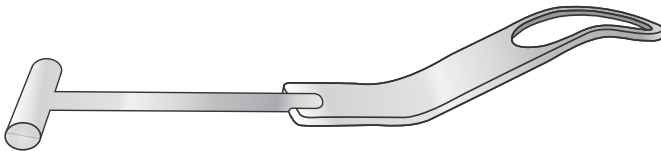

Code

SH0046351113

Kolbel Self Retaining Glenoid Retractor

With ball snap-fit, slightly curved, 200mm

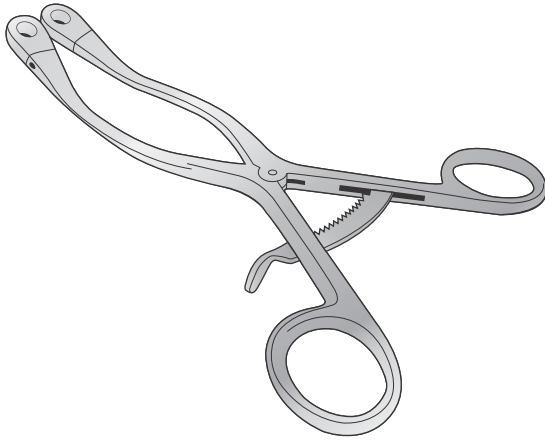

Code
SH004459965

Kolbel Glenoid Retractor

Double-pronged, angled tips, 300mm, 18mm straight



Code
SH004458416

Kolbel Glenoid Retractor

Double-pronged, angled tips, 300mm, 15mm strongly curved



Code
SH004457V318416

Pair of Kolbel Self Retaining Glenoid Retractor Blades

With ball fit

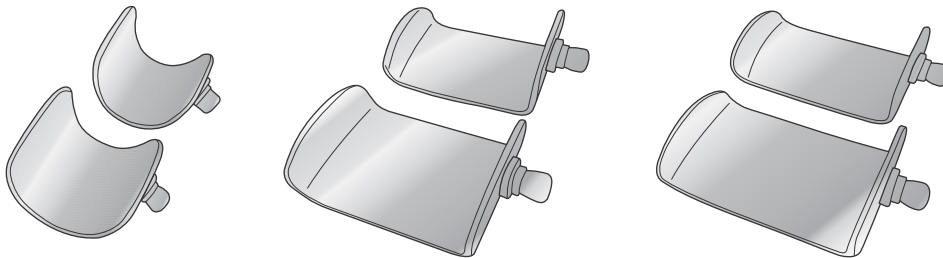

Code	Description
SH004460954	Pair of blades size 36 x 36mm
SH004461V316	Pair of blades size 53 x 36mm
SH004462V319	Pair of blades size 68 x 36mm



Plastic/Oral

Scissors	181
Needle Holders	182
Forceps	183
Raspatories and Elevators	184
Raspatories	185
Spring Forceps, Hooks and Picks	187
Retractors	188
Osteotomes, Chisels and Gouges	190
Miscellaneous	191

Kilner Scissors

Rounded blades, 115mm long

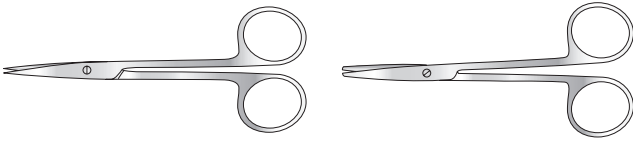

Code	Description
fos-PL/001a	Straight, sharp points
fos-PL/001b	Curved, blunt points

Aufricht Dissecting Scissors

Heavy pattern, triangular blades, 140mm long

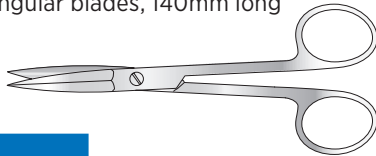

Code	Description
fos-PL/002a	Straight
fos-PL/002d	Curved

Aufricht Dissecting Scissors

Light pattern, 150mm long

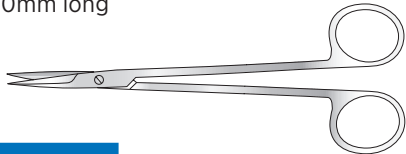

Code	Description
fos-PL/002b	Straight
fos-PL/002c	Curved

Scissors

Curved, sharp points

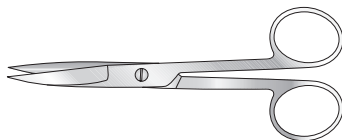

Code	Description
fos-PL/004	130mm long

Scissors

Angular, for cutting cartilage, wire cutting notch

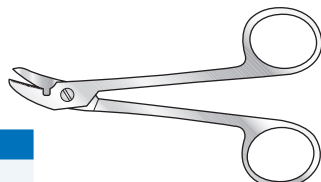

Code	Description
fos-PL/006	127mm long

McIndoe Scissors

Curved on flat, round tapering ends

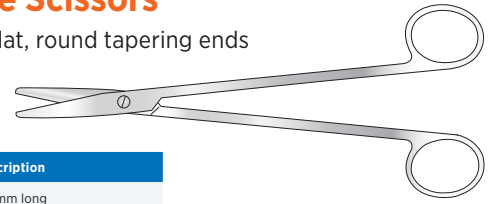

Code	Description
fos-PL/007	190mm long

Stevens Tenotomy Scissors

Supercut, 114mm long

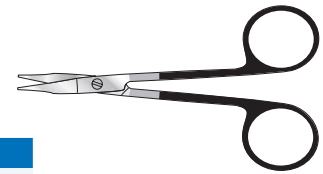

Code	Description
fos-B/424	Curved/blunt
fos-B/425	Curved/sharp
fos-B/426	Straight/blunt
fos-B/427	Straight/sharp

Cartilage Cutting Scissors

Fine points, serrated edges

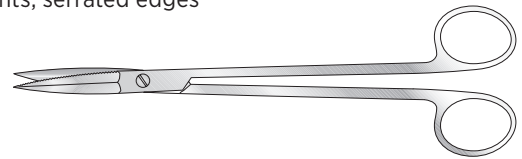

Code	Description
fos-PL/009	190mm long

Gorney Supercut Scissors

Rhytidectomy scissor, tungsten carbide, one micro serrated and one razor sharp edge

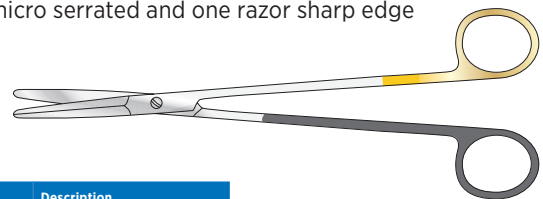

Code	Description
fos-PL/085a	125mm long
fos-PL/085	200mm long, straight
fos-PL/085b	200mm long, curved

Fickling (Cathcart) Scissors

Angled

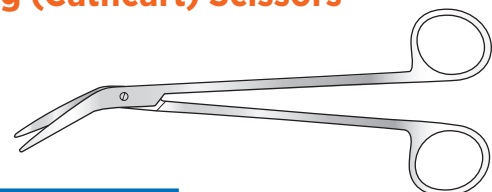

Code	Description
fos-PL/049	180mm long

Needle Holders

Foster Scissor/Needle Holder

Fenestrated jaw, 125mm long

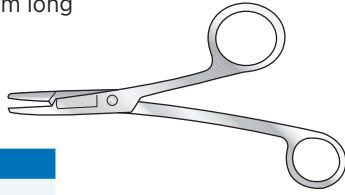

Code	Description
fos-PL/010a	Left

Lawrence Needle Holder

Fine jaw, 150mm long

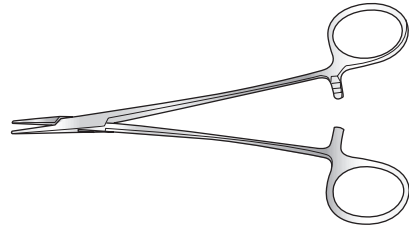

Code	Description
fos-PL/012a	
fos-PL/012b	Tungsten carbide, with two gold bows

Derf Needle Holder

Tungsten carbide insert, with two gold bows

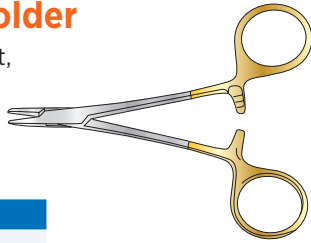

Code	Description
fos-PL/013	115mm long
fos-PL/013L	125mm long

Reverdin Suture Needle

With automatic eye, 203mm long

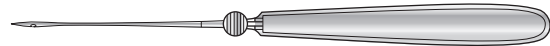

Code	Description
fos-PL/013a	Fully curved
fos-PL/013b	Curved
fos-PL/013c	Slightly curved
fos-PL/013d	Straight

Masing Needle Holder

Tungsten carbide insert, one angled bow

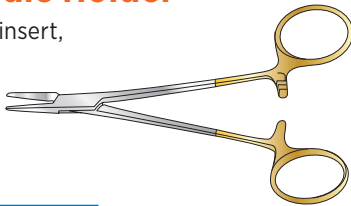

Code	Description
fos-Ø09R	130mm long

Castroviejo Needle Holder

Code	Description
fos-Ø021	140mm long, with catch
fos-Ø020	140mm long, without catch

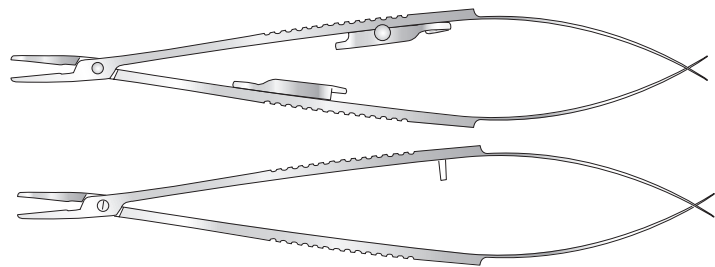

Diamond dust jaws

Code	Description
fos-TØ060	180mm long, without catch
fos-TØ061	200mm long, without catch
fos-TØ062	215mm long, without catch



ALSO AVAILABLE WITH CATCH - ADD SUFFIX CTH TO CODE

Tungsten carbide jaws

Code	Description
fos-TØ058a	180mm long
fos-TØ058	200mm long
fos-TØ059	215mm long

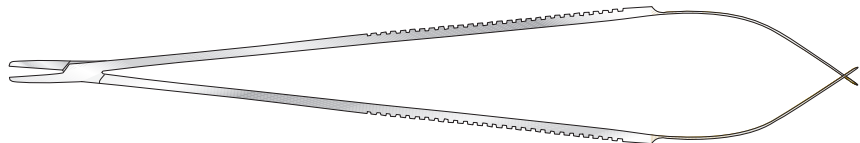

ALSO AVAILABLE WITH CATCH - ADD SUFFIX CTH TO CODE

Mustarde Suture Holding Forceps

Convex and concave jaw

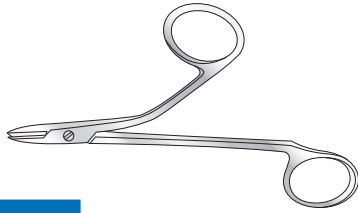

Code	Description
fos-PL/011	133mm long

Walsham Septum Straightening Forceps

220mm long

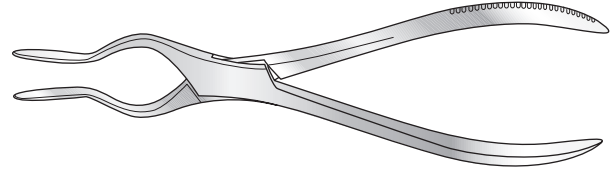

Code	Description
fos-PL/030a	Straight
fos-PL/030b	Right
fos-PL/030c	Left

Fickling Artery Forceps

190mm long

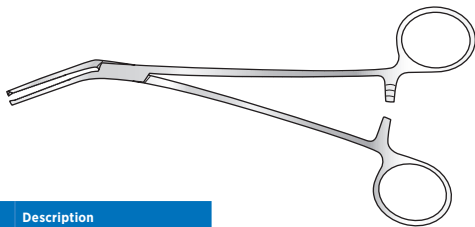

Code	Description
fos-PL/044a	Serrated
fos-PL/044b	1-2 teeth

Bone Cutting Forceps

Straight, compound action

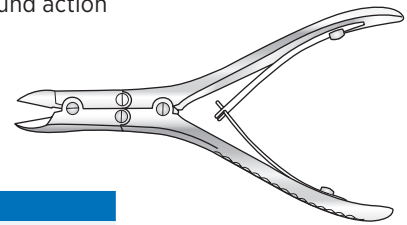

Code	Description
fos-PL/033	146mm long

Asch Septum Forceps

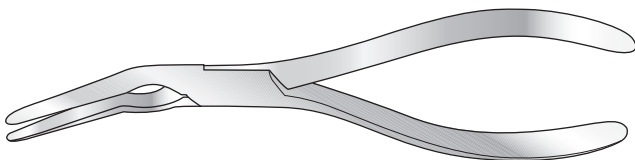

Code	Description
fos-PL/031	235mm long

Ward Bone Cutting Forceps

Slightly angled on flat

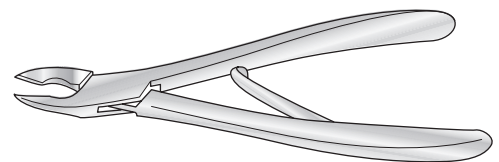

Code	Description
fos-PL/038	178mm long

Jansen-Middleton Septum Forceps

Compound action, 178mm long

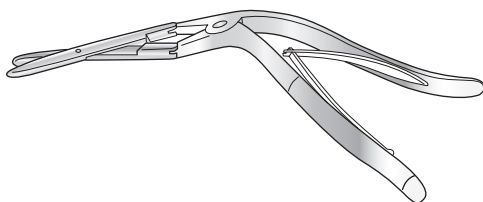

Code	Description
fos-PL/032	5mm bite

Raspatories and Elevators

Cleft Palette Raspatory



Code	Description
fos-PL/091	Curved downwards
fos-PL/092	Curved upwards

Cleft Palette Raspatory

Curved upwards

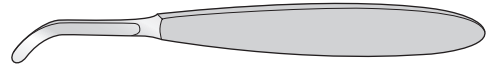

Code	Description
fos-PL/091	Left
fos-PL/092	Right

McIndoe Raspatory

For cleft palette, spoon end, 170mm long



Code	Description
fos-/PL088	Small
fos-/PL089	Medium
fos-/PL090	Large

Farabeuf Elevator

Light, 160mm long

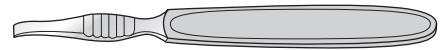

Code	Description
fos-PL/024	12mm curved
fos-PL/024a	8mm curved

Howarth Elevator



Code	Description
fos-PL/025	220mm long

Syme Periosteal Elevator

Double ended



Code	Description
fos-PL/046	170mm long

Cryer Elevator

150mm long

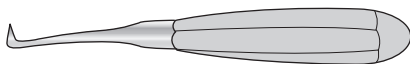

Code	Description
fos-PL/069	Right
fos-PL/069a	Left

Coupland Elevator

Curved, 150mm long

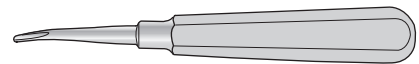

Code	Description
fos-PL/068	3mm wide
fos-PL/068a	3.5mm wide
fos-PL/068b	4mm wide

Aufricht Raspatory

9mm wide, 220mm long

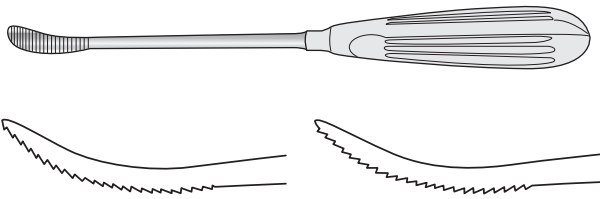

Code	Description
fos-PL/095	Up stroke
fos-PL/095a	Down stroke



Durogrip Raspatory

7mm wide, 205mm long



12/14 teeth

Code	Description
fos-PL/096	12/14 teeth
fos-PL/096a	16/20 teeth
fos-PL/096b	24/30 teeth
fos-PL/096c	36/44 teeth
fos-PL/096d	52/62 teeth

Gallagher Raspatory

190mm long

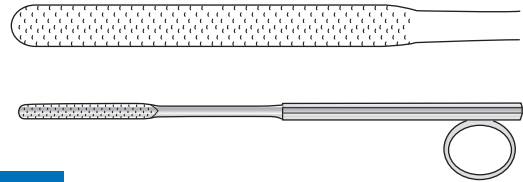

Code
fos-PL/098

Joseph Raspatory

Chequered, 165mm long

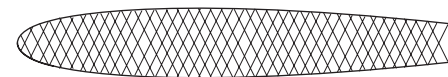
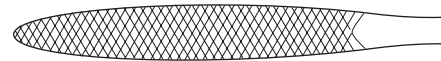

Code	Description
fos-PL/099	Fine, 7.5mm
fos-PL/099a	Coarse, 9mm

Lewis Raspatory

8mm wide, 175mm long

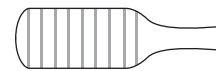

Code	Description
fos-PL/100	Fine teeth
fos-PL/100a	Coarse teeth

Fomon Raspatory

6.5 and 7.5mm wide, 215mm long

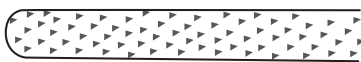

Code	Description
fos-PL/097	Chequered
fos-PL/097a	Knotched

Raspatories

Maltz Raspatory

180mm long

Code	Description
fos-PL/101	Straight, 9mm
fos-PL/101b	Straight, 5mm
fos-PL/101c	Curved, 5mm

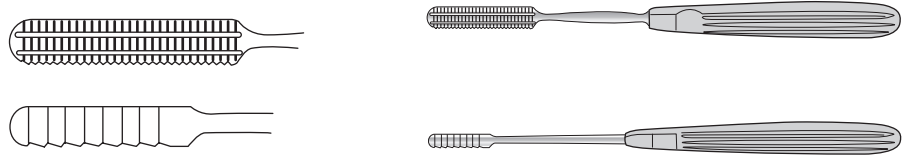

Miller Raspatory

180mm long



Code	Description
fos-PL/102	4.3 & 6mm
fos-PL/102a	5 & 6mm
fos-PL/102b	5 & 8mm

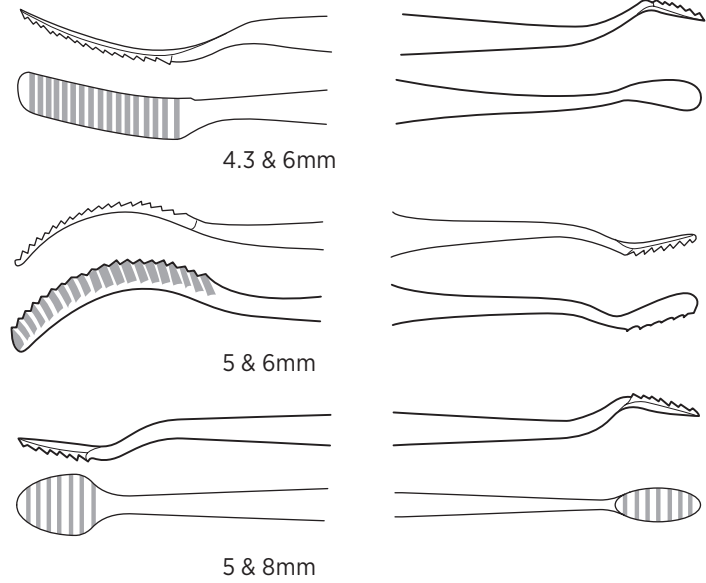

Spring Forceps, Hooks and Picks

Gillies Dissecting Forceps



Code	Description
fos-PL/052	1 x 2 teeth, 152mm long

McIndoe Dissecting Forceps

152mm long



Code	Description
fos-PL/053a	1-2 teeth
fos-PL/053b	Serrated

Waugh Dissecting Forceps

Fine, serrated



Code	Description
fos-£261	152mm long
fos-£262	178mm long
fos-£263	203mm long

College Pattern Stopping and Dressing Forceps

152mm long



Code	Description
fos-PL/048	Serrated

Mustarde Dissecting and Suture Holding Forceps

Combined double hooked jaws



Code	Description
fos-PL/050	156mm long



Childe Approximating Forceps

With magazine for Michel clips

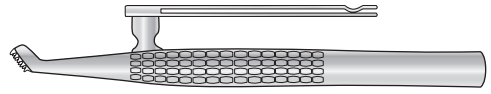

Code	Description
fos-PL/073	180mm long

Mitchell Trimmer

165mm long



Code	Description
fos-£/013	

Dental Pick



Code	Description
fos-PL/067	160mm long

Gillies Skin Hook

190mm long



Code	Description
fos-PL/065a	Standard
fos-PL/065b	Half Size

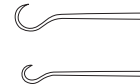

Joseph Double Skin Hook

165mm long



Code	Description
fos-PL/056a	

Kleinert Kutz Skin Hooks



Code	Description
fos-PL/109	16cm large
fos-PL/108	16cm medium
fos-PL/107	16cm small

Retractors

Alms Skin Retractor

Self retaining

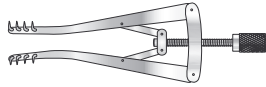

Code	Description
fos-PL/060	70mm long
fos-PL/060a	100mm long

Kilner Retractor

Double ended, cat's paw



Code	Description
fos-PL/056	152mm long

Kilner Alae Retractor

85mm long



Code	Description
fos-PL/063a	10mm
fos-PL/063b	13mm

Austin Kay Retractor

85mm long

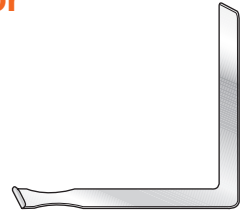

Code	Description
fos-PL/074	16mm wide

Bowdler Henry Retractor

170mm long

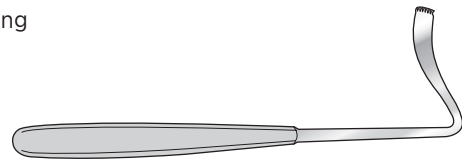

Code	Description
fos-PL/076	12mm wide

Tongue Retractor

190mm long

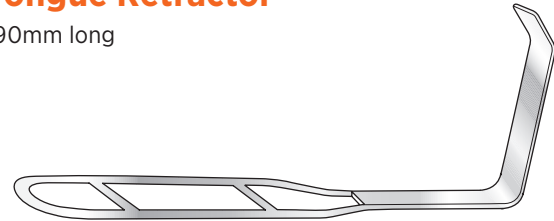

Code	Description
fos-PL/071	12mm wide

Cheek Retractor

140mm long

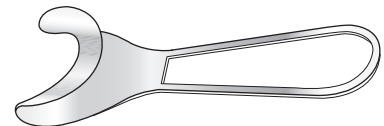

Code	Description
fos-PL/078	40mm wide

Ragnell Davis Retractor

140mm long



Code
fos-PL/074a

Flap Retractor

180mm long

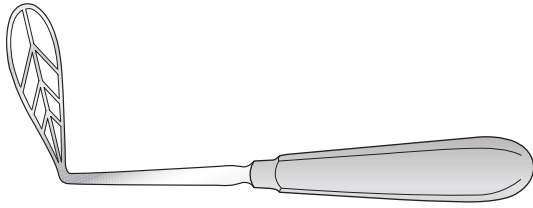

Code	Description
fos-PL/079	32mm wide

Kilner Cheek Retractor

Double ended, 167mm long



Code	Description
fos-PL/058a	Small, 19mm and 25mm wide
fos-PL/058b	Large, 29mm and 35mm wide

Kilner Nasal Retractor

152mm long



Code	Description
fos-PL/061a	7mm wide

Laster Cheek Retractor

110mm long

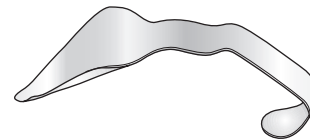

Code	Description
fos-PL/081	35mm wide

Hajek Retractor

Upper lip, 165mm long

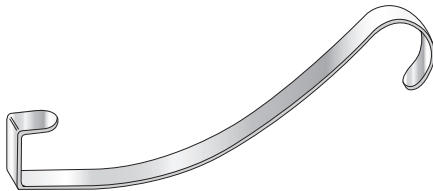

Code	Description
fos-PL/059	20mm wide

Freece Oral Retractor

150mm long

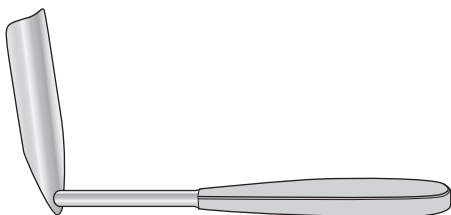

Code	Description
fos-PL/080	33mm wide

Osteotomes, Chisels and Gouges

Ward (East Grinstead) Osteotome

Square handle, 178mm long



Code	Description
fos-PL/040aeg	3mm wide
fos-PL/040beg	5mm wide

Silver Nasal Chisel

182mm long



Code	Description
fos-PL/029a	Straight
fos-PL/029b	Curved to right
fos-PL/029c	Curved to left

Gillies (French Pattern) Osteotome

140mm long



Code	Description
fos-PL/026	3mm wide
fos-PL/026a	5mm wide
fos-PL/026b	7mm wide
fos-PL/026c	9mm wide
fos-PL/026g	11mm wide
fos-PL/026d	16mm wide

Pterigoideus (Maxilla) Chisel



Code	Description
fos-PL/087	255mm long

Jenkins Chisel

140mm long



Code	Description
fos-PL/027a	2mm wide
fos-PL/027b	4mm wide
fos-PL/027c	6mm wide
fos-PL/027d	8mm wide
fos-PL/027e	10mm wide

Tilley Septum Gouge

V shaped, straight



Code	Description
fos-PL/043	127mm long

McIndoe Nasal Chisel

152mm long

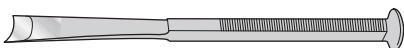

Code	Description
fos-PL/028a	5mm wide
fos-PL/028b	7mm wide
fos-PL/028c	9mm wide
fos-PL/028d	11mm wide

Fickling Dental Mallet

191mm long

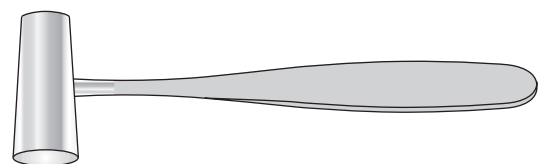

Code	Description
fos-PL/044	25mm ø, tapering head

Silver Skin Graft Knife

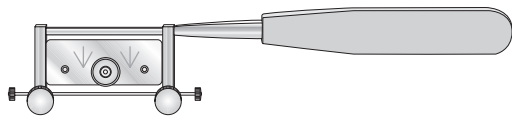

Code	Description
fos-PL/015a	190mm long

Eckhoff Mapping Pen



Code	Description
fos-PL/019	145mm long
fos-PL/019a	Nibs packs of 10

Sommerland Surgical Marking Pen

Adjustable four-pointed tip



Code	Description
fos-PL/020	152mm long

Gillies Suction Tube

Control valve, 180mm long

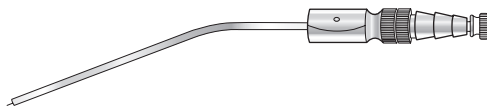

Code	Description
fos-PL/075a	2.5mm
fos-PL/075b	3mm
fos-PL/075c	3.5mm

Watson Skin Graft Knife

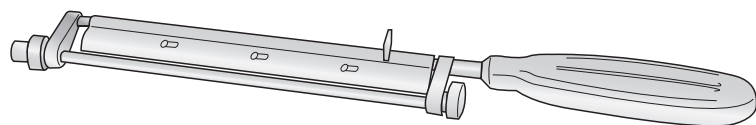

Code	Description
fos-PL/017	Right-handed
fos-PL/017L	Left-handed

Doyen Mouth Gag

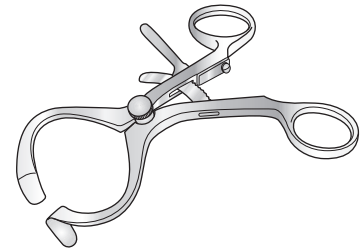

Code	Description
fos-B/88d	Adult
fos-B/88e	Child

Fergusson Ackland Mouth Gag

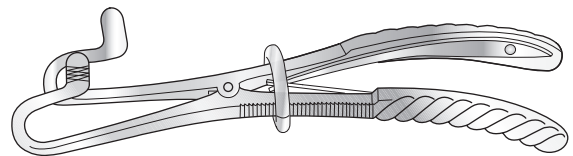

Code	Description
fos-B/209	Adult, 210mm
fos-B/209a	Child, 155mm

Dental Cartridge Syringe

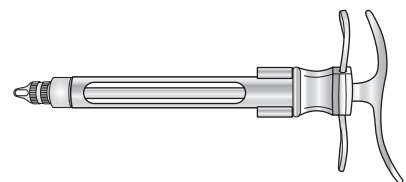

Code	Description
fos-PL/072	115mm long

Miscellaneous

Freeman Areola Nipple Sizer

1.5mm

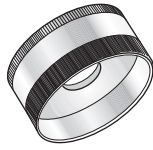

Code	Description
fos-PL/R25	25mm ø
fos-PL/R40	40mm ø
fos-PL/R45	45mm ø
fos-PL/R50	50mm ø
fos-PL/R55	55mm ø

Kelsey Fry Bone Awl

148mm long

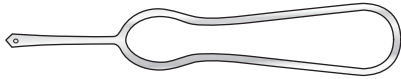

Code	Description
fos-PL/039a	Straight
fos-PL/039b	Curved

Joseph Nasal Saw

Blade 35mm long

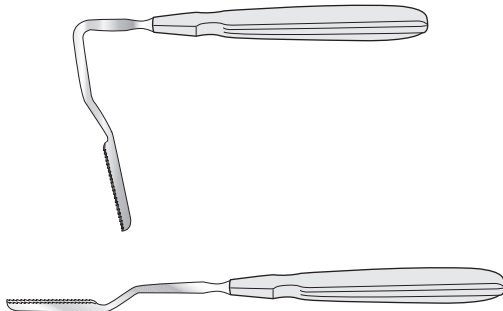

Horizontal shaft

Code	Description
fos-PL/034a	Cranked right
fos-PL/034b	Cranked left

Vertical shaft

Code	Description
fos-PL/034c	Cranked right
fos-PL/034d	Cranked left

Unna Comedo Expressor Double Ended Curette

2mm / 1mm holes

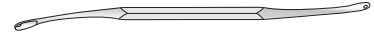

Code	Description
fos-PL/035	135mm long

Lang Steel Scoop

Double ended



Code	Description
fos-PL/064	7mm x 4mm, 140mm long

McHardy Curette

136mm long



Code	Description
fos-PL/036	1mm, 1.5mm, and 2mm ø

MacEwen Curette

Combined with seeker, 165mm long



Code	Description
fos-PL/045a	Oval
fos-PL/045b	Round

Post Mortem/ Autopsy

Scalpels and Knives	194
Scissors	196
Bone Cutting Forceps	198
Rib Shears	199
Dissecting Forceps	200
Needle Holder	200
Forceps	201
Clamps	201
Raspatory	201
Saws	202
Gouges	203
Chisels	203
Mallets	204
Probes	204
Retractor	204
Needles	204
Scalpel Blade Remover	204

Scalpels and Knives

Baron Scalpel Handle

130mm long



Code	Description
fos-PM/003	No 3
fos-PM/004	No 4

Scalpel Handle

127mm long

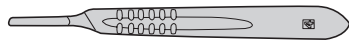

Code	Description
fos-PM/007	No 3
fos-PM/008	No 4
fos-PM/008a	No 4 L
fos-PM/001a	No 7

Solid Forged Scalpel

Stainless steel
140mm long



Code	Description
fos-PM/91	Blade length 25mm

Solid Forged Scalpel

Stainless steel
160mm long



Code	Description
fos-PM/92	Blade length 40mm

Solid Forged Scalpel

Stainless steel
165mm long



Code	Description
fos-PM/93	Blade length 50mm

Solid Forged Scalpel

Stainless steel
178mm long



Code	Description
fos-PM/94	Blade length 70mm

Catlin Knife

Solid forged stainless steel



Code	Description
fos-PM/011	Blade length 152mm

Cartilage Knife

Solid forged stainless steel



Code	Description
fos-PM/012	Blade length 133mm
fos-PM/013	Blade length 101mm

Resection Knife

Solid forged stainless steel

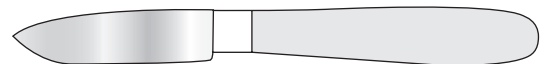

Code	Description
fos-PM/017	Blade length 76mm

Pelvic Organ Knife

Stainless steel, curved, double edged

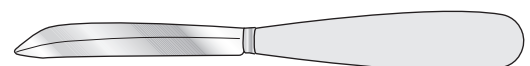

Code
fos-PM/020

Slicing Knife

For brain or organ, solid forged stainless steel, 22mm blade



Code	Description
fos-PM/009NH	Blade length 254mm
fos-PM/010NH	Blade length 152mm

Brain Knife

Solid forged stainless steel handle, 25mm blade



Code	Description
fos-PM/014	Blade length 254mm
fos-PM/016	Blade length 314mm
fos-PM/018	Blade length 254mm, 30mm blade

Organ Knife

Solid forged stainless steel, old style, 25mm blade

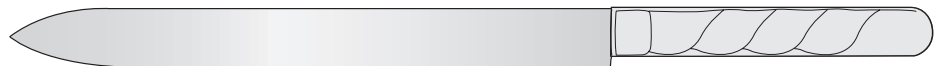

Code	Description
fos-PM/014NH	Blade length 254mm
fos-PM/016NH	Blade length 314mm

Organ Knife and Saw

Solid forged stainless steel, 22mm blade



Code	Description
fos-PM/017NH	Blade length 255mm

Organ Knife



Code	Description
fos-PM/100NH	Blade length 150mm, 22mm blade

Bistoury Knife

Probe end, curved, 70mm blade



Code	Description
fos-PM/023	176mm long

Rib Knife

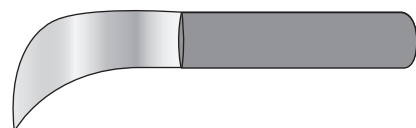

Code
fos-PM/025

Scissors

Scissors

Straight



Blunt/blunt

Code	Description
fos- B 33	130mm long
fos- B 36	146mm long
fos- B 39	165mm long

Sharp/blunt

Code	Description
fos- B 34	130mm long
fos- B 37	146mm long
fos- B 40	165mm long

Sharp/sharp

Code	Description
fos-PM/034	130mm long
fos-PM/035	146mm long
fos-PM/036	165mm long

Dissecting Scissors

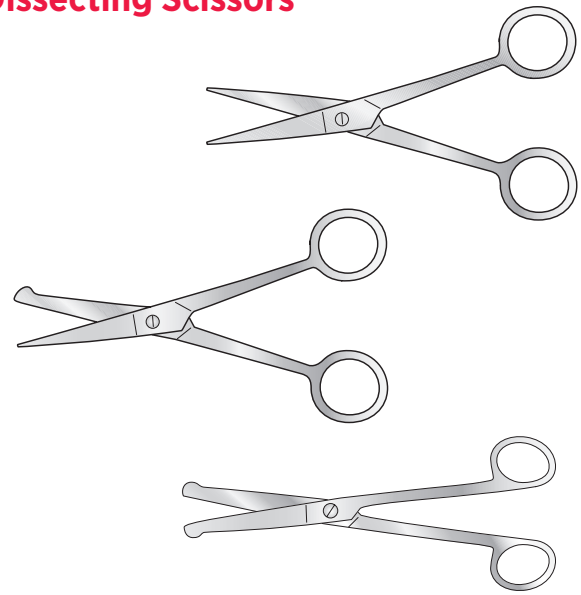

Sharp/sharp

Code	Description
fos-PM/046	127mm long

Sharp/probe

Code	Description
fos-PM/048	100mm long
fos-PM/047	127mm long
fos-PM/052	203mm long
fos-PM/052a	180mm long

Probe/probe

Code	Description
fos-PM/050	127mm long
fos-PM/053	203mm long

Scissors - Mayo

Straight, round point

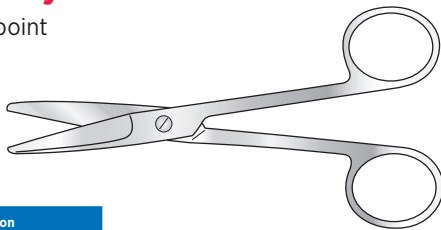

Code	Description
fos- B 409	140mm long
fos- B 409a	160mm long
fos- B 411	215mm long

Dressing Scissors

Fine end, tungsten carbide, supercut, 200mm long

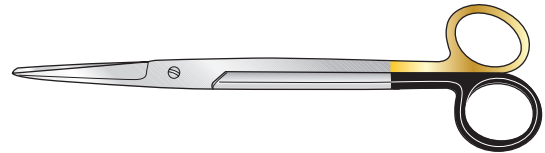

Code	Description
fos-PM/147	Blunt/sharp
fos-PM/149	Blunt/blunt

Scissors - Mayo

Fine point

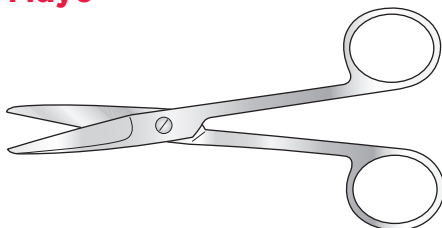

Code	Description
fos-PM/039	Straight 139mm long
fos-PM/043	Curved 139mm long
fos-PM/044	Curved 190mm long
fos-PM/045	Curved 215mm long

Artery Scissors

Small, for all arteries, tungsten carbide, supercut, 100mm long

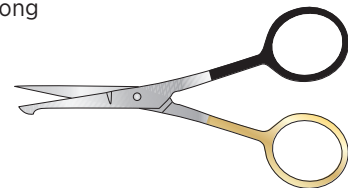

Code	Description
fos-PM/160	Sharp/probe

Dissection Scissors

Tungsten carbide, supercut, 175mm long

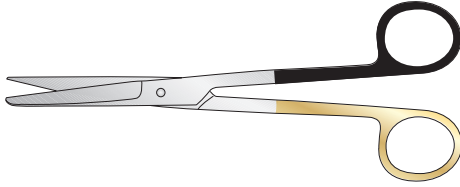

Code	Description
fos-PM/150	Blunt/blunt

Barnards Bowel Scissors

Guarded point, straight

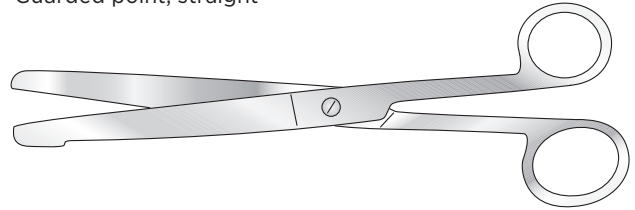

Code	Description
fos-PM/056	279mm long

Mayo Dissection Scissors

Tungsten carbide, supercut, for soft tissue, 175mm long

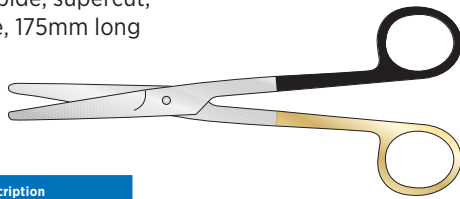

Code	Description
fos-PM/151	Sharp/blunt

Iris scissors

102mm long

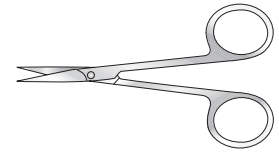

Code	Description
fos-D/032	Straight
fos-D/033	Curved

Bowel Scissors

Tungsten carbide, supercut, for dissection, straight, 180mm long

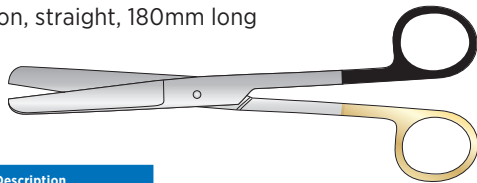

Code	Description
fos-PM/146	Blunt/blunt

Strabismus Scissors

114mm long

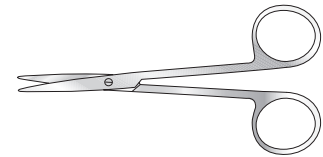

Code	Description
fos-D/29	Straight
fos-D/30	Curved

Scissors

Heavy

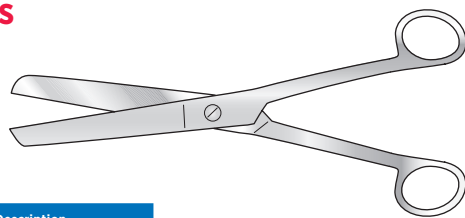

Code	Description
fos-PM/054	152mm long
fos-PM/055	177mm long

Metzenbaum Scissors

185mm long

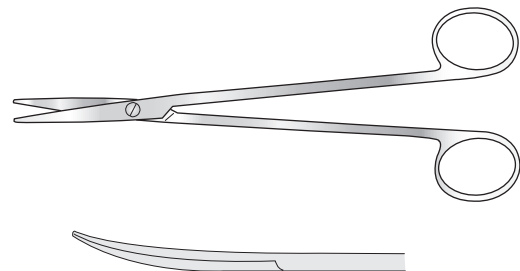

Code	Description
fos- B 405	Straight
fos- B 407	Curved

Bowel Scissors

Guarded point, straight

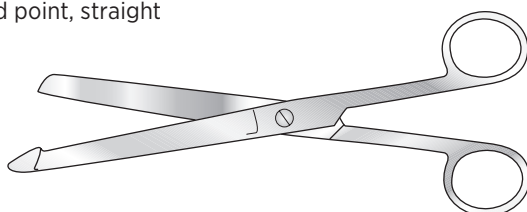

Code	Description
fos-PM/057	196mm long

Bone Cutting Forceps

Liston Bone Cutting Forceps

Straight

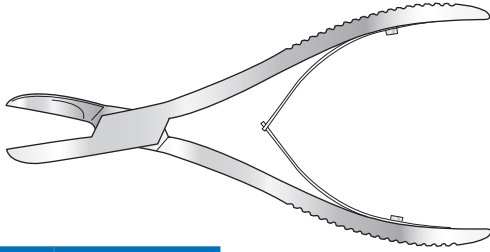

Code	Description
fos-B/032	200mm long
fos-B/027	220mm long
fos-PM/066	254mm long

Ferguson “Lion” Bone Holding Forceps

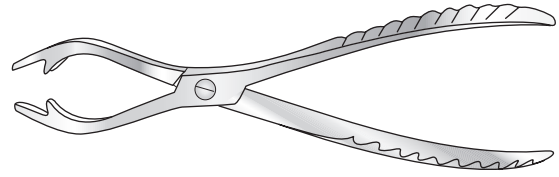

Code	Description
fos-PM/069	203mm long

Horsley Bone Cutter

Compound action
266mm long

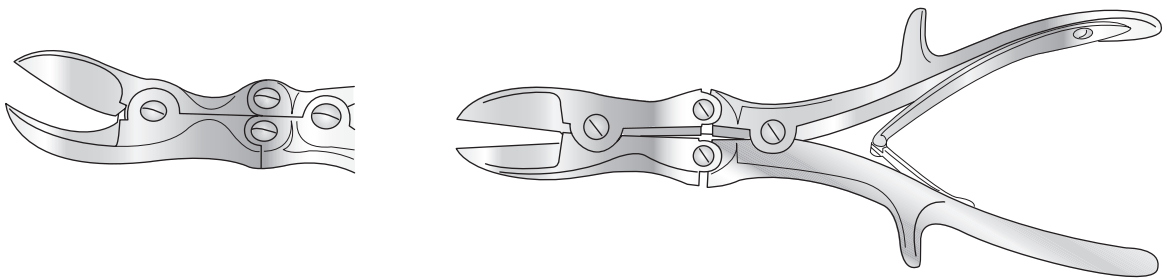

Code	Description
fos-PM/074	Straight
fos-PM/075	Angled

Liston Bone Cutting Forceps

Angled

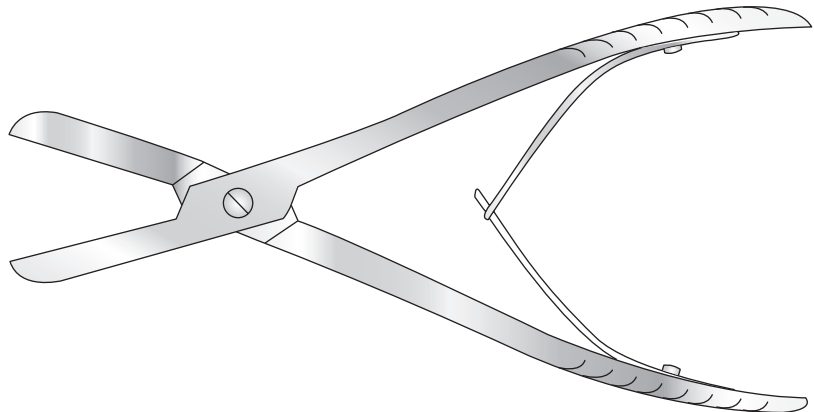

Code	Description
fos-PM/067	254mm long
fos-PM/068	304mm long

Rib Shears

London Hospital pattern

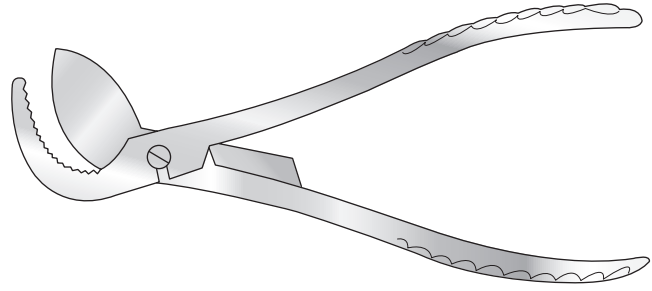

Code	Description
fos-PM/070	241mm long

Pollock Rib Shears

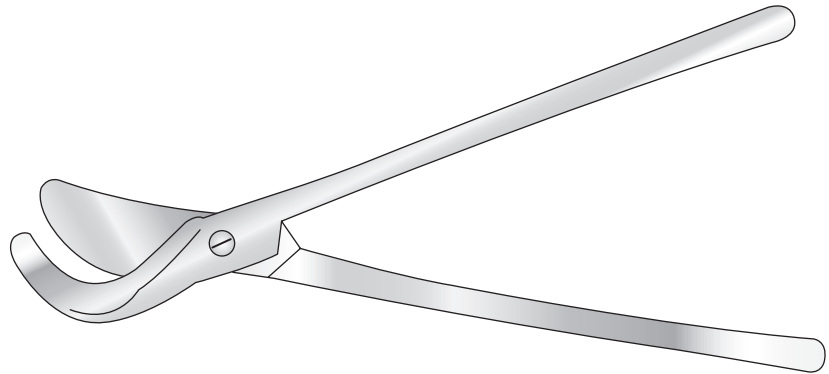

Code	Description
fos-PM/071	311mm long

Rib Shears

Surgical Holdings pattern

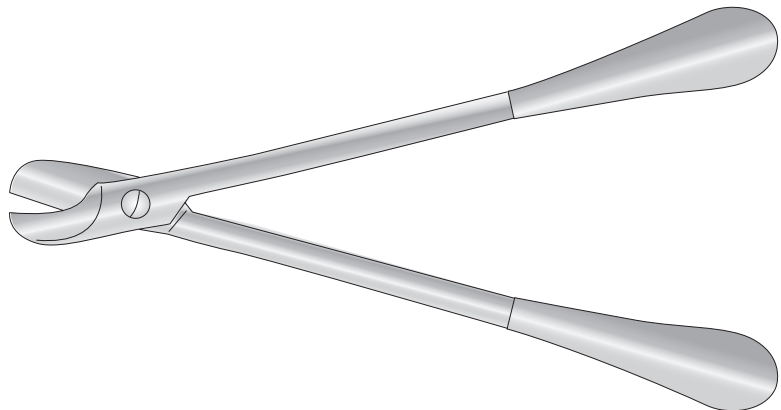

Code	Description
fos-PM/073a	387mm long

Eslander Rib Shears

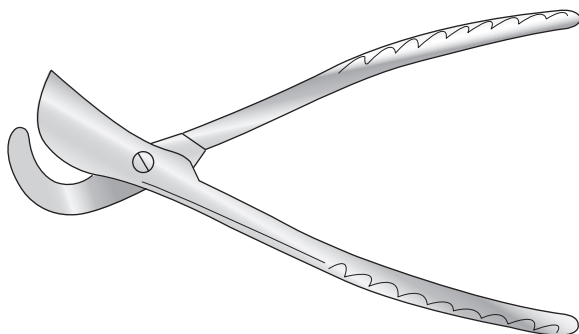

Code	Description
fos-PM/072	215mm long

Infant Skull Shears

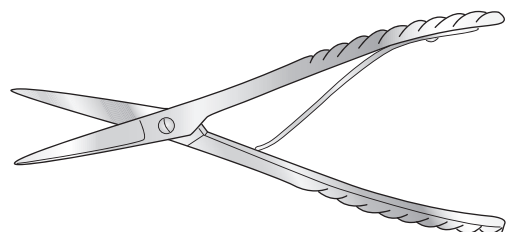

Code	Description
fos-PM/073	184mm long

Dissecting Forceps and Needle Holder

Dissecting Forceps

Serrated, turn over end

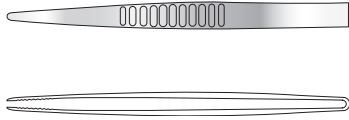

Code	Description
fos-£244	178mm long

Block End Dissecting Forceps

Straight, serrated

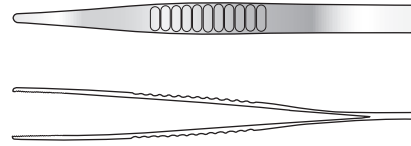

Code	Description
fos-£256	152mm long
fos-£256a	203mm long
fos-PM/080	254mm long
fos-PM/081	310mm long

Treves Dissecting Forceps

200mm long

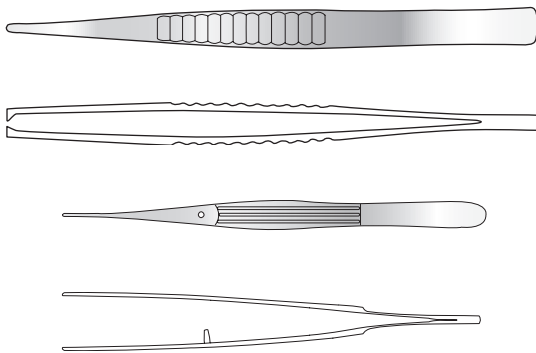

Code	Description
fos-PM/084	1-2 teeth
fos-PM/086	2-3 teeth

Jean Dissecting Forceps

177mm long

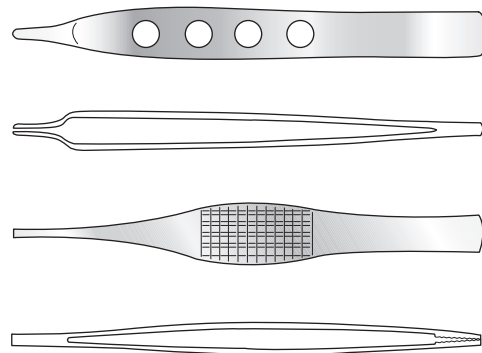

Code	Description
fos-PM/097	Serrated
fos-PM/098	1-2 teeth



McIndoe Dissecting Forceps

152mm long

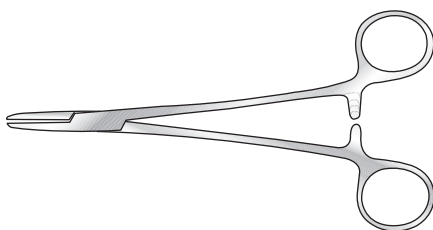

Code	Description
fos-£476	Serrated
fos-£477	1-2 teeth

Ramsey Dissecting Forceps

177mm long

Code	Description
fos-PM/101	Serrated
fos-PM/102	1-2 teeth
fos-PM/103	2-3 teeth

Mayo Hegar Needle Holder

Code	Description
fos-£244	159mm long
fos-PM/36c	178mm long
fos-£398	203mm long

Forceps, Clamps and Raspatory

Spencer Wells Artery Forceps

Straight

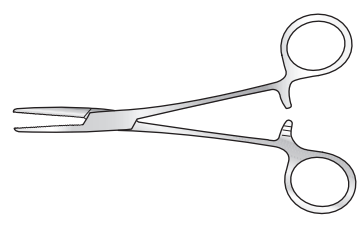

Code	Description
fos-£035	127mm long
fos-£036	152mm long
fos-£037	177mm long
fos-£038	203mm long

Spencer Wells Artery Forceps

Curved

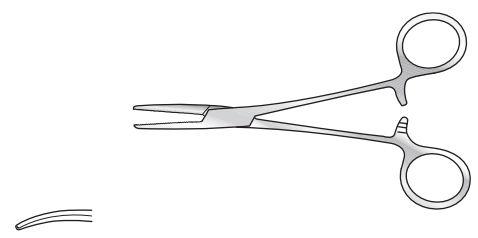

Code	Description
fos-£039	127mm long
fos-£040	152mm long
fos-£041	177mm long
fos-£042	203mm long

Dura Mater Stripping Forceps

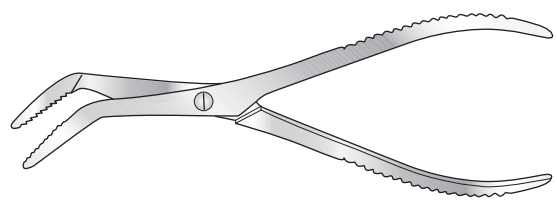

Code	Description
fos-PM/091	203mm long

Lane Bowel Clamp

Stainless steel, straight

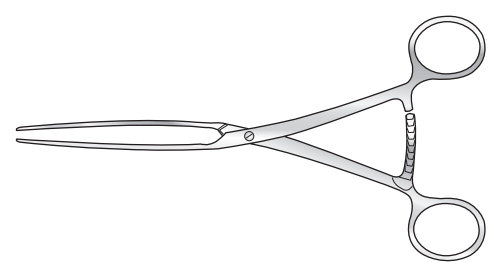

Code	Description
fos-PM/087	177mm long

Raspatory

For scalp

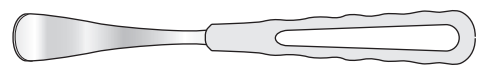

Code	Description
fos-PM/090	175mm long

Saws

Fixed Back Saw

14 teeth per inch

Code	Description
fos-PM/105	Blade length 228mm
fos-PM/107	Blade length 254mm

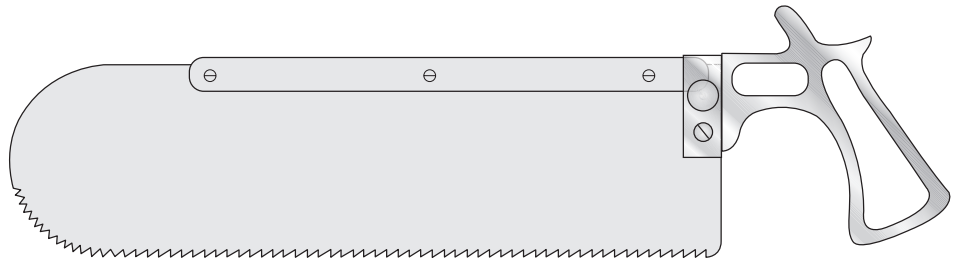

Barnard's Saw

14 teeth per inch

Code	Description
fos-PM/104	Blade length 279mm

Hinged Back Saw

14 teeth per inch

Code	Description
fos-PM/106	Blade length 228mm
fos-PM/108	Blade length 254mm

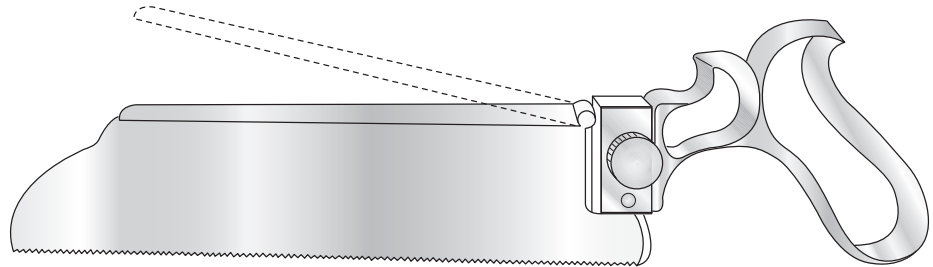

Spinal Saw

Fixed back, double bladed, adjustable

Code	Description
fos-PM/109	Blade length 152mm, 297mm long

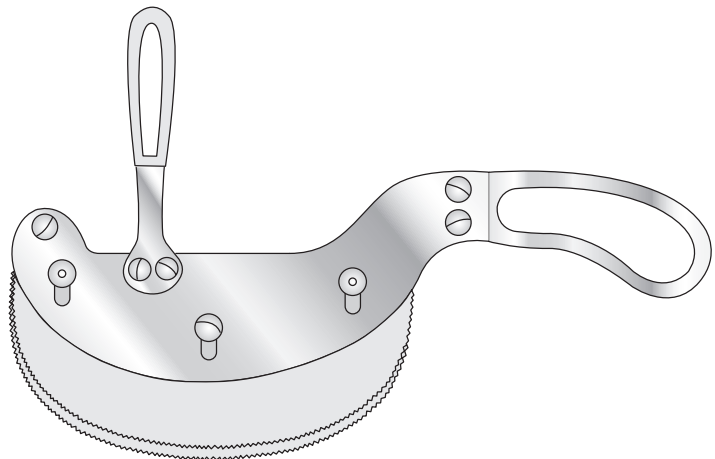

Amputation Saw

Fixed back, with shaped end

Code	Description
fos-PM/110	Blade length 254mm

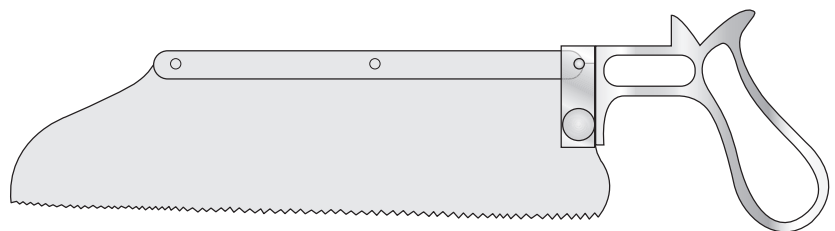

Gouge

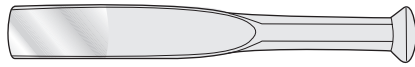

Code	Description
fos-PM/133	Blade 19mm

Chisel

Straight

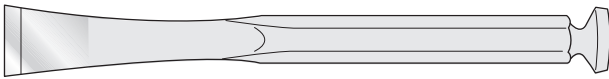

Code	Description
fos-PM/130	Blade 12mm
fos-PM/131	Blade 19mm
fos-PM/132	Blade 25mm

Spinal Chisel

With locating point

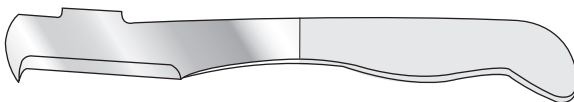

Code	Description
fos-PM/135	180mm

Chisel

T shaped

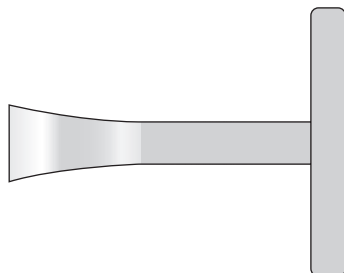

Code	Description
fos-PM/137	23mm blade, 100mm long
fos-PM/138	25mm blade, 127mm long

Vertebrae Chisel

Angled

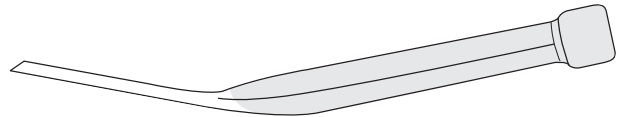
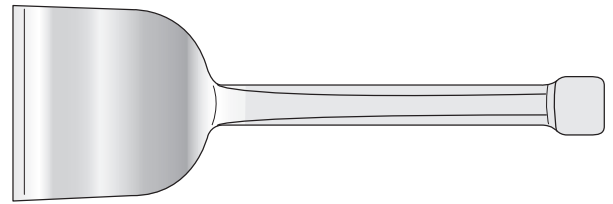

Code	Description
fos-PM/136	Blade 76mm

Vertebrae/Bone Chisel

Angled, with blue acetic "Suregrip" handles

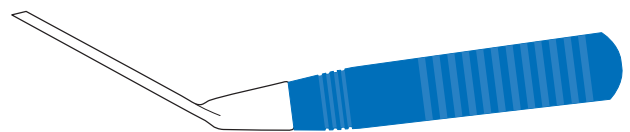
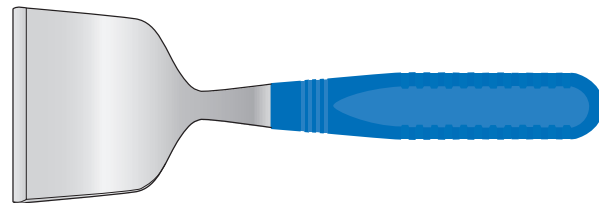

Code	Description
fos-PM/136B	Blade 76mm

Mallets, Probes, Retractors, Needles

Rubber Mallet

With wooden handle
305mm long



Code	Description
fos-PM/142	300 grams

Mallet

Army pattern, lead filled

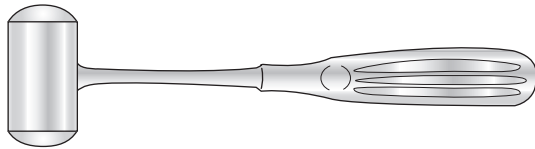

Code	Description
fos-PM/141	200mm long

Hammer

Wrench end

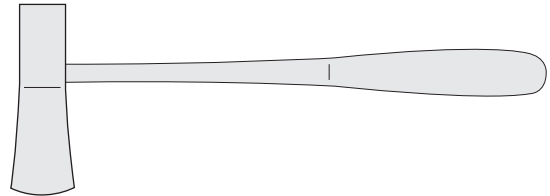

Code	Description
fos-PM/140	200mm long

Silver Plated Probe

With eye



Code	Description
fos-£289	152cm long
fos-£291	203mm long
fos-£292	255mm long

Silver Probe

Fish tail



Code	Description
fos-£294	152cm long
fos-£295	203mm long
fos-£296	255mm long

Durham Retractor

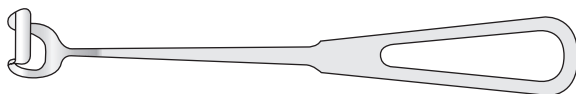

Code	Description
fos-PM/121	215mm long

Scalpel Blade Remover

Serrated

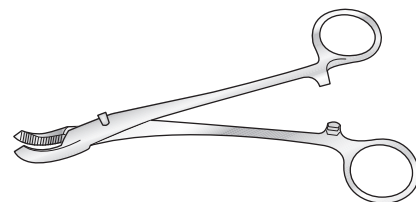

Code	Description
fos-PM/128	148mm long



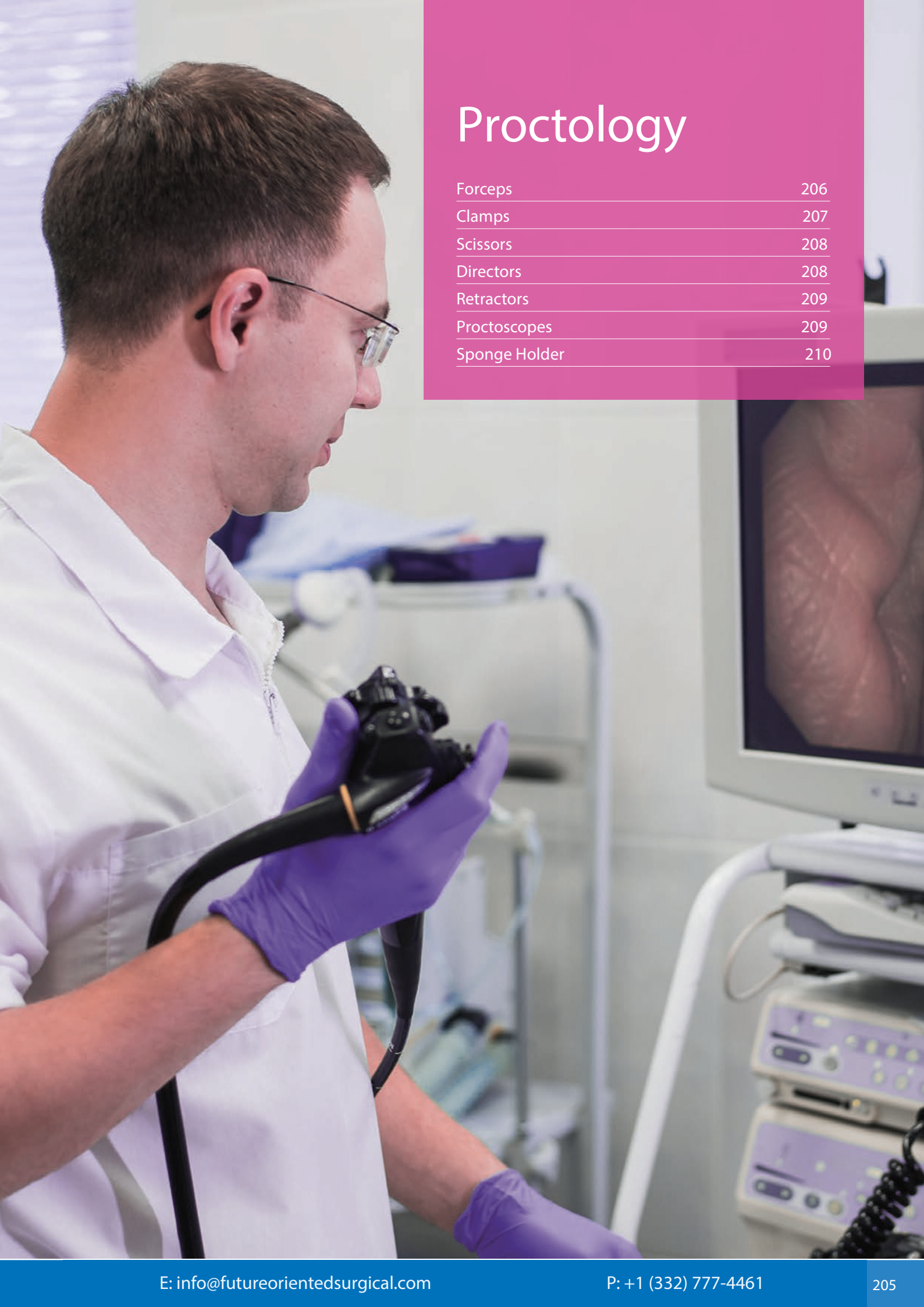

Proctology

Forceps	206
Clamps	207
Scissors	208
Directors	208
Retractors	209
Proctoscopes	209
Sponge Holder	210

Forceps

Officer Biopsy Forceps

With 8mm cup jaw, to use through a sigmoidoscope

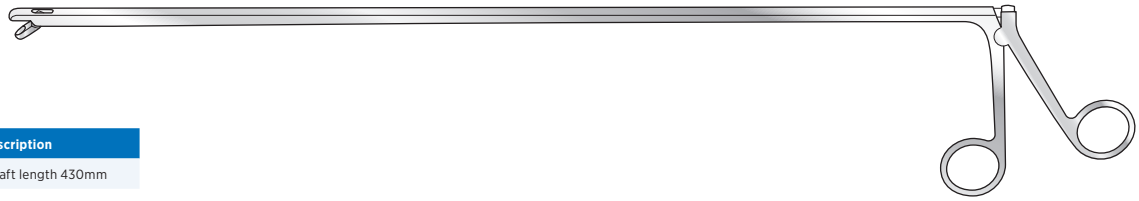

Code	Description
fos-PR/001	Shaft length 430mm

Yeoman Basket

Jawed to use through a sigmoidoscope

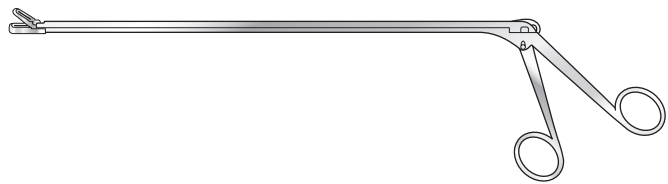

Code	Description
fos-PR/002a	Shaft length 250mm
fos-PR/002b	Shaft length 355mm
fos-PR/002c	Shaft length 430mm

Lloyd-Davis Sigmoidoscope

Biopsy forceps

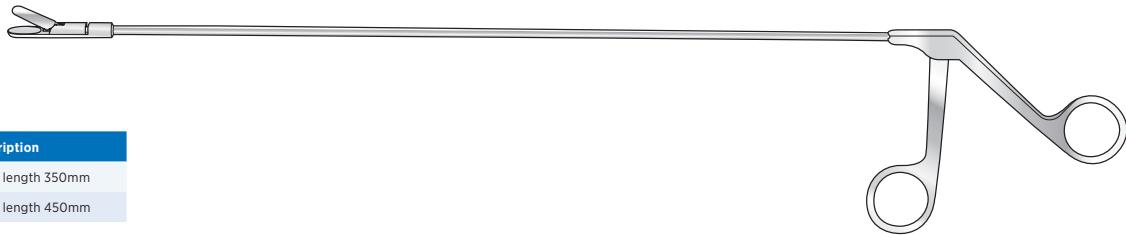

Code	Description
fos-PR/020a	Shaft length 350mm
fos-PR/020b	Shaft length 450mm

Walton Rectal Biopsy Forceps

With laterally angled shanks

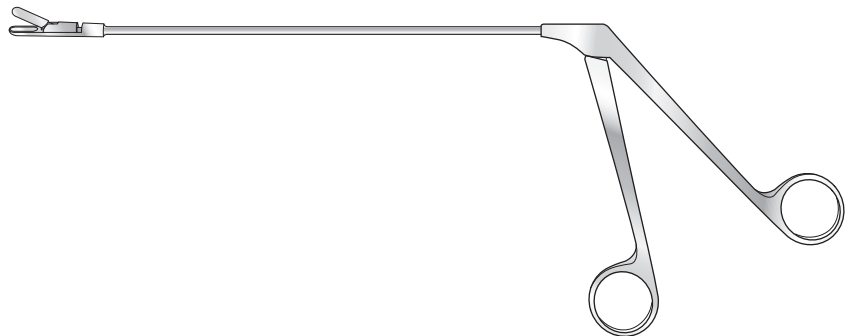

Code	Description
fos-PR/022	Shaft length 203mm

Officer Dissecting Forceps



Code	Description	Code	Description
fos-PR/008a	2-3 fine teeth, 150mm long	fos-PR/008c	4-5 fine teeth, 200mm long
fos-PR/008b	2-3 fine teeth, 200mm long	fos-PR/008d	4-5 fine teeth, 250mm long

Lloyd-Davis Rectal Occlusion Forceps

With longitudinal serrations

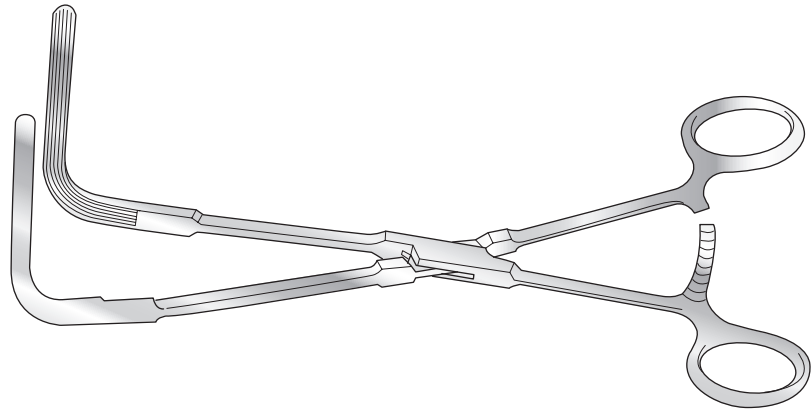

Code	Description
fos-PR/023	300mm long

Finch Excision Clamp

With hollowed jaws

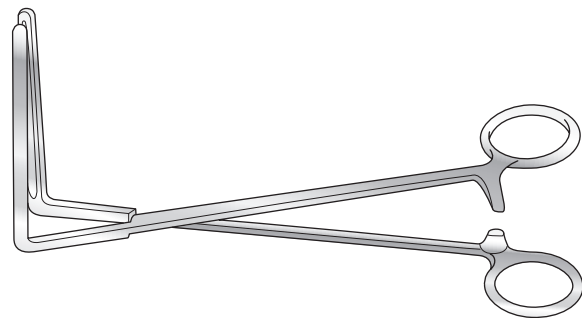

Code	Description
fos-PR/003	75mm blade, 215mm long

Hays Colon Resection Clamp

Angled at 70°

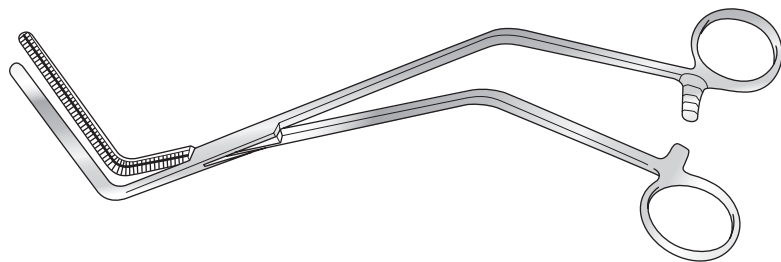

Code	Description
fos-PR/004a	Jaw length 80mm 270mm long
fos-PR/004	Jaw length 100mm 285mm long

Scissors and Directors

Abel Abdominal-Perineal Scissors

Straight

Code	Description
fos-PR/016	320mm long

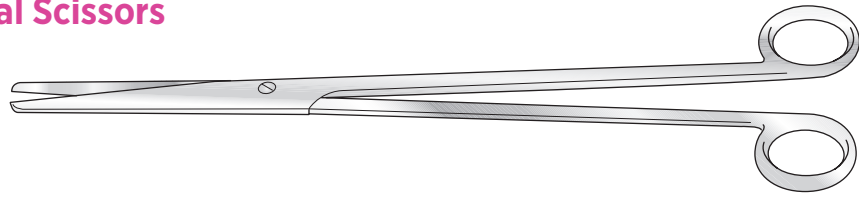

Goligher Scissors

Straight

Code	Description
fos-PR/017a	300mm long
fos-PR/017b	330mm long

Curved

Code	Description
fos-PR/017c	300mm long
fos-PR/017d	330mm long

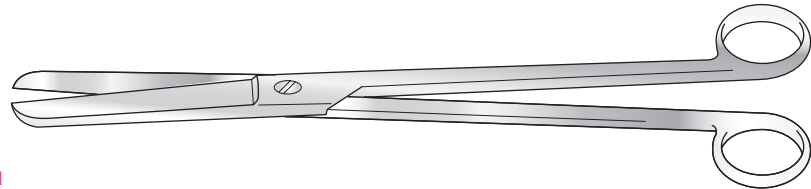

Lloyd-Davis Rectal Scissors

Flattened blades, blunt points
265mm long

Code	Description
fos-PR/018a	Straight
fos-PR/018b	Curved on flat

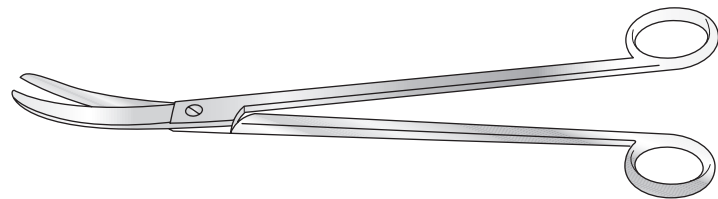

St Mark's Rectal Dilator

Code	Description
fos-PR/005a	Small, 14mm x 19mm
fos-PR/005b	Large, 16mm x 25mm



Lockhart Mummery Fistula Director

165mm long

Straight

Code	Description
fos-PR/006a1	With 1mm hole



90° curve

Code	Description
fos-PR/006c1	With 1mm hole



45° curve

Code	Description
fos-PR/006b	With 1mm hole



Retrograde

Code	Description
fos-PR/006d1	With 1mm hole



Lloyd-Davis Retractor

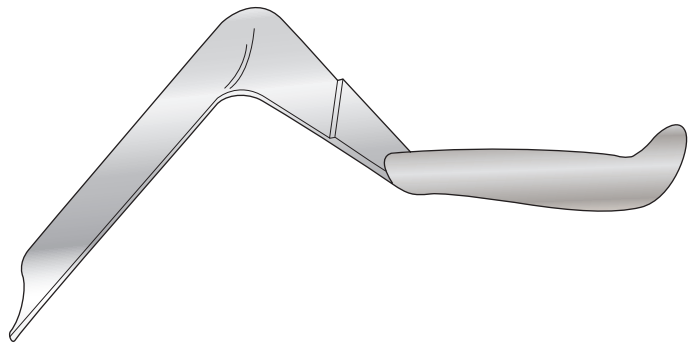

Code	Description
fos-PR/013a	Short, without tapered end, 125mm x 55mm
fos-PR/013b	Long, with tapered end, 170mm x 65mm x 50mm

Park Combined Anal Retractor

Self retaining, with 2 sets of interchangeable blades and one adjustable centre blade

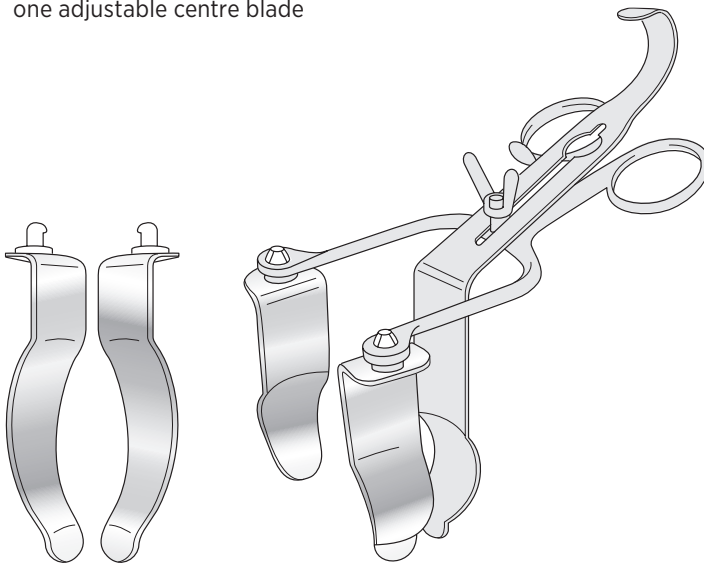

Code	Description
fos-PR/015	140mm long

Park Anal Retractor

Self retaining

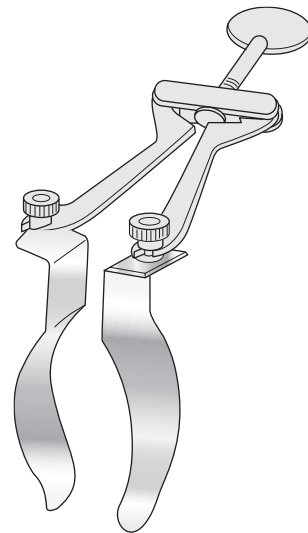

Code	Description
fos-PR/014	130mm, 95mm

Kelly Proctoscope

With obturator, lumen

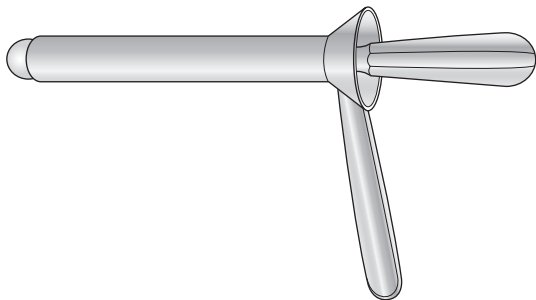

Code	Description
fos-PR/012a	140mm long
fos-PR/012b	200mm long
fos-PR/012c	Tapered, 22mm ø, x 100mm

Eisenhammer Speculum

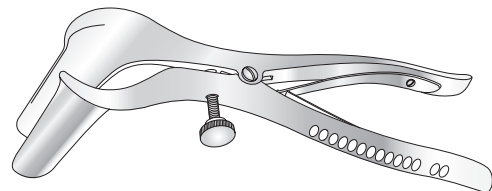

Code	Description
fos-SH/4120	Blade 70mm long x 20mm wide
fos-SH/41201	Blade 95mm long x 20mm wide

Sponge Holder

Sponge Holder

With spring handle

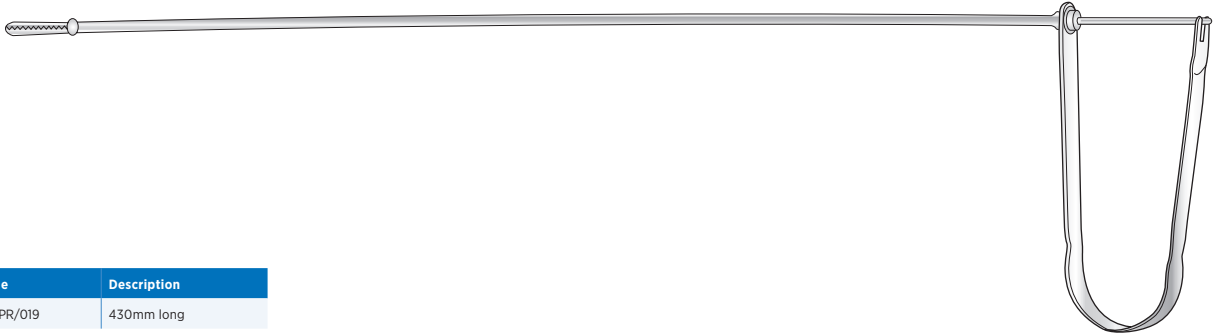

Code	Description
fos-PR/019	430mm long



Thoracic

Artery Clamps	212
Clamps	214
Bulldog Clamps	219
Scissors	220
Needle Holders	221
Retractors	222
Rib Spreaders	223
Rib Shears	226
Lung Forceps	226
Elevators	227
Miscellaneous	227

Artery Clamps

DeBakey Bainbridge Clamps

Box joint, atraumatic, haemostatic

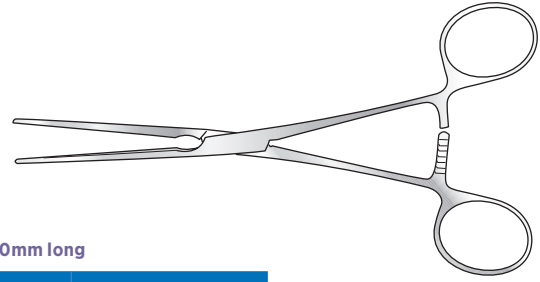

180mm long

Code	Description
fos-GI/078	Straight
fos-GI/077	Curved

DeBakey Bainbridge Clamps

Box joint, atraumatic

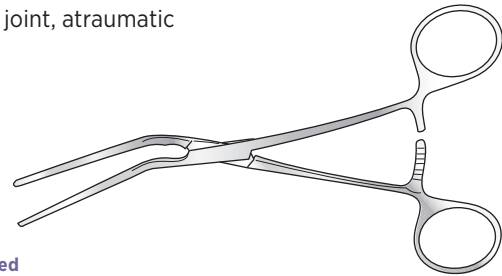

Curved

Code	Description
fos-GI/079	165mm long

DeBakey Bainbridge Clamps

Box joint, atraumatic, haemostatic

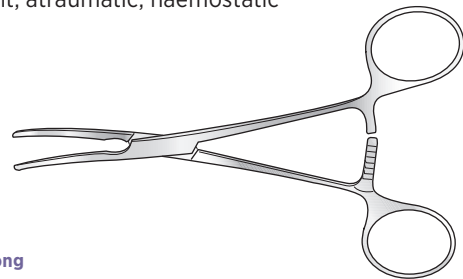

155mm long

Code	Description
fos-GI/105	Curved
fos-GI/106	Straight

Cooley Artery Clamps

Box joint, atraumatic, curved

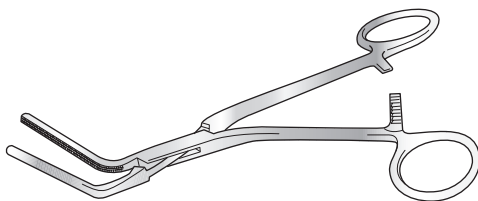

Code	Description
fos-GI/071	160mm long
fos-GI/072	200mm long

Large, strongly curved 90°

Code	Description
fos-GI/074	140mm long

Large, curved 60°

Code	Description
fos-GI/073	150mm long

Curved 30°

Code	Description
fos-GI/075	160mm long

DeBakey Clamps

Box joint, atraumatic

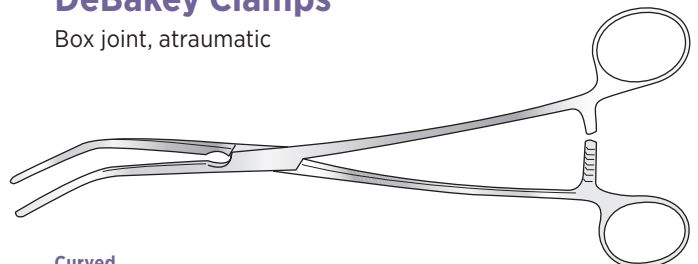

Curved

Code	Description
fos-GI/086	230mm long

DeBakey Clamps

Box joint, atraumatic

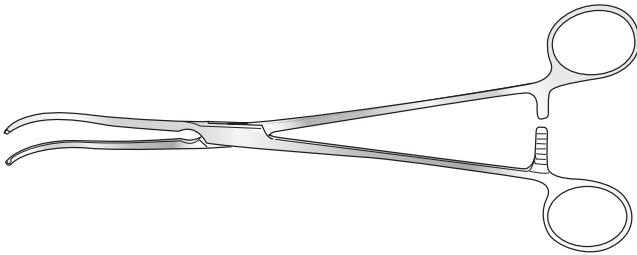

Curved

Code	Description
fos-GI/088	230mm long
fos-GI/089	240mm long
fos-GI/090	245mm long

DeBakey Clamps

Box joint, atraumatic

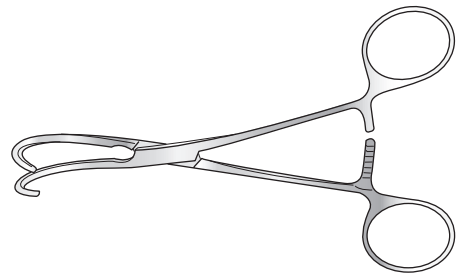

Curved

Code	Description
fos-GI/094	150mm long

DeBakey Clamps

Box joint, atraumatic

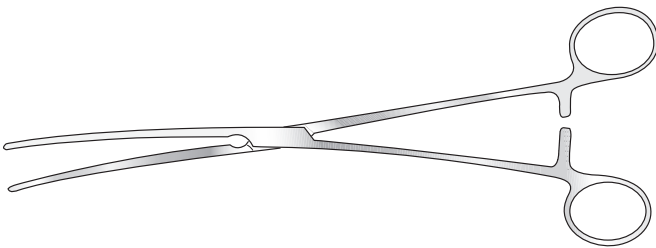

Curved

Code	Description
fos-GI/091	250mm long
fos-GI/092	270mm long
fos-GI/093	280mm long

DeBakey Clamps

Box joint, atraumatic

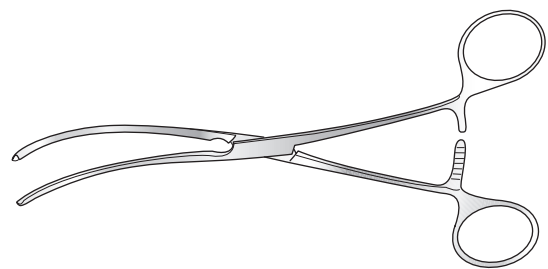

Curved

Code	Description
fos-GI/096	180mm long
fos-GI/097	203mm long

DeBakey Clamps

Box joint, atraumatic, straight

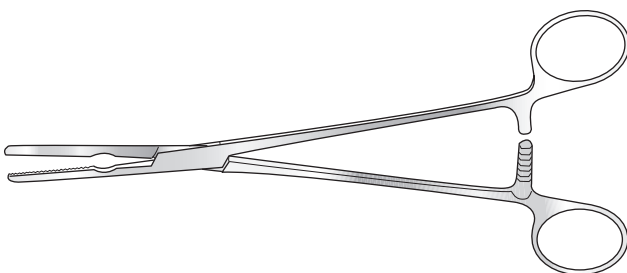

Curved

Code	Description
fos-GI/100	160mm long
fos-GI/104	165mm long
fos-GI/101	203mm long
fos-GI/098	215mm long
fos-GI/102	220mm long
fos-GI/103	230mm long
fos-GI/099	245mm long

DeBakey Clamps

Box joint, atraumatic

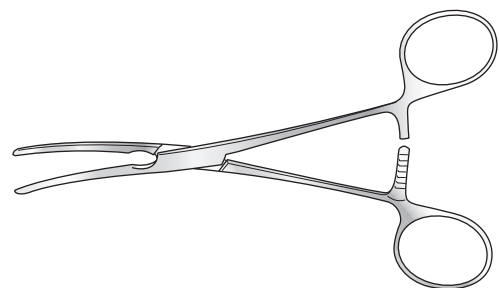

Curved

Code	Description
fos-GI/080	165mm long
fos-GI/081	190mm long
fos-GI/082	203mm long
fos-GI/083	215mm long
fos-GI/084	220mm long

Clamps

Duval Lung Grasping Clamps

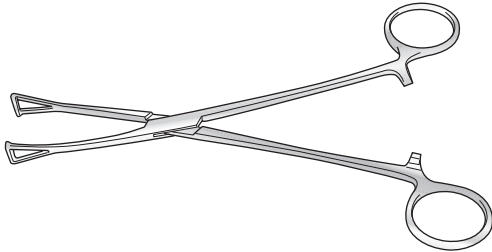

Code	Description
fos-T0033	185mm long

Tudor Edwards Artery Clamps

Curved, serrated jaws, screw joint, satin finish

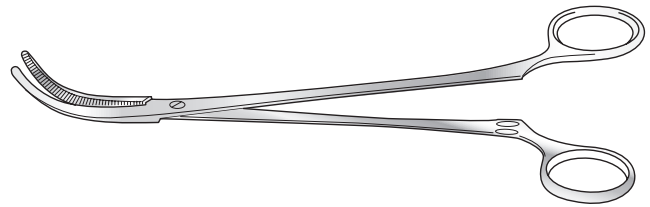

Code	Description
fos-T0015	230mm long

Babcock Lung Grasping Clamps

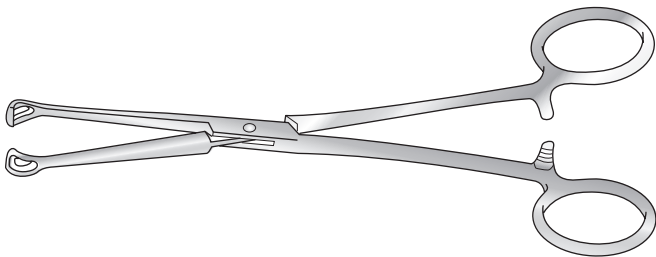

Code	Description
fos-T0034	245mm long

O'Shaughnessy Artery Clamps

Right angled serrated jaw

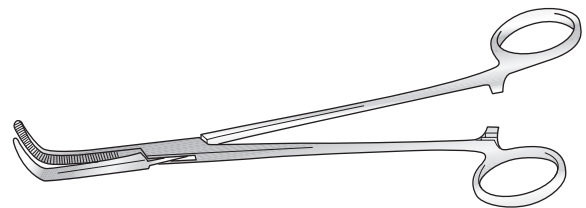

Code	Description
fos-T0036a	150mm long
fos-T0036b	180mm long
fos-T0036c	200mm long
fos-T0036d	230mm long

DeBakey Atraumatic Dissecting Clamps

Straight, atraumatic jaws

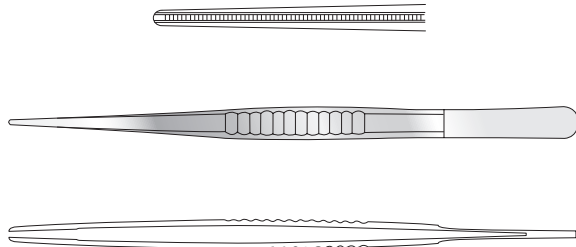

1.5mm

Code	Description
fos-GI/238a	150mm long
fos-GI/240a	240mm long

2.5mm

Code	Description
fos-GI/238b	150mm long
fos-GI/240b	240mm long

2mm

Code	Description
fos-GI/238	150mm long
fos-GI/241	180mm long

2.8mm

Code	Description
fos-GI/238c	150mm long
fos-GI/240c	240mm long
fos-GI/241c	180mm long

Magill Intratracheal Catheter Clamps

Screw joint

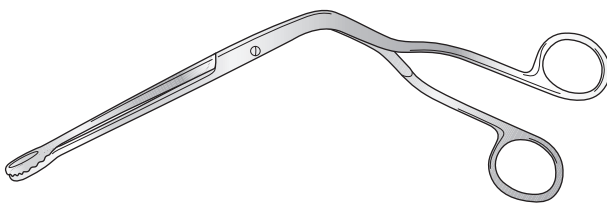

Code	Description
fos-T#032	Infant, 160mm long
fos-T#032a	Child, 190mm long
fos-T#032b	Adult, 230mm long

SEMB Ligature Passing Clamps

240mm long

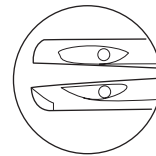
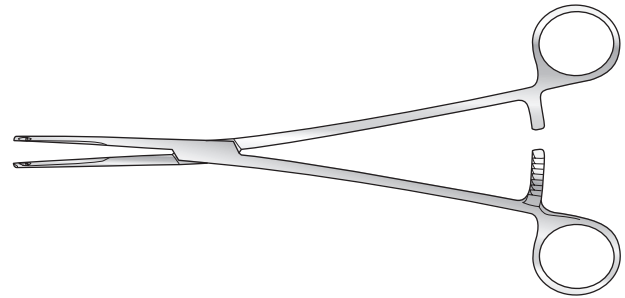

Code	Description
fos-T#044	Slightly curved
fos-T#045	Fully curved

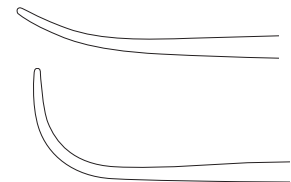

Lambert-Kay Clamp

Atraumatic

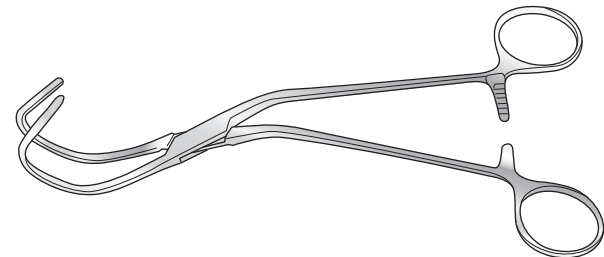

Code	Description
fos-T#029a	Curved, 220mm long
fos-T#029b	Straight, 215mm long
fos-T#029c	Straight, 200mm long

Leland-Jones Clamp

Atraumatic, hemostatic

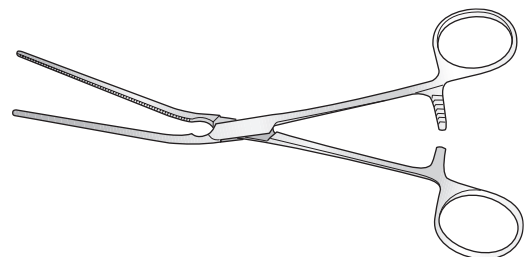

Code	Description
fos-T#023a	Curved, 190mm long
fos-T#023b	Straight, 195mm long

Clamps

DeBakey Clamp

Straight jaws, ring handle

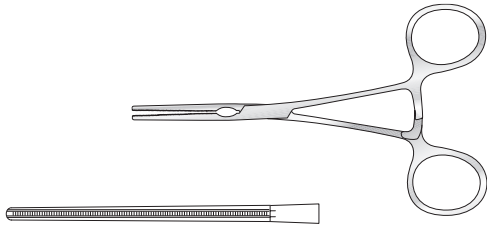

Code	Description
fos-T#048	137mm long

DeBakey Clamp

'S' shaped curved jaws, curved shaft, ring handle

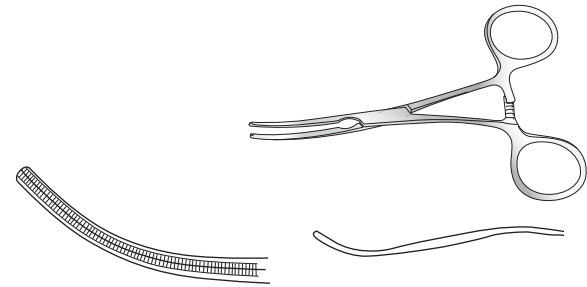

Code	Description
fos-T#049	127mm long

DeBakey "S" Shaped Clamp

300mm long

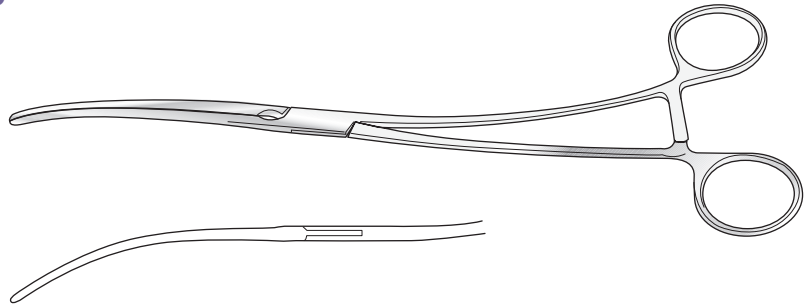

Code	Description
fos-T#096	115mm jaws

DeBakey Atraumatic Clamp

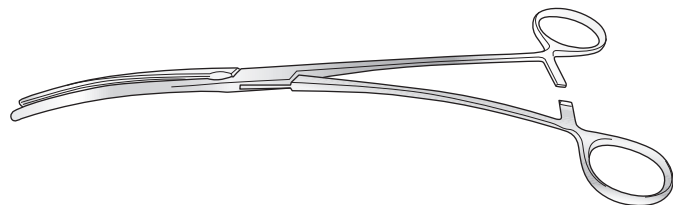

Code	Description
fos-T#090	110mm jaw, 300mm long
fos-T#092	95mm jaw, 250mm long

DeBakey Atraumatic Clamp

Right-angled, 40mm jaw

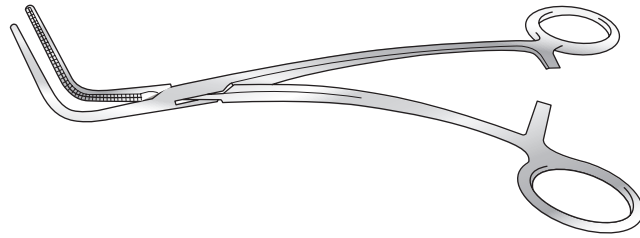

Code	Description
fos-T044a	220mm long

DeBakey Atraumatic Clamp

Right-angled, 50mm jaw

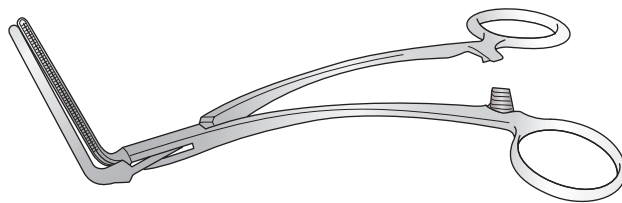

Code	Description
fos-T045	200mm long

DeBakey Atraumatic Clamp

Right-angled, 65mm jaw

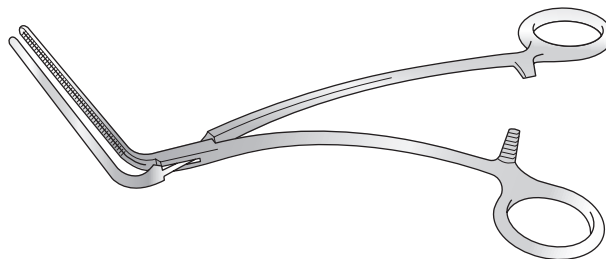

Code	Description
fos-T046	215mm long

DeBakey Atraumatic Clamp

Right-angled, 100mm jaw

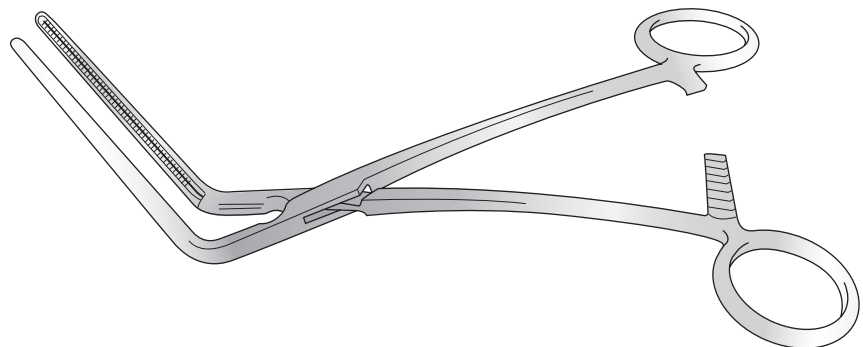

Code	Description
fos-T047	280mm long

Clamps

DeBakey Coarctation Clamp

Angled, 225mm long

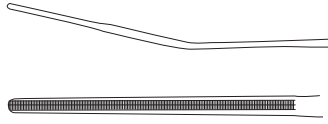

Code
fos-T#052

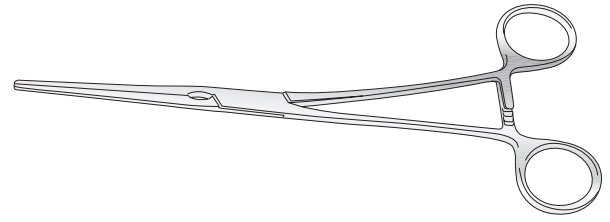

DeBakey Multipurpose Clamp

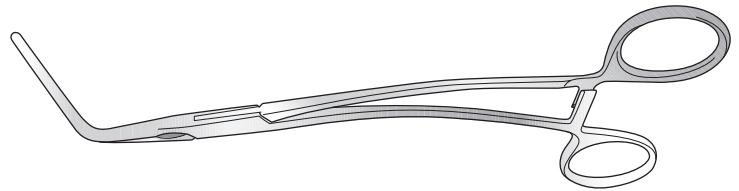
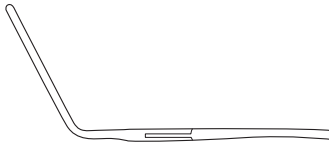

Code	Description
fos-T#095	85mm jaw, 230mm long
fos-T#064	100mm jaw, 280mm long

DeBakey Multipurpose Clamp

Obtuse angled 60°, 280mm long

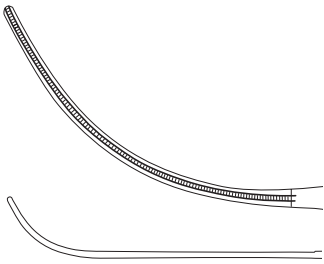

Code
fos-T#053

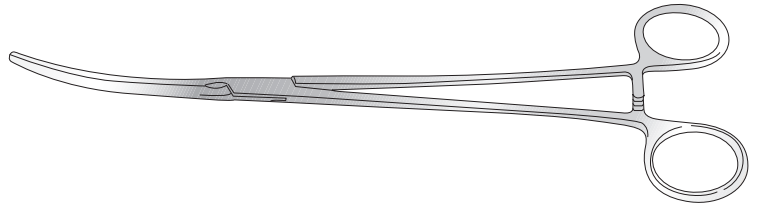

DeBakey 45° Paediatric Clamp

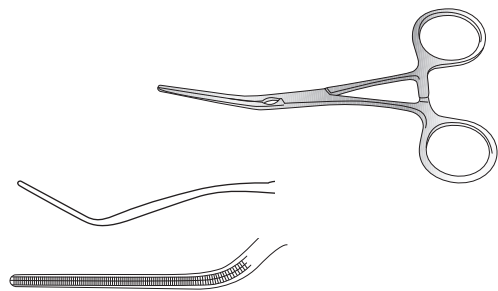

Code	Description
fos-T#050	130mm long

DeBakey 90° Paediatric Clamp

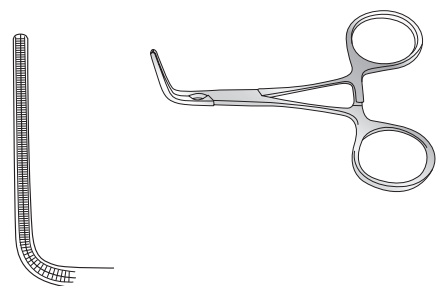

Code	Description
fos-T#051	105mm long

Dieffenbach Bulldog Clamp

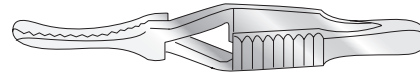
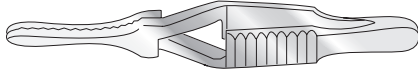

Straight, serrated

Code	Description
fos-GI/112	1.2mm fine jaw, 40mm long
fos-GI/113	1.2mm fine jaw, 45mm long
fos-GI/108	1.8mm jaw, 30mm long
fos-GI/109	1.8mm jaw, 35mm long
fos-GI/110	2.5mm jaw, 40mm long
fos-GI/111	2.5mm jaw, 45mm long
fos-GI/107	6mm heavy jaw, 60mm long
fos-GI/455	20mm jaw, 75mm long
fos-GI/455a	30mm jaw, 85mm long
fos-GI/455b	45mm jaw, 105mm long
fos-GI/455c	65mm jaw, 120mm long

Straight, plain

Code	Description
fos-GI/129	1.2mm fine jaw, 40mm long
fos-GI/131	1.2mm fine jaw, 45mm long
fos-GI/121	1.8mm jaw, 30mm long
fos-GI/123	1.8mm jaw, 35mm long
fos-GI/125	2.5mm jaw, 40mm long
fos-GI/127	2.5mm jaw, 45mm long

Curved, serrated

Code	Description
fos-GI/119	1.2mm fine jaw, 40mm long
fos-GI/120	1.2mm fine jaw, 45mm long
fos-GI/115	1.8mm jaw, 30mm long
fos-GI/116	1.8mm jaw, 35mm long
fos-GI/117	2.5mm jaw, 40mm long
fos-GI/118	2.5mm jaw, 45mm long
fos-GI/114	6mm heavy jaw, 60mm long
fos-GI/456	20mm jaw, 75mm long
fos-GI/456a	30mm jaw, 85mm long
fos-GI/456b	45mm jaw, 105mm long
fos-GI/456c	65mm jaw, 120mm long

Curved, plain

Code	Description
fos-GI/130	1.2mm fine jaw, 40mm long
fos-GI/132	1.2mm fine jaw, 45mm long
fos-GI/122	1.8mm jaw, 30mm long
fos-GI/124	1.8mm jaw, 35mm long
fos-GI/126	2.5mm jaw, 40mm long
fos-GI/128	2.5mm jaw, 45mm long

Blalock Bulldog Clamp



Serrated, with hole in handle

Straight

Code	Description
fos-GI/480	11mm jaw, 38mm long
fos-GI/482	14mm jaw, 48mm long
fos-GI/493	17mm jaw, 60mm long
fos-GI/481	27mm jaw, 70mm long

Curved

Code	Description
fos-GI/478	11mm jaw, 38mm long
fos-GI/479	14mm jaw, 48mm long
fos-GI/491	17mm jaw, 60mm long
fos-GI/492	27mm jaw, 70mm long

Diethrich Bulldog Clamp

Angled 12mm jaw

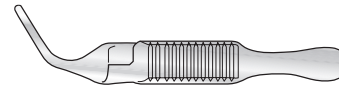

Code	Description
fos-BGI/8097	44mm long

Plain, with hole in handle

Straight

Code	Description
fos-GI/486	11mm jaw, 38mm long
fos-GI/487	14mm jaw, 48mm long
fos-GI/488	17mm jaw, 60mm long
fos-GI/489	27mm jaw, 70mm long

Curved

Code	Description
fos-GI/483	11mm jaw, 38mm long
fos-GI/484	14mm jaw, 48mm long
fos-GI/485	17mm jaw, 60mm long
fos-GI/490	27mm jaw, 70mm long

Scissors

Potts Scissors

Satin finish, 190mm long

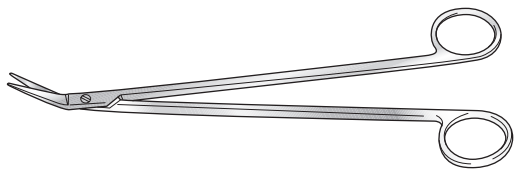

Code	Description
fos-T#019	Angled on flat 45°
fos-T#020a	Angled to side 45°
fos-T#020b	Acute angle to side

Potts Diethrich Scissors

Supercut, 190mm long

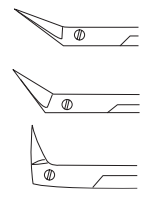
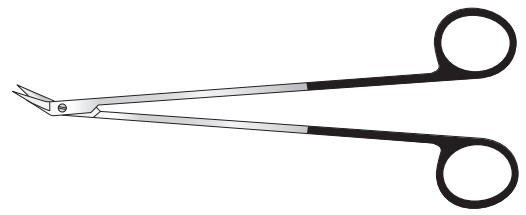

Code	Description
fos-T#078	25° angled on side
fos-T#079	45° angled on side
fos-T#080	90° angled on side

Diethrich Circumflex Artery Scissors

Supercut, 175mm long

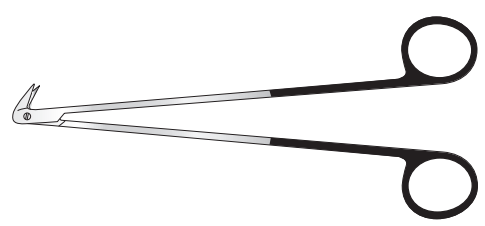

Code	Description
fos-T#077	125° angled on side

Boyd Scissor

Supercut, slight curve

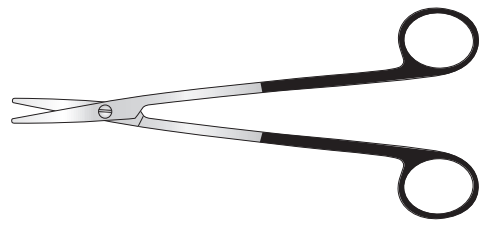

Code	Description
fos-T#047	180mm long

Lobectomy Scissors

Curved on flat

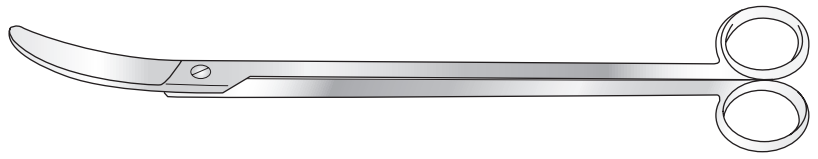

Code	Description
fos-T#001b	305mm long

Nelson Lobectomy Scissor

Tungsten carbide, curved on flat, 230mm long

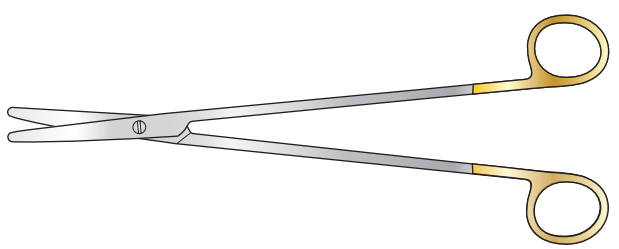

Code
fos-T#057

Needle Holder and Wire Twister

For sternum wire, left-handed, 300mm long

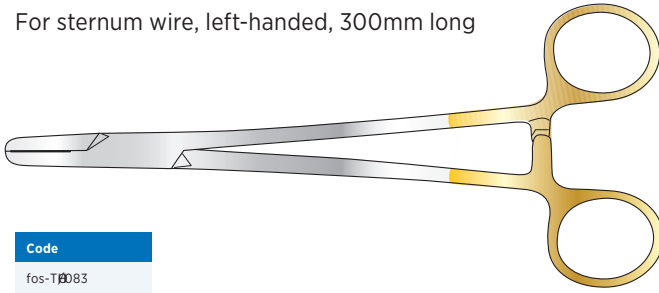

Code
fos-T#083

Julian Needle Holder

Light, delicate model, with tungsten carbide jaws
220mm long

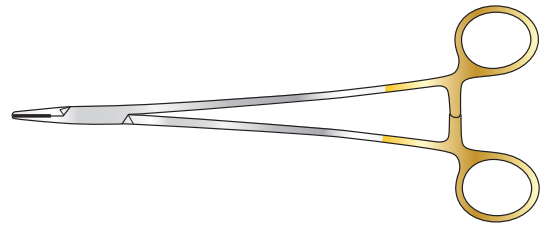

Code	Description
fos-T#081	
fos-T#081a	Left-handed

Rochester Needle Holder

Light, delicate model, with tungsten carbide jaws
190mm long

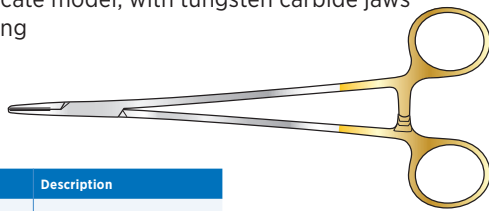

Code	Description
fos-T#082	
fos-T#082a	Left-handed

DeBakey Needle Holder

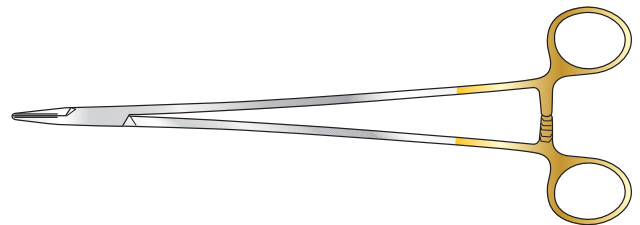

Stratte Needle Holder

210mm long

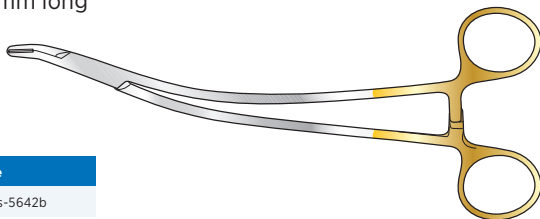

Code
T#fos-5642b

Code	Description
T#fos-5642a	250mm long
fos-GI/502A	165mm very delicate
fos-GI/502	180mm tungsten carbide
SH003944	260mm long straight with tungsten carbide inserts
fos-5642A	240mm long
fos-GI/036BM	Tungsten carbide delicate 230mm long
fos-GI/037BM	Tungsten carbide delicate 250mm long
fos-GI/038BM	Tungsten carbide delicate 305mm long

Castroviejo Needle Holder

Code	Description
fos-#021	140mm long, with catch
fos-#020	140mm long, without catch

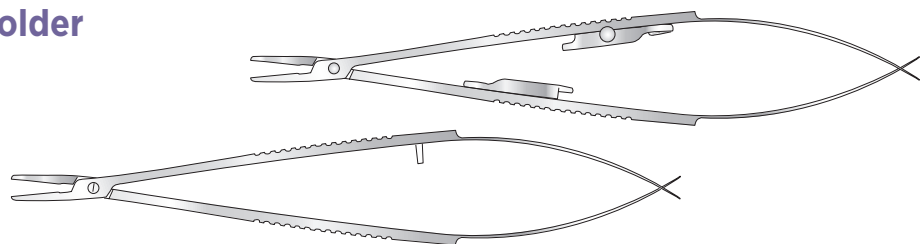

Diamond dust jaws

Code	Description
fos-T#060	180mm long, without catch
fos-T#061	200mm long, without catch
fos-T#062	215mm long, without catch



ALSO AVAILABLE WITH CATCH - ADD SUFFIX CTH TO CODE

Tungsten carbide jaws

Code	Description
fos-T#058a	180mm long
fos-T#058	200mm long
fos-T#059	215mm long

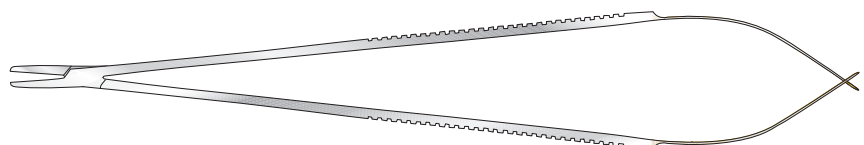

ALSO AVAILABLE WITH CATCH - ADD SUFFIX CTH TO CODE

Retractors

Blanco Valve Leaflet Retractor

280mm long



Code
fos-T0041

Harrington Splanchnic Retractor

Small size, end of blade
38mm wide x 127mm deep
satin finish handle

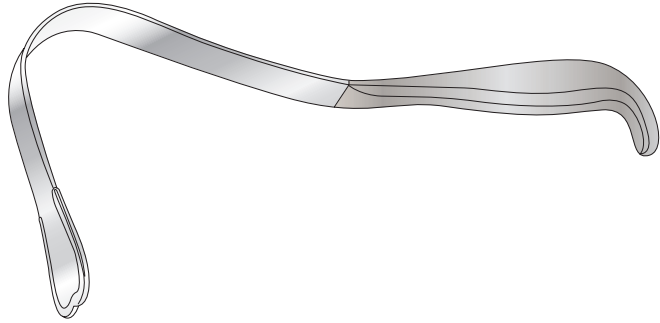

Code	Description
fos-T0011	320mm long

Brocks Erecton Spinal Back End Retractor

215mm long

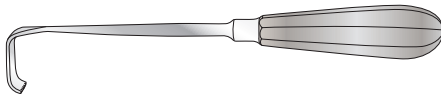

Code	Description
fos-T0054	13 x 28mm

Cleland Valve Leaflet Retractor

250mm long



Code
fos-T0097

Ross Retractor

250mm long

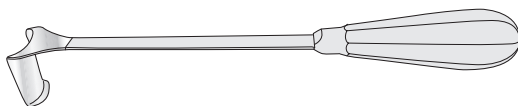

Code	Description	Code	Description
fos-T0089	16mm x 15mm blade	fos-T0089c	27mm x 13mm blade
fos-T0089a	23mm x 13mm blade	fos-T0089d	27mm x 27mm blade
fos-T0089b	24mm x 16mm blade	fos-T0089e	25mm x 38mm blade

Tudor Edwards Retractor

25mm Wide

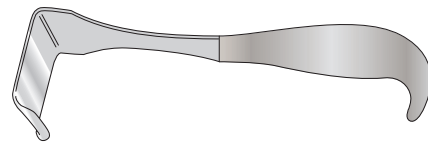

Code	Description
fos-T0013	205mm long

Allison Lung Retractor

Satin finish handle

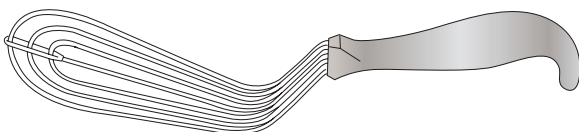

Code	Description
fos-T0012a	Infant
fos-T0012b	Child, 280mm blade
fos-T0012c	Adult, 300mm blade

Cooley Atrial Retractor

260mm overall length

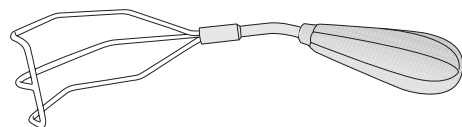

Code	Description
fos-T0046	Right
fos-T0046a	Left

Finochietto Rib Spreader

Straight arms, 20mm square blades

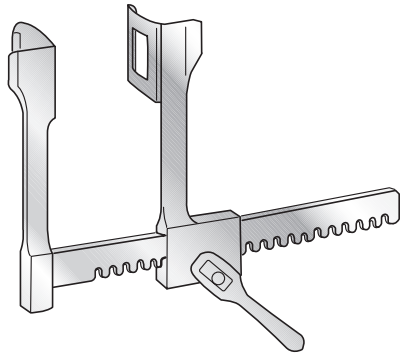

Code	Description
fos-T006	Infant, maximum opening 80mm x 60mm long
fos-T037	Adult, maximum opening 200mm, blades 44 x 65mm

Morse-Favaloro Rib Spreader

Curved arms, 275mm long

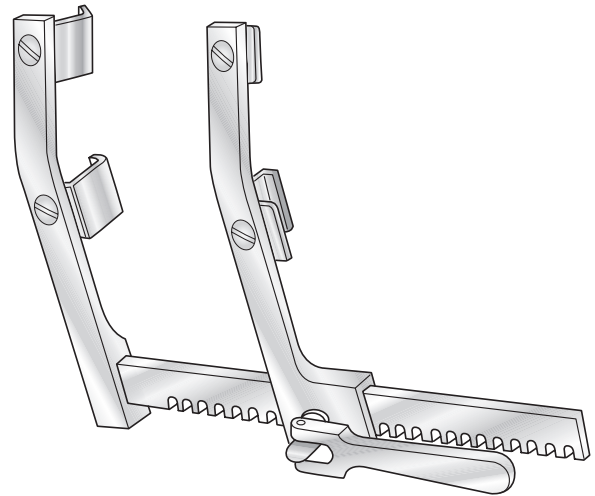

Code	Description
fos-T003	Swivel blades 215mm long
fos-T03a	Swivel blades 185mm long

IMA Rib Spreader

Converts left or right

Code	Description
fos-T002	Standard frame only
fos-T02a	Ministernotomy frame only
fos-T02b	Complete, standard, 1 x frame, 1 x 100mm long x 20mm wide U shaped blade, 1 x claw blades 28mm and 32mm deep
fos-T02c	Complete, ministernotomy, 1 x frame, 1 x 30mm long x 20mm wide U shaped blade, 1 x claw blades 43mm and 50mm deep

Claw blade only

Code	Description
fos-T02d	28mm deep
fos-T02e	32mm deep
fos-T02f	38mm deep
fos-T02g	43mm deep
fos-T02h	50mm deep

U shaped blade only

Code	Description
fos-T02i	100mm long x 20mm wide
fos-T02j	100mm long x 25mm wide
fos-T02k	30mm long x 20mm wide

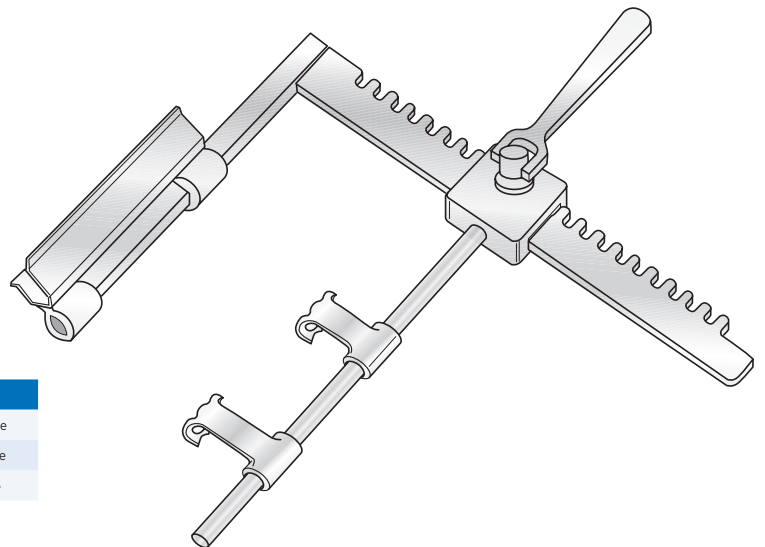

Price Thomas Rib Spreader

Code	Description
fos-T099	Complete with 3 pairs of blades, key, 250, 215, 68mm
fos-T099a	Blade only, 50mm x 38mm, pair
fos-T099b	Blade only, 50mm x 45mm, pair
fos-T099c	Blade only, 50mm x 65mm, pair
fos-T099d	Nut and bolt for blade only
fos-T099e	Frame only
fos-T099f	Key only

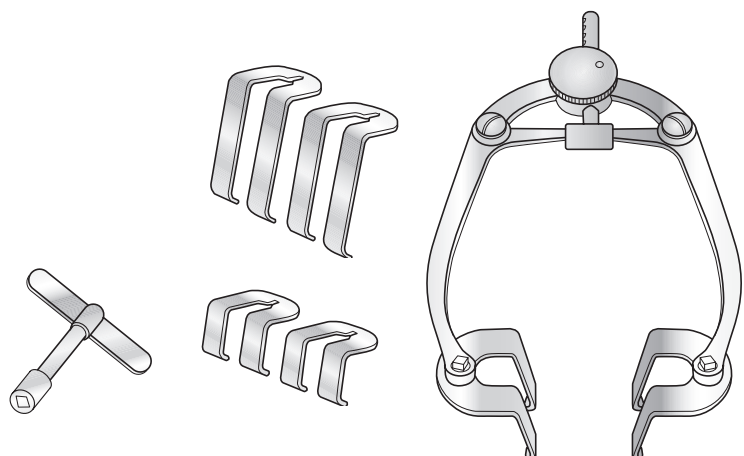

Rib Spreaders

Sellors Rib Spreader

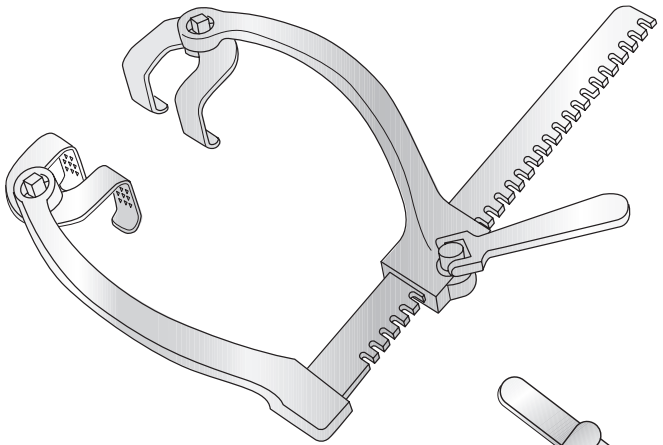

Code	Description
fos-T#00	Complete with 3 pairs of blades, key,
fos-T#00a	Blade only, 50mm x 38mm, pair
fos-T#00b	Blade only, 50mm x 45mm, pair
fos-T#00c	Blade only, 50mm x 65mm, pair
fos-T#00d	Frame only
fos-T#00e	Nut and bolt for blade only
fos-T#00f	Key only

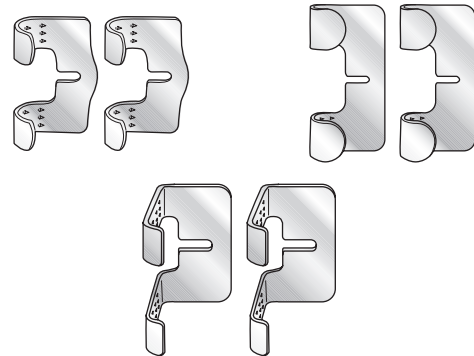
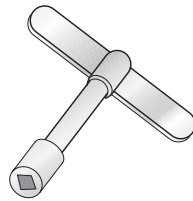

Harefield sternal blade only, pair

Code	Description
fos-T#00g	70 x 30mm
fos-T#00h	120 x 30mm

Harefield scapula blade only, pair

Code	Description
fos-T#00i	75 x 70mm

Ronald Edwards Rib Spreader

Curved arms, fenestrated

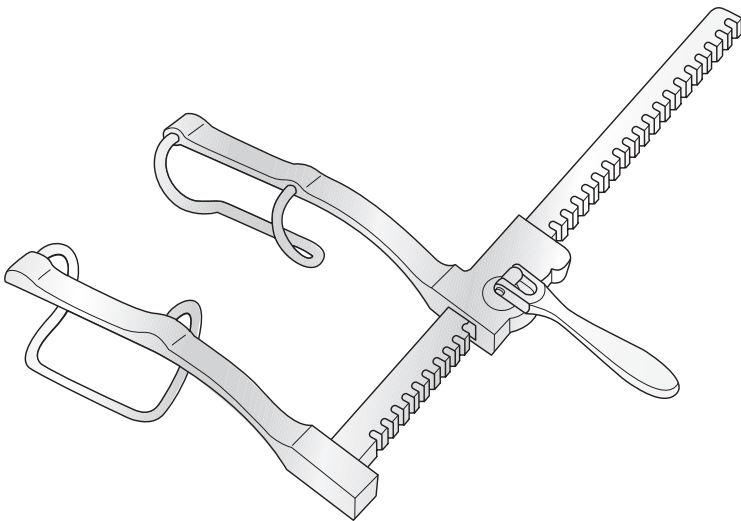

Code	Description
fos-T#04	Infant, 100mm, 25mm x 30mm blades
fos-S#5158	Child, 150mm, 30mm x 50mm blades
fos-S#6720	Adult, 245mm, 65mm x 75mm blades

Bailey Rib Approximator and Spreader

Combined, satin finish

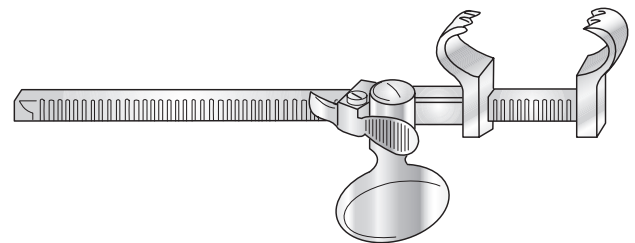

Code	Description
fos-T#003	160mm long

Sellors Rib Approximator and Spreader

Combined action, satin finish

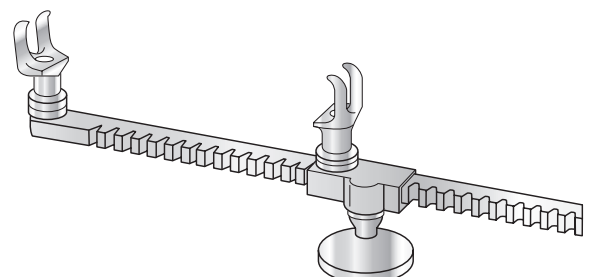

Code	Description
fos-T#002	195mm long

Cooley Rib Spreader

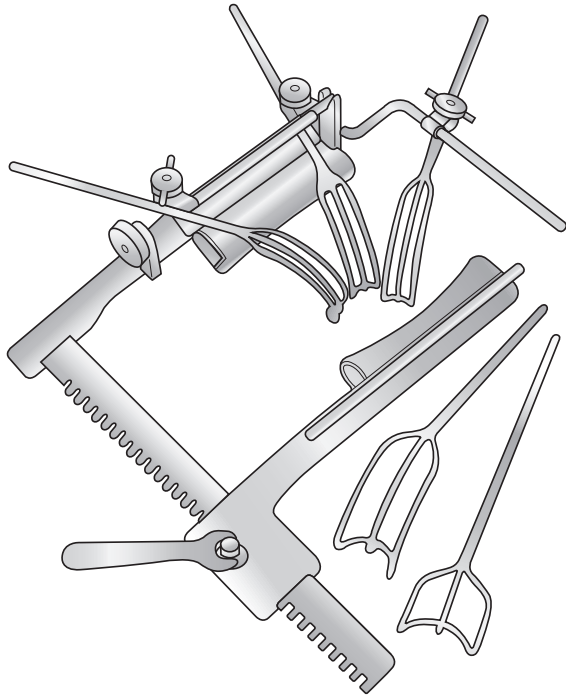

Code	Description
fos-43950-50	Adult, 40mm x 110mm blades, complete with cosgrove mounting bars
fos-43950-90	Adult, 40mm x 110mm blades, complete with cosgrove mitral valve retractor attachment, 5 x blades, 3 x clamp, 1 x side arm

Wells Rib Spreader

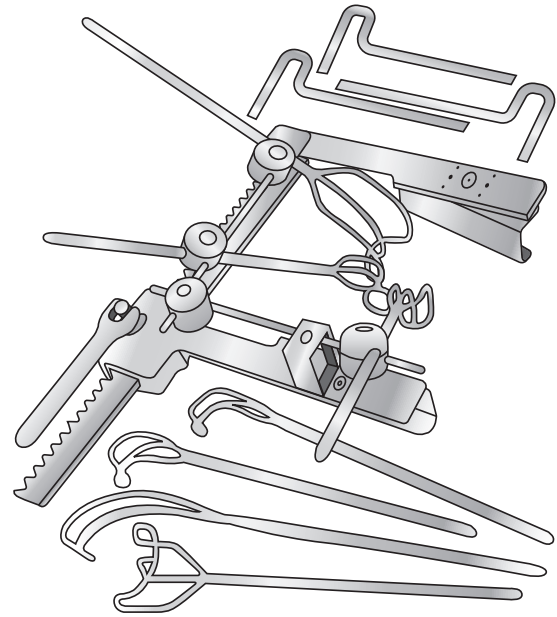

Code	Description
fos-44080-65	Small rake retractor on shaft
fos-44080-80	Frame only, 90mm wide x 25mm deep blades
fos-44080-90	Complete, frame, pillar clamp, 4 x ball clamps, 2 x mounting bars, hex keys, 1 x tricuspid rake ret, 2 x small, medium and large rake ret

Tudor Edwards Rib Spreader

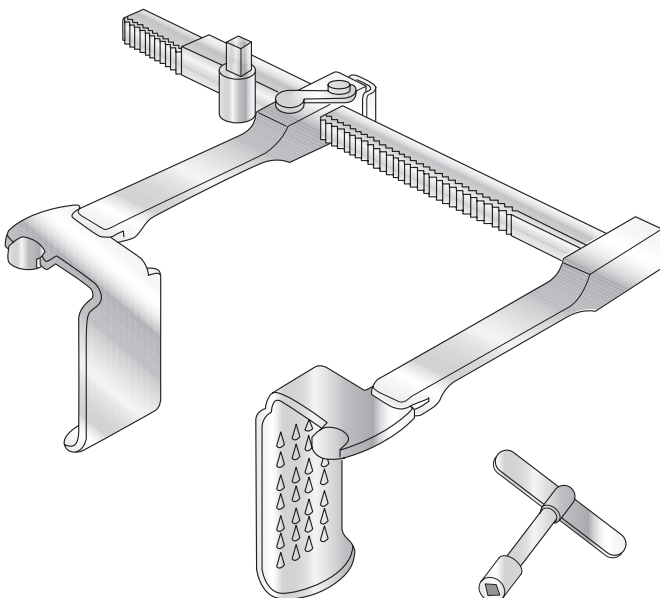

Code	Description
fos-T01	Complete, 2 of each blade, plus key
fos-T01a	25mm blade only, pair
fos-T01b	50mm blade only, pair
fos-T01c	75mm blade only, pair

Tuffier Rib Spreader

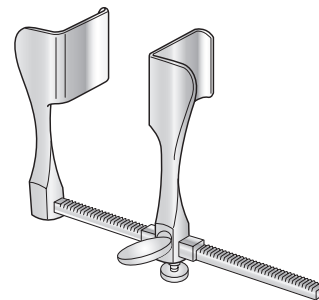

Code	Description
fos-T005	Blades 25mm deep x 19mm wide

Vehmehren Rib Holder and Costotome

Satin finish handles

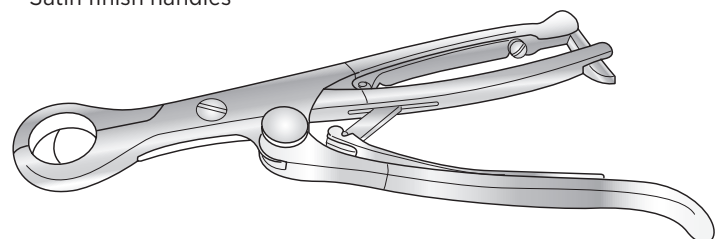

Code	Description
fos-T010	240mm long

Rib Shears and Lung Forceps

Giertz Rib Shears

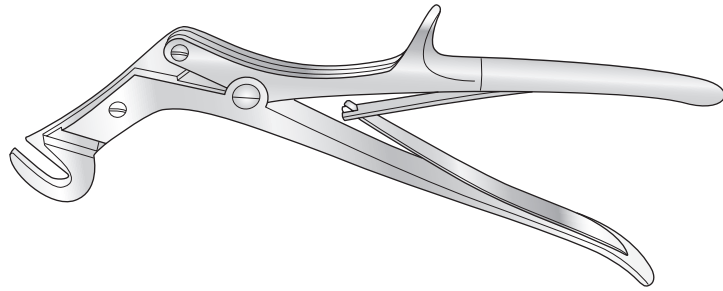

Code	Description
fos-T0041	270mm long

Tudor Edwards Rib Shears

Compound action, anterior

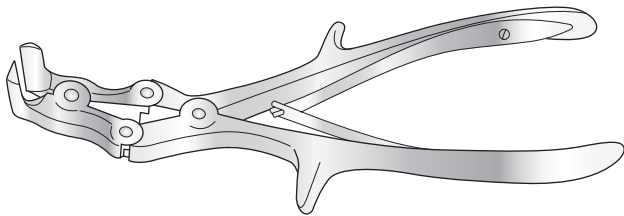

Code	Description
fos-T0042	235mm long

Mayo Lung Forceps

Fenestrated, semi-circular jaw, satin finish

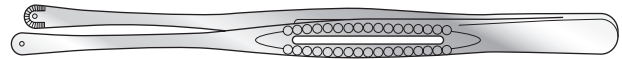

Code	Description
fos-T0014	230mm long

Tudor Edwards Periosteal Elevator

First rib, 175mm long

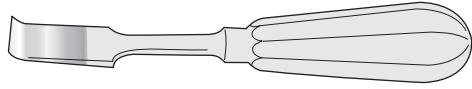

Code	Description
fos-T 10 09b	18mm wide

Doyen Periosteal Elevator

Satin finish handle

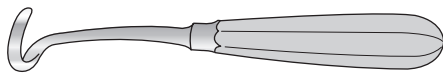

165mm long

Code	Description
fos-B/ 0 31	Right
fos-B/ 0 32	Left

180mm long

Code	Description
fos-B/ 0 256	Right
fos-B/ 0 255	Left

Blalock Hook

249mm long



Code	Description
fos-T 10 42	45° angle, 5mm tip
fos-T 10 43b	90° angle, 5mm tip

Ross (Papworth) Ventricular Sucker

33mm long

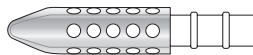

Code	Description
fos-T 10 01	Bullet

Ross (Papworth) Sump Sucker

42mm long

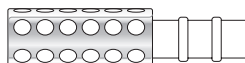

Code	Description
fos-T 10 02	Round end

Ross (Papworth) Flat Sucker

42mm long

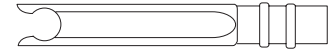

Code
fos-T 10 03

Ross Probe

200mm long

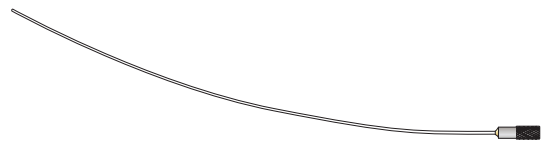

Code	Description
fos-T 10 55	1mm
fos-T 10 55a	1.5mm

Tibbs Arterial Cannula

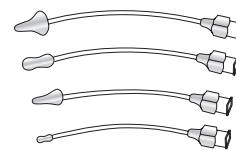

GU pattern

Code	Description	Code	Description
fos-TIB/001	Set of four	fos-TIB/006	Large cone
fos-TIB/002	Large cone	fos-TIB/007	Large olive
fos-TIB/003	Large olive	fos-TIB/008	Small cone
fos-TIB/004	Small cone	fos-TIB/009	Small olive
fos-TIB/005	Small olive	fos-TIB/010	Set of four

Urology

Retractors	229
Forceps	229
Urethral Sounds	230
Urethral Bougies	230
Miscellaneous	232



Walton Bladder Retractor

Code	Description
fos-UR/001	Parallel action, with convex lateral blades - 25mm x 70mm and curved central blade - 70mm x 215mm

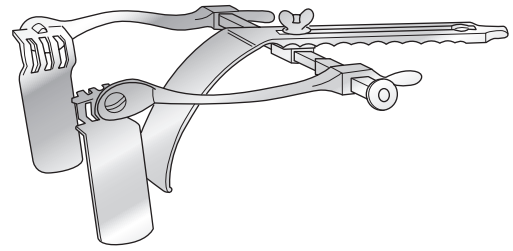

Thompson Walker Bladder Retractor

Code	Description
fos-UR/002	One posterior blade 95mm x 30mm, one anterior wall blade 175mm x 25mm tapering to 20mm, two pairs of lateral swivel blades, shallow: 55mm x 22mm, deep: 75mm x 25mm

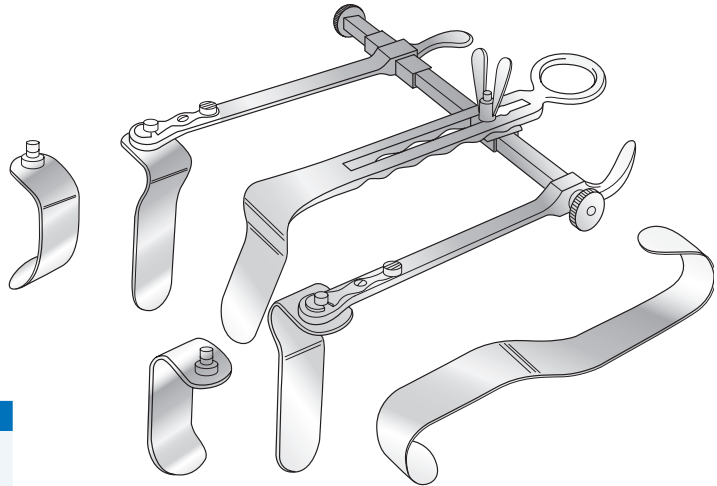

Millin Retropubic Retractor

Self retaining

Code
fos-UR/003

Millin retractor blades

Code	Description
fos-UR/004a	Short 25 x 55mm
fos-UR/004b	Long 25 x 80mm
fos-UR/004c	Centre 115 x 445mm

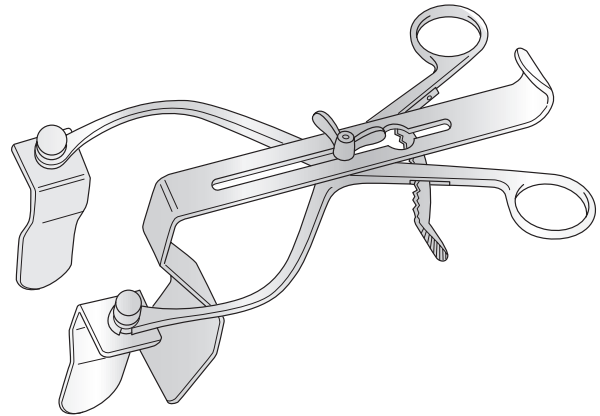

Millin Vulsellum Forceps

Screw joint for capsule, 225mm long

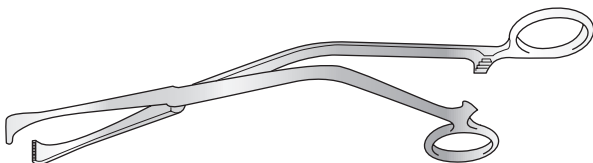

Code	Description
fos-UR/018	8-9 teeth, jaws 10mm wide

Millin Dissecting Spring Forceps

230mm long



Code	Description
fos-UR/014	3-4 teeth

Urethral Sounds and Bougies

Clutton Urethral Sounds

French gauge tapering, 265mm long



Code	Description
fos-UR/007	Set of 12 contains fos-UR/008 to fos-UR/008k

Code	Description
fos-UR/008	6 - 10
fos-UR/008a	8 - 12
fos-UR/008b	10 - 14
fos-UR/008c	12 - 16
fos-UR/008d	14 - 18
fos-UR/008e	16 - 20

Code	Description
fos-UR/008f	18 - 22
fos-UR/008g	20 - 24
fos-UR/008h	22 - 26
fos-UR/008i	24 - 28
fos-UR/008j	26 - 30
fos-UR/008k	28 - 32

Winsbury White Urethral Bougie

French gauge, child size, 175mm long

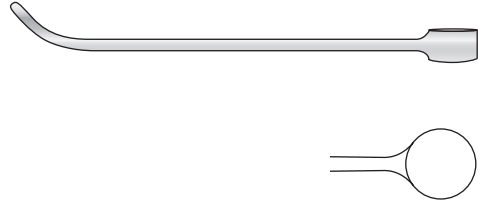

Code	Description
fos-UR/063	1-4 to 3-6
fos-UR/064	5-8 to 7-10
fos-UR/065	9-12 to 11-14

Lister Urethral Sounds

English gauge with olive ends, straight, 280mm long



Code	Description
fos-UR/010	0 - 1
fos-UR/010a	0 - 2
fos-UR/010b	0.5 - 3
fos-UR/010c	1 - 4
fos-UR/010d	2 - 5
fos-UR/010e	3 - 6

Code	Description
fos-UR/010f	4 - 7
fos-UR/010g	5 - 8
fos-UR/010h	6 - 9
fos-UR/010i	7 - 10
fos-UR/010j	8 - 11
fos-UR/010k	9 - 12

Canny Ryall Meatal Urethral Bougie

English gauge, double-ended, tapering
160mm long

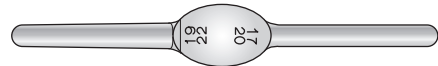

Code	Description
fos-UR/075	1-4 and 3-6
fos-UR/076	5-8 and 7-10
fos-UR/077	9-12 and 11-14
fos-UR/078	13-16 and 15-18
fos-UR/079	17-20 and 19-22
fos-UR/080	21-23 and 22-24
fos-UR/081	26-28 and 29-31

Buckston Browne Urethral Bougie

English gauge, 295mm long

Code	Description	Code	Description
fos-UR/020	4-6	fos-UR/027	11-13
fos-UR/021	5-7	fos-UR/028	12-14
fos-UR/022	6-8	fos-UR/029	13-15
fos-UR/023	7-9	fos-UR/030	14-16
fos-UR/024	8-10	fos-UR/031	15-17
fos-UR/025	9-11	fos-UR/032	16-18
fos-UR/026	10-12		



Clutton Urethral Bougie

French gauge, 260mm long

Code	Description	Code	Description
fos-UR/033	6 - 10	fos-UR/039	18 - 22
fos-UR/034	8 - 12	fos-UR/040	20 - 24
fos-UR/035	10 - 14	fos-UR/041	22 - 26
fos-UR/036	12 - 16	fos-UR/042	24 - 28
fos-UR/037	14 - 18	fos-UR/043	26 - 30
fos-UR/038	16 - 20	fos-UR/044	28 - 32

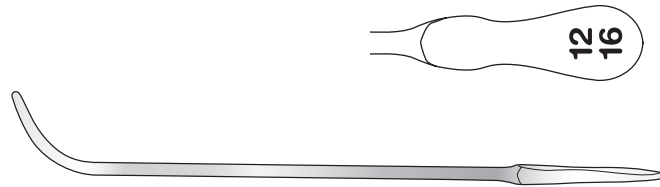

Guyon Urethral Bougie

French gauge, 275mm long

Code	Description
fos-UR/046	6-24

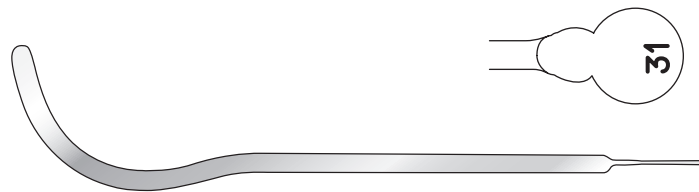

Lister Urethral Bougie

English gauge, 270mm long

Code	Description	Code	Description
fos-UR/047	4-7	fos-UR/053	10-13
fos-UR/048	5-8	fos-UR/054	11-14
fos-UR/049	6-9	fos-UR/055	12-15
fos-UR/050	7-10	fos-UR/056	13-16
fos-UR/051	8-11	fos-UR/057	14-17
fos-UR/052	9-12	fos-UR/058	15-18



Wyndham Powell Urethral Bougie

French gauge, 170mm long

Code	Description	Code	Description	Code	Description
fos-UR/059	12	fos-UR/062a	19	fos-UR/065	26
fos-UR/060	13	fos-UR/059b	20	fos-UR/066a	27
fos-UR/061	14	fos-UR/060b	21	fos-UR/067a	28
fos-UR/062	15	fos-UR/061b	22	fos-UR/068a	29
fos-UR/059a	16	fos-UR/062b	23	fos-UR/069a	30
fos-UR/060a	17	fos-UR/063	24	fos-UR/070a	31
fos-UR/061a	18	fos-UR/064	25	fos-UR/071a	32



Miscellaneous

Millin Bladder Neck Spreader

Self retaining, angled jaw

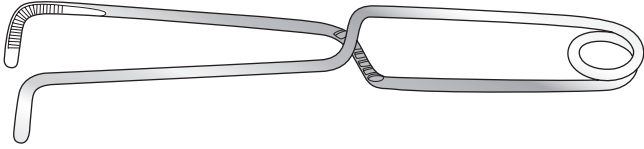

Code	Description
fos-UR/015	240mm long

Sieve

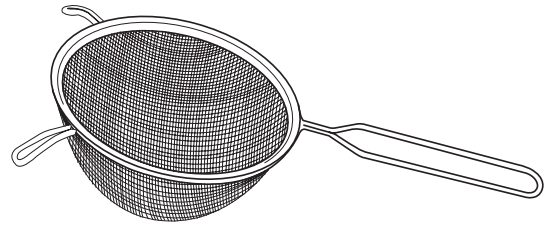

Code	Description
fos-GI/5071	203mm x 50mm





Beauty Instruments

Hair Cutting Scissors	235
Barber & Dressing Scissors	237
Nail & Cuticle Scissorst	238
Fancy Printed Scissors	242
Multi-Purpose Plastic Handle Scissors	244
Shaving Razors & Blades	246
Professional Thinning Scissors	247

Hair Cutting Scissors



Art No: SI-3111
Des : Professional Hair cutting Scissor Infused Multicolour Three rings.



Art No: TI-Hair-Sci-02
Des : Professional Hair cutting Scissor, Infused Multicolour, Three rings.



Art No: TI-Hair-Sci-03
Des : Professional hair cutting scissor. Infused Multicolour.



Art No: TI-Hair-Sci-04
Des : Professional hair cutting scissor Infused Multicolour.



Art No: TI-Hair-Sci-05
Des : Professional hair cutting scissor Infused Multicolour



Art No: TI-Hair-Sci-06
Des : Professional hair cutting scissor. Infused Multicolour.



Art No: TI-Hair-Sci-07
Des : Professional hair cutting scissor. Infused blue. Three Rings.



Art No: TI-Hair-Sci-08
Des : Professional hair cutting scissor. Infused blue.



Art No: TI-Hair-Sci-09
Des : Professional hair cutting scissor. Infused Multicolour.



Art No: TI-Hair-Sci-10
Des : Professional hair cutting scissor. Infused Multicolour.



Art No: TI-Hair-Sci-11
Des : Professional hair cutting scissor. Infused Multicolour.



Art No: TI-Hair-Sci-12
Des : Professional hair cutting scissor. Coloured. Three rings.

Hair Cutting Scissors



Art No: TI-Hair-Sci-12
Des : Professional hair cutting scissor. Gold plated.



Art No: TI-Hair-Sci-14
Des : Professional hair cutting scissor. Gold plated.



Art No: TI-Hair-Sci-15
Des : Professional hair cutting scissor.



Art No: TI-Hair-Sci-16
Des : Professional hair cutting scissor.



Art No: TI-Hair-Sci-17
Des : Forceps with



Art No: TI-Hair-Sci-18
Des : Ratchet Fixation



Art No: TI-Hair-Sci-19
Des : Forceps with



Art No: TI-Hair-Sci-20
Des : Thread Fixation



Art No: TI-Hair-Sci-21
Des : Forceps with



Art No: TI-Hair-Sci-22
Des : Thread Fixation



Art No: TI-Hair-Sci-23
Des : DINGMANN

Barber & Dressing Scissors



Art No: TI-Barber Sci 02
Des : Baber Scissor.
 Hand adjustable screw.



Art No: TI-Barber Sci 03
Des : Baber Scissor.



Art No: TI-Barber Sci 04
Des : Baber Scissor.
 Left Handed.



Art No: TI-Barber Sci 05
Des : Baber Scissor.



Art No: TI-Barber Sci 06
Des : Barber Scissor, with
 finger rest.



Art No: TI-Barber Sci 07
Des : Barber scissor, with
 finger rest.



Art No: TI-Barber Sci 07
Des : Barber scissor, with
 finger rest.



Art No: TI-Barber Sci 08
Des : Barber scissor.



Art No: TI-Barber Sci 09
Des : Barber scissor.
 Left handed.



Art No: TI-Barber Sci 10
Des : Barber scissor.
 Plastic Handle.



Art No: TI-Barber Sci 11
Des : Barber scissor.
 Plastic Handle.



Art No: TI-Barber Sci 12
Des : Barber scissor.
 Plastic Handle.

Nail & Cuticle Scissors



Art No: **SI-3149**
Des : Drilling chuck



Art No: **SI-3150**
Des : Nail and Cuticle



Art No: **SI-3151**
Des : Nail and Cuticle



Art No: **SI-3152**
Des : Nail and Cuticle



Art No: **SI-3153**
Des : Drilling Chuck



Art No: **SI-3154**
Des : Drilling Chuck



Art No: **SI-3155**
Des : Drilling Chuck



Art No: **SI-3156**
Des : Drilling Chuck



Art No: **SI-3157**
Des : Nail and Cuticle



Art No: **SI-3158**
Des : Wire tightener improved pattern



Art No: **SI-3159**
Des : Nail and Cuticle



Art No: **SI-3160**
Des : For wires up to 1.0 mm diam.

Nail & Cuticle Scissors



Art No: **SI-3161**
Des : SEMB



Art No: **SI-3162**
Des : Drilling chuck cannulated



Art No: **SI-3163**
Des : Nail and Cuticle



Art No: **SI-3164**
Des : Nail and Cuticle



Art No: **SI-3165**
Des : Drilling chuck cannulated



Art No: **SI-3158**
Des : For shanks up to 4.5 mm diam.



Art No: **SI-3167**
Des : Nail



Art No: **SI-TI-Nail Sci 20**
Des : Nail Scissor



Art No: **SI-TI-Nail Sci 21**
Des : FARABEUF



Art No: **SI-TI-Nail Sci 22**
Des : Drilling chuck cannulated



Art No: **SI-TI-Nail Sci 23**
Des : Nail and Cuticle



Art No: **SI-TI-Nail Sci 24**
Des : Nail and Cuticle

Nail & Cuticle Scissors



Art No: **TI-Nail Sci 25**
Des : FARABEUF



Art No: **TI-Nail Sci 26**
Des : FARABEUF-LAMBOTTE



Art No: **TI-Nail Sci 27**
Des : Wire guides



Art No: **TI-Nail Sci 28**
Des : Goldmann Fox



Art No: **TI-Nail Sci 29**
Des : Cerclage Instruments



Art No: **TI-Nail Sci 30**
Des : Goldmann Fox



Art No: **TI-Nail Sci 31**
Des : Cerclage Instruments



Art No: **TI-Nail Sci 32**
Des : Fine Scissor



Art No: **TI-Barber Sci 13**
Des : Fine Scissor



Art No: **TI-Nail Sci 34**
Des : Cerclage Instruments



Art No: **TI-Nail Sci 35**
Des : Cerclage Instruments



Art No: **TI-Nail Sci 36**
Des : Cerclage Instruments

Nail & Cuticle Scissors



Art No: TI-Nail Sci 37
Des : Cerclage Instruments



Art No: TI-Nail Sci 38
Des : Scissors with Tungsten Carbide Inserts

Fancy Printed Scissors



Art No: TI-Fancy Sci 01
Des : Ragnell



Art No: TI-Fancy Sci 02
Des : Wire tightener



Art No: TI-Fancy Sci 03
Des : Wire twister



Art No: TI-Fancy Sci 04
Des : Wire catcher



Art No: TI-Fancy Sci 05
Des : Probe, cannulated



Art No: TI-Fancy Sci 06
Des : Holding forceps for cerclage



Art No: TI-Fancy Sci 07
Des : Fancy Cuticle Scissor



Art No: TI-Fancy Sci 08
Des : Fancy Cuticle Scissor



Art No: TI-Fancy Sci 09
Des : Wire tightening pliers



Art No: TI-Fancy Sci 010
Des : Ligature pliers



Art No: TI-Fancy Sci 011
Des : Wire tightening pliers



Art No: TI-Fancy Sci 012
Des : Fancy Cuticle Scissor

Fancy Printed Scissors



Art No: TI-H Hold Sci 01
Des : House Hold Scissor.



Art No: TI-H Hold Sci 02
Des : Paper Cutting Scissor.



Art No: TI-H Hold Sci 03
Des : G. T Scissor.



Art No: TI-H Hold Sci 04
Des : Paper Cutting Scissor.



Art No: TI-H Hold Sci 05
Des : Taylor Scissor.



Art No: TI-H Hold Sci 06
Des : Taylor Scissor sharp point..



Art No: TI-H Hold Sci 07
Des : Taylor Scissor.



Art No: TI-H Hold Sci 08
Des : Taylor Scissor sharp point.

Multi-Purpose Plastic Handle Scissors



Art No: SI-TI-H Hold Sci 09
Des : House Hold Scissor.



Art No: TI-H Hold Sci 10
Des : House Hold Scissor.



Art No: TI-H Hold Sci 11
Des : House Hold Scissor.



Art No: TI-H Hold Sci 12
Des : House Hold Scissor.



Art No: TI-H Hold Sci 13
Des : House Hold Scissor.



Art No: TI-H Hold Sci 14
Des : House Hold Scissor.



Art No: TI-Plastic Sci 01
Des : Paper Scissor.



Art No: TI-Plastic Sci 02
Des : Light weight plastic handle scissor.



Art No: TI-Plastic Sci 03
Des : Plastic Handle Scissor



Art No: TI-Plastic Sci 04
Des : School Baby Scissor

Multi-Purpose Plastic Handle Scissors



Art No: TI-Plastic Sci 05
Des : Light Weight plastic handle Taylor Scissor.



Art No: TI-Plastic Sci 06
Des : Utility Scissor.



Art No: TI-Plastic Sci 07
Des : Electric wire Scissor with plastic handle



Art No: TI-Plastic Sci 08
Des : For soft wire

Shaving Razors & Blades



Art No: TI-Razor-01
Des : Shaving Razors With Plastic Handle and removable Blade.



Art No: TI-Razor-02
Des : Shaving Razors With Plastic Handle and removable Blade.



Art No: TI-Razor-03
Des : Shaving Razors With Plastic Handle.



Art No: TI-Gift-01
Des : Eye Brow Tweezer with balister packing.



Art No: TI-Gift-02
Des : Nail Scissor with balister packing.



Art No: TI-Gift-03
Des : Cuticle nipper with balister packing.



Art No: TI-Gift-04
Des : (Razor Edge) with high quality gift pack.



Art No: Beauty kit
Des : Beauty kit with 9 pieces.

Professional Thinning Scissors



Art No: TI-Thinning Sci 01

Des : Professional Thinning Scissors. One blade razor and one blade teeth. Infused multicolour



Art No: TI-Thinning Sci 02

Des : Professional Thinning Scissors. One blade razor and one blade teeth. Infused multicolour.



Art No: TI-Thinning Sci 03

Des : Professional Thinning Scissors. One blade razor and one blade teeth. Infused multicolour.



Art No: TI-Thinning Sci 04

Des : Professional Thinning Scissors. One blade razor and one blade teeth. Infused multicolour.



Art No: TI-Thinning Sci 05

Des : Professional Thinning Scissors. Double blade teeth.



Art No: TI-Thinning Sci 06

Des : Dressing Thinning Scissors. Double blade teeth.



Art No: TI-Thinning Sci 07

Des : Thinning Scissor. Plastic handle. One blade teeth



Art No: TI-Thinning Sci 08

Des : Professional Thinning Scissor. Single blade 7 teeth up to 32. One blade razor.